



ESCUELA TÉCNICA SUPERIOR DE INGENIERÍA (ICAI)  
MASTERS IN THE ELECTRIC POWER INDUSTRY

# IMPACT OF IMBALANCE NETTING AND PRICED TSO NEEDS ON CROSS-BORDER EXCHANGE OF BALANCING ENERGY

Author: María Arias González  
Supervisor: Rafael González Hombrados

Madrid  
July 2017

# Master's Thesis Presentation Authorization

THE STUDENT:

María Arias González

.....  

THE SUPERVISOR

Rafael González Hombrados

Signed:  ..... Date: 30 / 06 / 2017

THE CO-SUPERVISOR

Ricardo Heras Fernández-Albañil

Signed:  ..... Date: 30 / 06 / 2017

Authorization of the Master's Thesis Coordinator

Dr. Luis Olmos Camacho

Signed: ..... Date: ..... / ..... / .....

ESCUELA TÉCNICA SUPERIOR DE INGENIERÍA (ICAI)  
MASTERS IN THE ELECTRIC POWER INDUSTRY

**IMPACT OF IMBALANCE NETTING AND  
PRICED TSO NEEDS ON CROSS-BORDER  
EXCHANGE OF BALANCING ENERGY**

Author: María Arias González  
Supervisor: Rafael González Hombrados



## ABSTRACT

---

During the last years Europe's energy policies has been geared for the achievement of three main objectives: energy in the European Union should be affordable and competitively priced, environmentally sustainable and secure for everybody. Hence, a well-integrated and competitive internal energy market plays a key role for the consecution of these objectives in a cost-effective way. Although significant progress has been carried out regarding market integration, energy systems still maintain a position in which Member States try to be self-sufficient by using the own services and energy sources. However, this behaviour is no longer sensible or efficient.

Therefore, a European Energy Union is one of the European Commission's priorities. Under this changing environment, three legislative packages and a legislative proposal have adopted between 1996 and 2016, being the last published the so called EU Winter Package "Clean Energy for All Europeans". This set of measures aims to keep competitiveness within the European Union, since clean energy transition is changing global energy markets. However, this document will partially focus on the third legislative package (2009), known as Third Energy Package. This package set out the framework for a series of EU Network Codes to be developed by the European Transmission Systems Operators, working within Framework Guidelines developed by Regulators in the Agency for the Cooperation of Energy Regulators (ACER). Considering the aim of this Master's Thesis, this document will consider certain specifications of the Network Code on Electricity Balancing (NC EB) given the importance of ensuring European security of supply and the related economic consequences that consumers have to bear on with. The National Regulatory Authorities, ACER and national EU stakeholders, have been committed to work on early implementation of the NC EB through the establishment of a dedicated consultative body at European Level (the so-called Balancing Stakeholder Group) and the setting up of regional pilot projects. Among these projects, it is important to highlight the "Trans European Replacement Reserves (TERRE) Project", which is the core of this document.

In order to comply with the legal EU framework and adapt its strategies before the implementation of the aforementioned project, the company has recently developed a long-term forecasting tool based on some of the requirements specified in it. However, some key issues are still not satisfied. For this reason, this document will focus on the improvements and changes implemented in the previous company's simulation tool.

## RESUMEN

---

Durante los últimos años, la política energética europea ha estado encaminada a alcanzar principalmente tres objetivos: la energía en la Unión Europea debe ser asequible, sostenible medioambientalmente y segura para todo el mundo. Así pues, un mercado energético interno, competitivo y correctamente integrado, es un requisito fundamental para alcanzar económicamente los objetivos previamente mencionados. A pesar de que se ha llevado a cabo un progreso significativo en la integración de dichos mercados, los sistemas energéticos europeos todavía mantienen una posición en la cual los estados miembros intentan ser autosuficientes en su generación eléctrica. Sin embargo, esta situación ya no resulta eficiente.

Así pues, una de las prioridades de la Unión Europea es la Unión Energética Europea. Ante esta situación cambiante, tres paquetes legislativos y una propuesta legislativa han sido adoptados entre 1996 y 2016, siendo el último publicado el conocido como el Paquete de Invierno, “Energía limpia para todos los europeos”. Este conjunto de medidas pretende mantener la Unión Europea competitiva, ya que la actual transición hacia energías limpias está cambiando los mercados energéticos globales. Sin embargo, este documento se centrará parcialmente en el tercer paquete legislativo (2009) conocido como “Third Energy Package”. Este paquete establece una serie de regulaciones conocidas como Network Codes, desarrolladas por los reguladores en ACER. Teniendo en cuenta el objetivo de este Trabajo de Fin de Master, este documento se centrará en algunas de las especificaciones establecidas en el Network Code para Energías Balance, de suma importancia dadas sus implicaciones en cuando a seguridad de suministro y su impacto económico en los consumidores. Las autoridades reguladores nacionales, ACER y los diferentes stakeholders de la Unión Europea, han estado comprometidos en la pronta implementación de dicho Network Code gracias a la creación de un organismo consultativo a nivel europeo (el llamado “Balancing Stakeholder Group”) y al desarrollo de proyectos piloto a nivel regional. Entre estos proyectos, es importante destacar el conocido como “Trans European Replacement Reserves (TERRE) Project”, el cual conformará la esencia de este documento.

Con el fin de cumplir con el marco legal europeo y adaptar de forma previa sus estrategias ante la futura implementación del ya mencionado proyecto, la empresa ha desarrollado recientemente una herramienta de previsión de largo plazo basada en algunos de los requisitos especificados en dicho proyecto. Sin embargo, algunas cuestiones clave no han sido todavía tratadas. Por esta razón, este documento se centrará en los cambios y mejoras implementados en la herramienta de simulación previa.

# TABLE OF CONTENTS

<b>ABSTRACT</b>	<b>5</b>
<b>RESUMEN</b>	<b>6</b>
<b>LIST OF FIGURES</b>	<b>9</b>
<b>LIST OF CHARTS</b>	<b>10</b>
<b>1. INTRODUCTION</b>	<b>11</b>
1.1 MOTIVATION. THE EUROPEAN ENERGY TRANSITION.	11
1.2 PRELIMINARY WORK	12
1.3 OBJECTIVES	13
1.4 REPORT STRUCTURE	13
<b>2. STATE OF ART</b>	<b>15</b>
2.1 LEGAL FRAMEWORK	15
2.2 SCOPE OF THE TERRE PROJECT	17
2.3 TERRE MAIN SPECIFICATIONS	19
2.3.1 TERRE PRECURSOR	19
2.3.2 TERRE DESIGN	20
2.4 FUTURE PROJECTS. MARI-PROJECT	29
<b>3. LPRM-TERRE MODEL</b>	<b>30</b>
3.1 ENDESA'S LONG-TERM FORECASTING TOOLS.	30
3.2 INPUT DATA	31
3.2.1 COMPETITION PATTERNS	31
3.2.2 AVAILABLE RESOURCES	32
3.3 UPWARD/DOWNWARD CURVES	32
3.3.1 BIDS FORMAT	32
3.3.2 IMBALANCES CURVES. TRANSMISSION SYSTEM OPERATORS' PRICED IMBALANCES	33
3.4 DETERMINATION OF CROSS-BORDER CAPACITY	34
3.5 NETTING METHOD OF IMBALANCE NEEDS	36
3.5.1 PRE-NETTING OF IMBALANCE NEEDS. EXPLICITLY NETTING	36
3.5.2. IMPLICITLY NETTING	37
3.6 CLEARING PROCESS	40
3.6.1 MARKET CLEARING ALGORITHM. TWO-STAGE CLEARING PROCESS	40
3.6.2 MARKET CLEARING ALGORITHM. ONE-STAGE CLEARING PROCESS	46
<b>4. ANALYSIS OF SCENARIOS</b>	<b>50</b>

<b>4.1</b>	<b>PRE-NETTING OF IMBALANCES VS. BASE CASE</b>	<b>50</b>
<b>4.2</b>	<b>PRICING IMBALANCES VS. BASE CASE.</b>	<b>54</b>
<b>4.3</b>	<b>PRE-NETTING AND PRICING IMBALANCES VS. BASE CASE</b>	<b>56</b>
<b>4.4</b>	<b>COMPARISON BETWEEN ALL SCENARIOS</b>	<b>60</b>
<b>4.5</b>	<b>ONE-STAGE CLEARING PROCESS VS. TWO-STAGE CLEARING PROCESS.</b>	<b>61</b>
<b>5.</b>	<b><u>CONCLUSIONS</u></b>	<b>65</b>
<b>5.1</b>	<b>FUTURE PROJECTS</b>	<b>65</b>
	<b><u>REFERENCES</u></b>	<b>67</b>
	<b><u>LIST OF ABBREVIATIONS</u></b>	<b>68</b>
	<b><u>ANNEX A</u></b>	<b>70</b>



## List of Figures

FIGURE 1: ANCILLARY SERVICES PRODUCTS.-----	16
FIGURE 2: ENTSO-E BALANCING PILOT PROJECTS -----	17
FIGURE 3: TERRE DESIGN PHASES -----	18
FIGURE 4: TERRE PARTICIPANTS.-----	19
FIGURE 5: PROPOSAL OF THE ROADMAP FOR THE INTEGRATION OF BALANCING MARKETS.-----	20
FIGURE 6: LIBRA PLATFORM FLOWS -----	21
FIGURE 7: OVERVIEW OF DIFFERENT MANUAL RESERVES BALANCING MARKETS IN TERRE PARTICIPANTS. -	22
FIGURE 8: TERRE BASIC PRODUCT STANDARD CHARACTERISTICS-----	23
FIGURE 9: TSOs IMBALANCE NEEDS CHARACTERISTICS-----	24
FIGURE 10: SIMPLIFIED SCHEME FOR ONE CMO AND ONE-STAGE CLEARING PROCESS. -----	26
FIGURE 11: TERRE PROCESS TIMELINE. -----	28
FIGURE 12: MARI-PROJECT PARTICIPANTS-----	29
FIGURE 13:COMPANYS FORECASTING TOOLS.-----	30
FIGURE 14: CLEARED POINTS AFTER APPLYING AN EXPLICATIVE VARIABLE -----	32
FIGURE 15: FRENCH SYSTEM CLEARED PRICES/VOLUMES -----	32
FIGURE 16: BIDS FORMAT IN LPRM-MODEL -----	33
FIGURE 17: TSOs PRICING IMBALANCES. STRATEGIES -----	34
FIGURE 18: FLOWCHART FOR THE DETERMINATION OF CROSS-BORDER CAPACITY -----	35
FIGURE 19: EXAMPLE OF THE NETTING PROCESS-----	36
FIGURE 20: FORECASTING TOOL INTERFACE. NETTING RESULTS -----	37
FIGURE 21: AGGREGATION OF UPWARD/DOWNWARD CURVES -----	38
FIGURE 22: COMPARISON AMONG IMPLICITLY NETTING VS. PRE-NETTING. EFFECT ON SOCIAL WELFARE --	38
FIGURE 23: FLOWCHART FOR PRE-NETTING IMBALANCES-----	39
FIGURE 24: COMPARISON OF ORIGINAL CLEARING PROCESS VS. TWO-STAGE CLEARING PROCESS-----	40
FIGURE 25: TWO-STAGE CLEARING PROCESS IDEAL SOLUTION-----	41
FIGURE 26: MAXIMIZED SOCIAL WELFARE IN THE TWO-STAGE CLEARING PROCESS-----	41
FIGURE 27: UNAVAILABLE INTERCONNECTIONS. CHANGE OF THE INITIALLY CLEARED CURVE -----	42
FIGURE 28: MARKET SPLITTING. MARGINAL PRICES CASE 1 -----	42
FIGURE 29: MARKET SPLITTING. MARGINAL PRICES CASE 2 -----	42
FIGURE 30: OFFERS STILL AVAILABLE AFTER THE CLEARING PROCESS -----	43
FIGURE 31: TWO-STAGE CLEARING PROCESS WITH INFINITE INTERCONNECTIONS. FLOWCHART-----	44
FIGURE 32: TWO-STAGE CLEARING PROCESS WITH INTERCONNECTIONS. FLOWCHART-----	45
FIGURE 33: ONE-STAGE CLEARING PROCESS IDEAL SOLUTION. -----	46
FIGURE 34: ONE-STAGE CLEARING PROCESS. CHECKING ORIGIN OF OFFERS/IMBALANCES-----	46
FIGURE 35: SUBROUTINE FOR IMPLICITLY NETTING -----	47
FIGURE 36: CASUISTRY WITH TWO SERVICES PROVIDERS IN THE CLEARING PROCESS-----	47
FIGURE 37: INTERCONNECTIONS CONGESTION. CHANGE IN THE INITIALLY CLEARED CURVES -----	47
FIGURE 38: MARKET SPLITTING. SYSTEMS' MARGINAL PRICES-----	48
FIGURE 39: ONE-STAGE CLEARING PROCESS FLOWCHART-----	49
FIGURE 40: PRE-NETTING VS. BASE CASE. UPWARD IMBALANCES IN SPAIN-----	51
FIGURE 41: PRE-NETTING VS. BASE CASE. DOWNWARD IMBALANCES IN SPAIN-----	51
FIGURE 42: PRE-NETTING VS. BASE CASE. UPWARD IMBALANCES IN PORTUGAL -----	52
FIGURE 43: PRE-NETTING VS. BASE CASE. DOWNWARD IMBALANCES IN PORTUGAL-----	52
FIGURE 44: PRE-NETTING VS. BASE CASE. UPWARD IMBALANCES IN FRANCE-----	52

FIGURE 45: PRE-NETTING VS. BASE CASE. DOWNWARD IMBALANCES IN FRANCE-----	53
FIGURE 46: PRE-NETTING VS. BASE CASE. PORTUGAL CASE -----	53
FIGURE 47: PRICING IMBALANCES VS. BASE CASE. UPWARD IMBALANCES IN SPAIN -----	54
FIGURE 48: PRICING IMBALANCES VS. BASE CASE. DOWNWARD IMBALANCES IN SPAIN -----	55
FIGURE 49: PRICING IMBALANCES VS. BASE CASE. UPWARD IMBALANCES IN PORTUGAL-----	55
FIGURE 50: PRICING IMBALANCES VS. BASE CASE. DOWNWARD IMBALANCES IN PORTUGAL-----	55
FIGURE 51: PRICING IMBALANCES VS. BASE CASE. UPWARD IMBALANCES IN FRANCE -----	56
FIGURE 52: PRICING IMBALANCES VS. BASE CASE. DOWNWARD IMBALANCES IN FRANCE -----	56
FIGURE 53:PRE-NETTING AND PRICING IMBALANCES VS. BASE CASE. DOWNWARD IMBALANCES IN SPAIN -	57
FIGURE 54: PRE-NETTING AND PRICING IMBALANCES VS. BASE CASE. UPWARD IMBALANCES IN PORTUGAL -----	58
FIGURE 55: PRE-NETTING AND PRICING IMBALANCES VS. BASE CASE. UPWARD IMBALANCES IN PORTUGAL -----	58
FIGURE 56: PRE-NETTING AND PRICING IMBALANCES VS. BASE CASE. DOWNWARD IMBALANCES IN PORTUGAL -----	58
FIGURE 57: PRE-NETTING AND PRICING IMBALANCES VS. BASE CASE. UPWARD IMBALANCES IN FRANCE--	59
FIGURE 58: PRE-NETTING AND PRICING IMBALANCES VS. BASE CASE. DOWNWARD IMBALANCES IN FRANCE -----	59
FIGURE 59: PRE-NETTING AND PRICING IMBALANCES VS. BASE CASE. UPWARD RESULTS PER SYSTEM ----	60
FIGURE 60: ALL SCENARIOS ANNUAL UPWARD VOLUMES -----	60
FIGURE 61: ALL SCENARIOS ANNUAL DOWNWARD IMBALANCES-----	61
FIGURE 62: REDUCTION OF NETTING DUE TO COMPETITIVE SERVICE PROVIDERS AND PRICING IMBALANCES -----	63
FIGURE 63: COMPARISON AMONG TERRE PRODUCT AND CURRENT LOCAL RR PRODUCTS-----	70

## List of charts

CHART 1: IMPACT OF PRE-NETTING IMBALANCES VS. BASE CASE.....	51
CHART 2: IMPACT OF PRICING TSOs NEEDS VS, BASE CASE.....	54
CHART 3: IMPACT OF PRE-NETTING AND PRICING VS. BASE CASE.....	57
CHART 4: COMPARISON BETWEEN PRE-NETTING AND PRICING STRATEGIES AMONG ONE/TWO-STAGE .....	61
CHART 5: COMPARISON BETWEEN PRE-NETTING AND PRICING STRATEGIES AMONG ONE/TWO-STAGE .....	62

# 1. INTRODUCTION

---

## 1.1 Motivation. The European Energy Transition.

The European Union's Energy Union Strategy is based on the desire to achieve, in an affordable way, a fundamental transformation of Europe's energy systems. The policy areas, which shape this strategy, are made up of five interrelated dimensions, which can be summarised as follows:

- **Security, solidarity and trust**, which are achieved through diversifying energy sources, suppliers and routes. In addition, Member States, Transmission System Operators, the energy industry and all other stakeholders must work jointly to ensure energy security in Europe [1].
- **A fully-integrated energy market.** [2] The aim is the achievement of a resilient and integrated energy market across the EU, enabling the free flow of electricity across the EU. For doing that it is necessary an adequate infrastructure, without technical or regulatory barriers. Only then competitiveness among market agents is achieved.
- **Energy efficiency**, which will reduce our dependence on energy imports, reduce emissions and drive jobs and growth. In addition, it is a key issue when it comes to the moderation of energy demand.
- **Climate action. Decarbonising the economy.** [3] An ambitious climate policy is fundamental in current European energy policies. The EU aims to become the world leader in renewable energy. For doing that European regulators has also set a target of at least 27% for the share of renewable energy consumed in the EU in 2030. Regarding greenhouse gas (GHG) emissions, the EU has the commitment of reduce at least 40% in GHG compared to 1990 levels.
- **Research, innovation and competitiveness.** These are fundamental in order to support technological advances in low carbon and clean energy technologies. Actions for the achievement of this strategy could be grouped in the following core priorities: 1)Being the world leader in developing the next renewable energy technologies; 2)Facilitating the participation of end-users in this energy transition (i.e. smart home appliances); 3)Efficient energy systems; 4)More sustainable transport systems to increase energy efficiency and reduce greenhouse gas emissions. [1]

Under this framework, mainly characterized by the increasing development of intermittent power generation (wind and solar) and the expected evolutions at the demand side (demand response, electric vehicles), balancing services play a key role and they are expected to grow, particularly to manage short-term fluctuations in demand and supply and to ensure system reliability [4]. This increasing need for balancing services can be more efficiently addressed by integrated balancing markets. In this context, several initiatives –pilot projects– have been taken at regional level: projects for *Automatic Frequency Restoration*, for *Frequency Containment Reserve*, for *Manual Frequency Restoration*, for *Imbalance Netting* and for *Replacement Reserves*. [5]

Hence, under this changing environment, electricity companies must adapt its strategies in order to be prepared to future circumstances. One way of doing it is by developing long-term forecasting tools. For this reason, the core of this document will be based on the explanation of an algorithm about one of the aforementioned pilot projects for *Replacement Reserves*, which has been developed by the author of this document.

## 1.2 Preliminary Work

The development of this Master's Thesis has been carried out within the area of Strategic Short-Term Planning and Ancillary Services (SSTP-AASS) of the Energy Management Department of Endesa, one of the biggest Spanish electric utilities. This area is in charge of carrying out market analysis for the definition of bidding strategies, planning and budget purposes. For this reason, the development of forecasting tools is very important.

During the last years, previous work in this department has also been accomplished by ICAI's students. Starting from forecasting tools for Secondary Reserves Markets to the most innovative and recent projects, such as the LPRM-TERRE Model –see section 3. This initial forecasting tool was developed last year by a Master's in the Electric Power Industry student<sup>1</sup>, however, given the expected implementation of this project in 2019, it has been necessary the adoption of further changes not only in the different algorithms, but also in the program's interface. Next sections will explain the introduced changes and the functioning of the new tool.

---

<sup>1</sup> Ana García Gómez. European cross-border exchange of balancing energy: simulation and analysis

## 1.3 Objectives

### 1) Understanding the current situation of the European Energy System.

- 1.1) Main characteristics of the “Third Energy Package”.
- 1.2) Objectives of the Electricity Balancing Guidelines and Network Codes.
- 1.3) Focusing on the Electricity Balancing Network Code (EB NC).

### 2) Understanding the initial long-term forecasting tool in order to implement the proper changes and comply with the specific requirements of the TERRE Project.

### 3) Developing the new simulation tool according to the following procedure:

- 2.1) Changing the hourly upwards and downwards curves.
- 2.2) Creating elastic TSOs demand curves.
- 2.3) Carrying out two clearing processes, one for upwards activations and the other for downwards activations.

2.3.1) Clearing the process –in two-stages– with the initial algorithm but adding the option of previously netting system imbalance needs.

2.3.2) Clearing the process –in two-stages– with the new algorithm but adding the option of previously netting the imbalance needs.

2.3.2) Comparing the results between these two clearing processes.

2.4) Carrying out one-stage clearing process, combining the TSOs upward needs with the generators downward offers and, on the other hand, the TSOs downward needs with the generators upward offers.

2.4.1) Comparing the new results with the ones obtained in the two clearing processes.

### 4) Running several scenarios for doing qualitative and quantitative assessment of final results.

## 1.4 Report Structure

First section will provide the reader a better understanding about the current situation of the European Energy System. Given that this current changing environment needs to be supported with an adequate legal framework, section two will briefly explain the main Regulations and Directives, which drive the European Energy Policies.

The core of the document starts in section three, which aims to describe each feature of the model. It will explain the methodology applied from the input data to the latest results. Since the company already had an initial TERRE-Model, the section will account for the implemented changes as well as the improvements in the different subroutines.

Fourth section will include results and explanations about the scenarios proposed by the SSTP-AASS Department. These results will be mainly focused on the effect that pricing TSOs imbalances may have in final results. Interconnections and pre-netting will also have an important effect which must be considered.

The document will be conclude with some comments about the results, the gained experience during the internship, the problems that could arise during the development of the Master's Thesis and future developments concerning the model.

## 2. STATE OF ART

---

### 2.1 Legal Framework

Harmonisation and liberalisation of European energy markets has led to the adoption of three legislative packages of measures between 1996 and 2016, which were mainly focused on a EU-wide regulation, market access, transparency, customer empowerment and the consecution of adequate levels of supply [6]. The First Energy Package was superseded in 2003 by the Second Energy and ,in April 2009, a Third legislative Package –the so called Third Energy Package– came into force amending previous packages with the aim of further liberalising the internal electricity and gas market and completing the integration of the internal energy market. Concerning former legislative package and taking into account the purpose of this Master’s Thesis, we are going to merely focus on Regulation (EC) No 714/2009 (Article 6(2)) [7], Electricity Regulation and Directive 2009/72/EC [8], whose main objectives are the contribution to non-discrimination and effective competition, the efficient functioning of the internal market in electricity and the importance of cross-border trade in security of supply. In addition, one can assume that the achievement of the EU’s targets for penetration of renewable generation, as well as ensuring the optimal management and coordinated operation of the European electricity transmission networks are also fundamental.

To achieve these objectives, the aforementioned Regulations include the development of Network Codes. Under this framework, the recently approved<sup>2</sup> ACER’s Network Code on Electricity Balancing (NC EB), as well as a qualified recommendation to adopt this code published by ACER (QR on NC EB), have paved the way for the integration of European electricity balancing markets. In parallel to these processes, the National Regulatory Authorities (hereafter NRAs), ACER and national EU stakeholders, have been committed to work on the early implementation of the NC EB through the establishment of a European consultative body, known as Balancing Stakeholder Group at European Level, and the setting up of regional Pilot Projects. Therefore, ENTSO-E<sup>3</sup> has proposed several cross-border pilot projects with the purpose of:

- Testing the feasibility of the Electricity Target Model and the principles established in the Framework Guidelines (FGs) and Network Codes (NCs).

---

<sup>2</sup> The draft Regulation establishing a guideline on electricity balancing (EB) received a positive vote in comitology on 16 March 2017.

<sup>3</sup> ENTSO-E stands for the European Network of Transmission System Operators for electricity.

- Identifying and overcoming barriers that may appear during the design and its later implementation.
- Monitoring the benefits at different levels, taking into account the effect on the social welfare.
- Gathering information about Transmission System Operators and EU stakeholders.
- Evaluating the impact of the project implementation;
- Reporting on the experience gained.

Before starting the description of the previously mentioned Electricity Balancing Pilot Projects, it is important to describe the type of balancing services/products which are used in these markets:

- Primary Regulation or Frequency Containment Reserves (FCR);
- Secondary Regulation or Automatic Frequency Restoration (aFRR);
- Tertiary Regulation or Manual Frequency Restoration Reserves (mFRR); and
- Replacement Reserves (RR).

The following graph provides a simplified representation regarding these products timeframes.

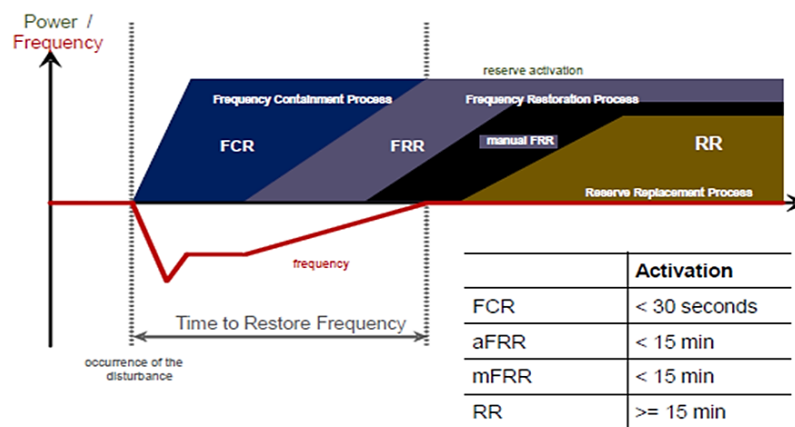

Figure 1: Ancillary Services Products.  
Source: ENTSO-E

Although this document will mention some of these products and the Pilot Projects involved in their use, this document will only describe Replacement Reserves products. In the following section, the reader will find the definition of this type of balancing product in accordance to the NC EB.

Among the current eight Cross-Border Pilot Projects on Electricity Balancing –see *below Figures*–, this document focuses on the “*Trans European Replacement Reserves Exchange (TERRE) Project*”, a voluntary regional initiative from



Transmission System Operators dedicated to the exchange of balancing energy of Replacement Reserves (hereafter “RR”).

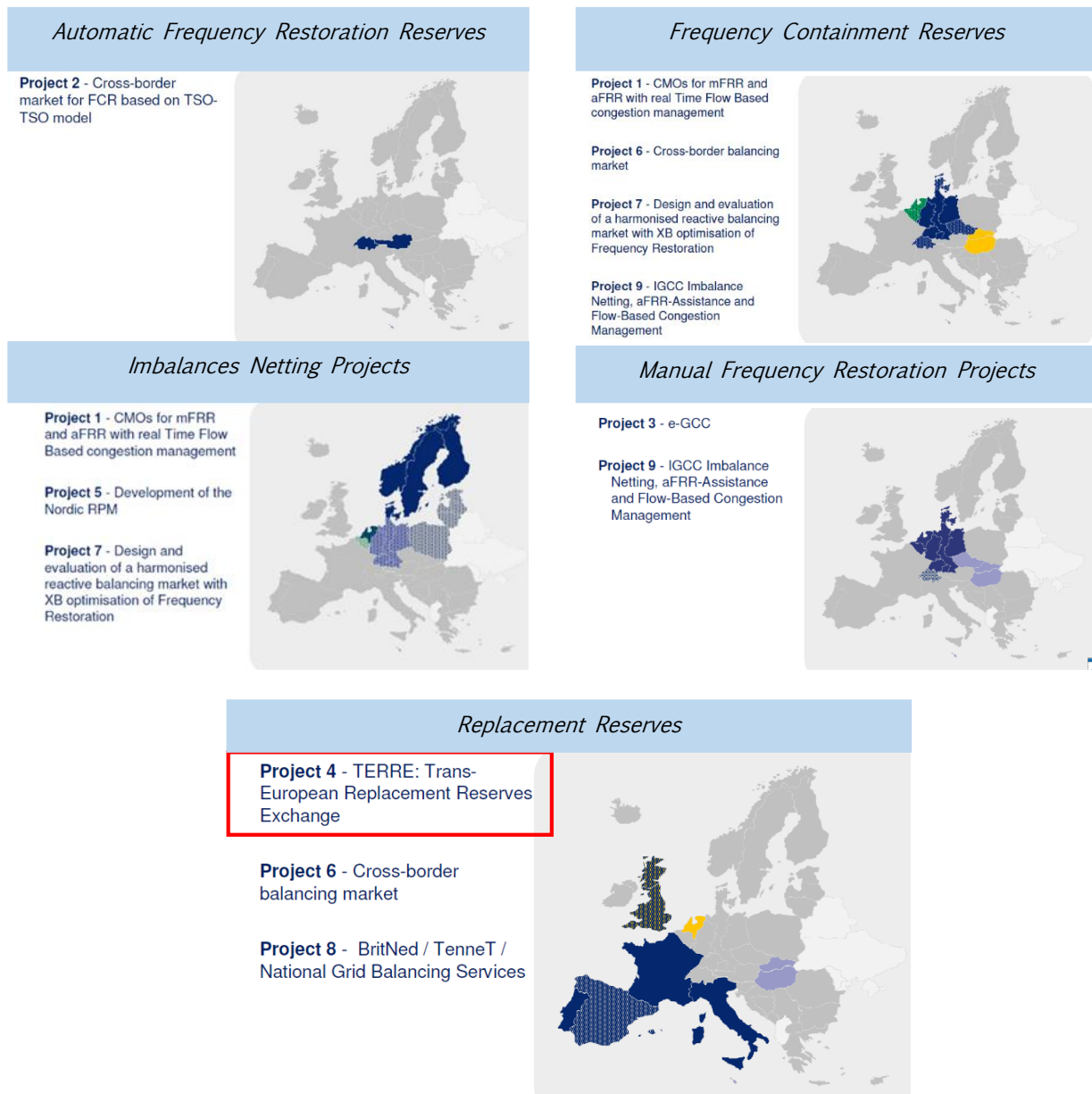

Figure 2: ENTSO-E Balancing Pilot Projects  
Source: National Grid

## 2.2 Scope of the TERRE project

Following the definition in Article 3 of the Guideline on System Operation (SO GL): “RR stands for the active power reserves available to restore or support the required level of Frequency Restoration Reserves to be prepared for additional system imbalances, including operating reserves” [9].

Thus, TERRE focuses on the use of balancing products with an activation time higher than 15mins, which is the required level to restore frequency in all TERRE participants.

Regarding the provisions set in Chapter 2 of the EB GL, Article 19 on European Platforms for the exchange of Balancing Energy: “TSOs using RR should establish a multilateral TSO-TSO model with common merit order list to share and exchange all balancing energy bids from all standard products for RR” [7].

In the previously mentioned QR EB, ACER proposed to apply these requirements by end 2019, as requested in NC EB [10]. Thus, the current situation of TERRE design could be summarised as follows:

- By end 2016, during the public consultation phase, this project was evaluated positively by European stakeholders and the National Regulatory Authorities;
- Currently, TERRE has launched the implementation phase under the so called Cooperation Agreement (CA) between involved TSOs. This phase includes the development of the platform (LIBRA) for gathering all RR products. In this phase is also included the local implementation by TERRE participants, the establishment of the governance process (rules and guidelines to operate the platform), harmonisation of RR products (national differences and settlement procedures) and the “go-live” of the project.

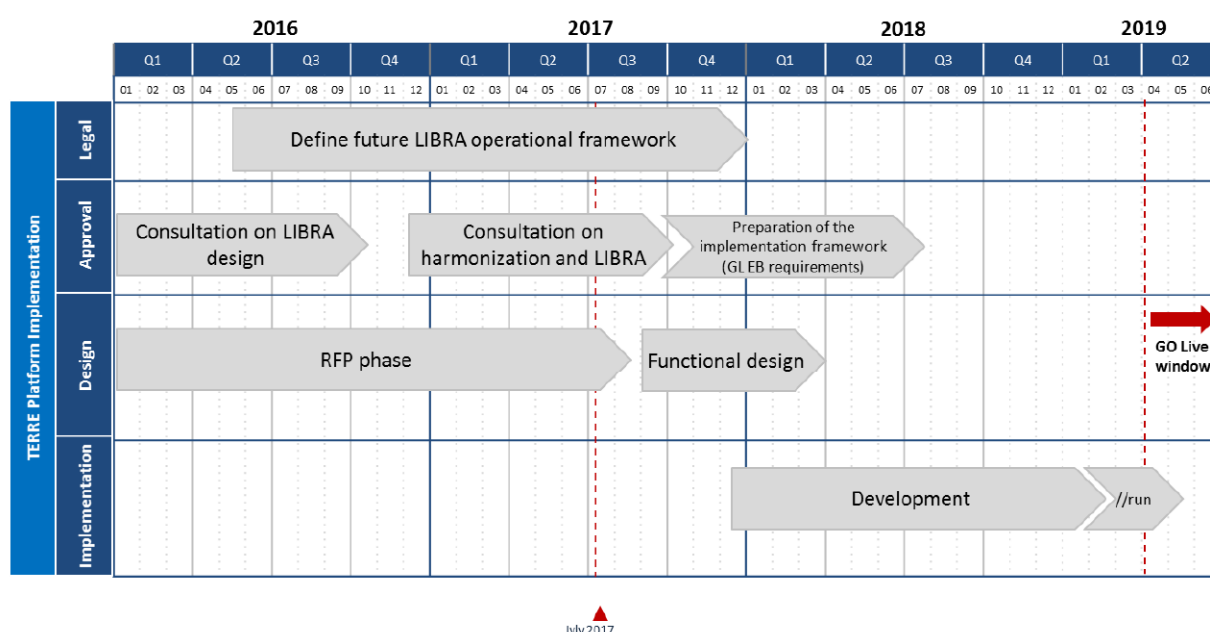
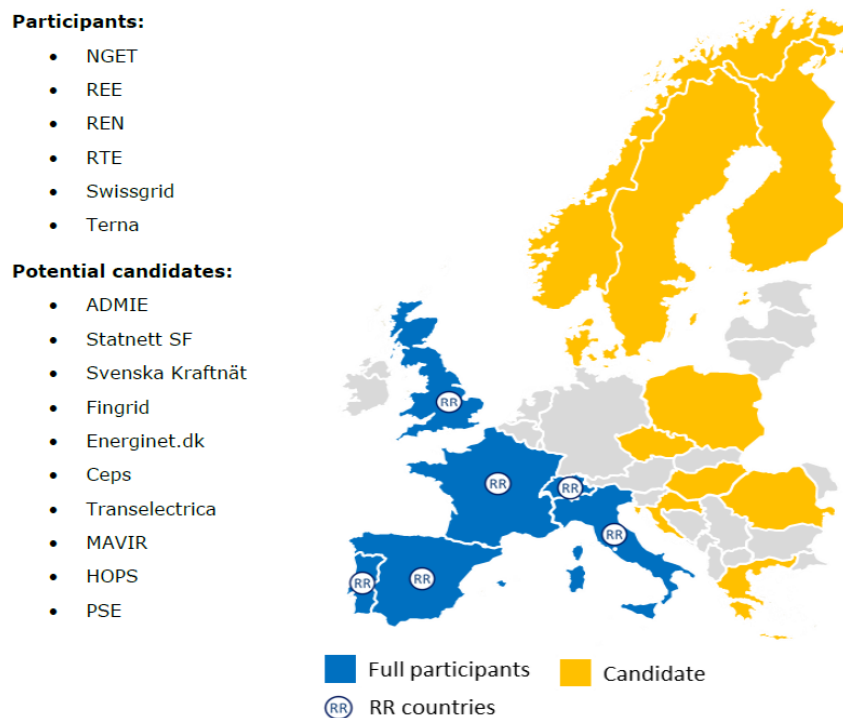

Figure 3: TERRE design phases

So far, the TERRE project gathers Transmission System Operators from Portugal (REN), Spain (REE), France (RTE), Italy (Terna), Switzerland (Swissgrid), and Great Britain (NG) as members, as well as TSOs from Ireland (EirGrid and SONI) as observers [11].

The *Figure* below also shows the list of potential candidates for the implementation of this project [10]:



*Figure 4: TERRE participants.*

*Source: Consultation paper on TERRE design. 2017*

Interrelationships between the TERRE project, the EB GL and the corresponding company's simulation tool LPRM-TERRE model are tackled in the core of the document.

## 2.3 TERRE main specifications

### 2.3.1 TERRE precursor

BALIT (Balancing Inter TSO) project is a bilateral solution for the exchange of balancing energy which has been widely used between NG-RTE, REE-RTW and REN-REE [11]. Therefore, it could be defined as TERRE precursor.

In a simplified way, BALIT scheme enable participating TSOs to exchange balancing energy as follows [12]:

- Each TSO keeps its own reserves and procurement mechanisms.

- Next to real time, if a TSO has unused balancing energy (surpluses), it bids it into a common platform, which collects TSO to TSO tenders, manages the allocation process and displays the results of each participating TSO.
- TSOs procure the reserves when needed or it is economically interesting for them.
- As exchanges are done next to real time, no reservation of interconnection capacity is needed (only the remaining the Available Transmission Capacities (ATC) are used).

BALIT model complies with the Project Coordination Group (PCG) mid-term target model with multilateral TSO to TSO mechanism [13]. However, the European Union needs to go one step further in the achievement of an integrated energy market and, in this case, in the harmonisation of balancing markets. This integration of balancing mechanisms must be geared with a structural change of national procurement mechanisms, the definition of a new cross border product or the developing of new algorithms so that the social welfare would be properly maximized. At this point comes the successor of BALIT, the TERRE project, which complies with the PCG Long Term Target Model in line with the Framework Guidelines and Network Code on Electricity Balancing.

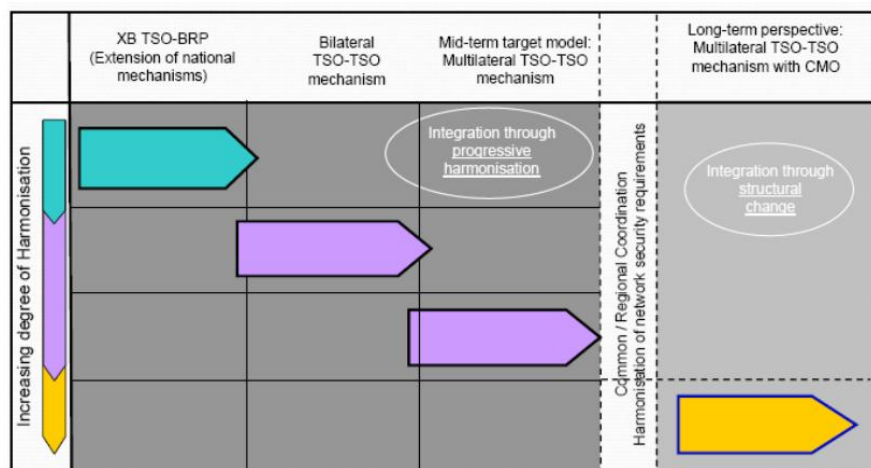

Figure 5: Proposal of the roadmap for the Integration of Balancing Markets.  
Source: PCR

The previously *Figure* shows the Project Coordination Group’s proposal for the integration of balancing markets for each timeframe.

### 2.3.2 TERRE design

TERRE is currently the leading early pilot project for the Replacement Reserves (RR) and it aims to implement a multilateral TSO-TSO coordinated exchange of RR Cross-Border Balancing Energy, being compliant with the guidelines and objectives of the Network Code on Electricity Balancing [14].

This project pursues to establish and operate a platform (known as LIBRA) [10] capable of gathering all the offers for RR from Transmission System Operators' local balancing markets by providing an optimized allocation of RR to cover TSOs imbalance needs.

At this point, the reader can find an important difference with respect to the BALIT project, since TERRE will gather not the balancing energy surpluses, but all the offers for RR.

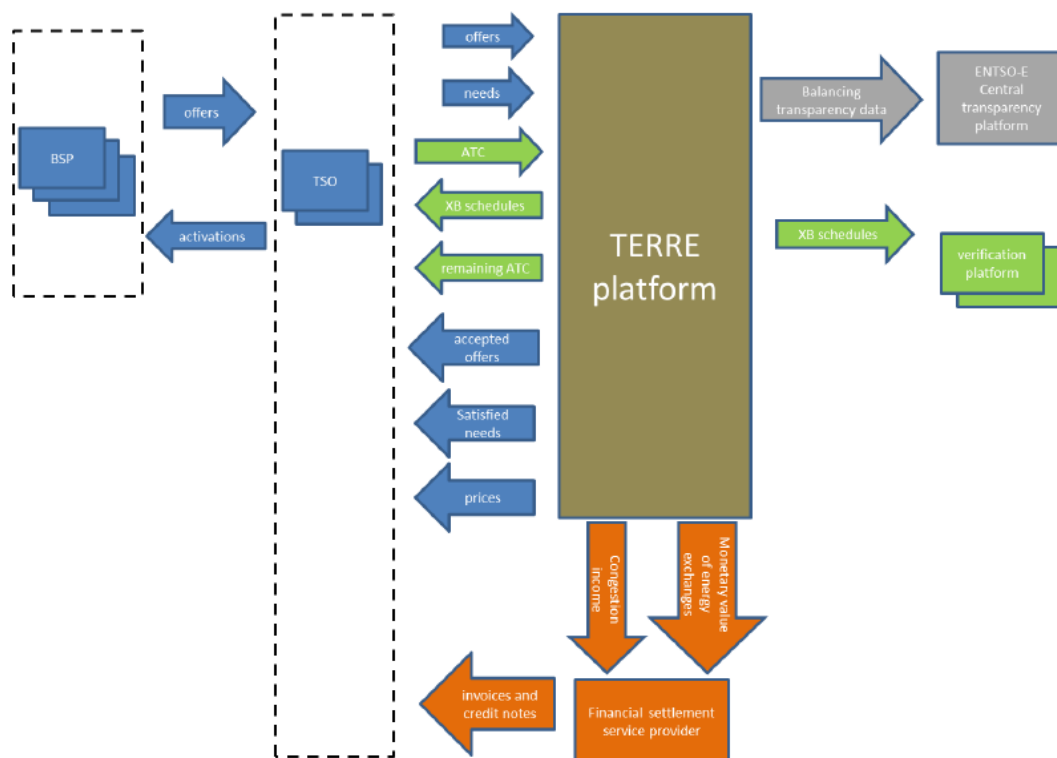

Figure 6: LIBRA platform flows

The expected benefits of the TERRE project include, but are not limited to:

- Integrating balancing markets and promoting possibilities for exchanges of balancing markets but taking into account high operational security.
- Enhancing the efficiency of balancing, not only at national level, but also at regional and, consequently, European level.
- Ensuring that the procurement of balancing services is fair, objective, transparent and market based. Thus, barriers to entry for new agents are avoided.
- Algorithmic optimization including automatic ATC management.
- Fostering the liquidity of balancing markets and avoiding distortions in the internal market of electricity.

- Facilitating the participation of demand respond services and intermittent generation, such as renewable energy sources.

As it can be observed, the majority of these points comply with the objectives of the current changing environment at European level.

### **Definition of the cross-border product**

Due to the differences concerning Replacement Reserves among each European country, TERRE project aims to create a standard product for RR. According to the Article 2, Definitions, in the NC on EB, a standard product is: *“Harmonised balancing product defined by all TSOs for the exchange of balancing services”* [7].

	Spain (RR and Mfrr)	Portugal (RR and Mfrr)	France (RR and Mfrr)	GB (RR and Mfrr)	Switzerland (RR and Mfrr)	Italy (RR and Mfrr)
Procurement Scheme	Organized market	Mandatory offers	Pre-contracted and mandatory offers	Pre-contracted and mandatory offers	Organized market	Mandatory Offers
Implicit or explicit balancing markets	Explicit	Explicit	Explicit and Implicit	Explicit and Implicit	Explicit	Explicit
Min bid size	0.1 MW	1 MW	10 MW	1 MW	5 MW	1 MW
Wind or solar participation	Regulation entered in force on February 2016	No	No	Yes	Yes	No
Settlement Rule	Marginal Pricing	Marginal Pricing	Pay As Bid	Pay As Bid	Pay As Bid	Pay As Bid
Dispatch method	Self	Self	Self	Self	Self	Central

Figure 7: Overview of different manual reserves balancing markets in TERRE participants.  
Source: Own development [11].

The above *Figure* summarises each country current balancing products. At this point, it is important to highlight that Replacement Reserves products are not such as implemented. In other words, there is not a clear differentiation of RR in TERRE involved countries. This must be taken into account with respect to data used in the model; since input data could change once the standardisation of European RR products would be implemented.

### **TERRE product**

The TERRE basic product is a 15min scheduled block, which can be activated for fixed quarter hours or a multiple of a fixed quarter hour. However, product full activation time is 30 minutes – see process below. Transmission System Operators are in charge of physically schedule this block and setting block energies among them. .

Standard Characteristics	
(0) Activation Principle	Scheduled
(1) Preparation Method	From 0 to 30 min
(2) Ramping Period	From 0 to 30 min
(3) Full activation time	30 min
(4) Minimum quantity	1 MW
(5) Minimum delivery period	15 min
(6) Maximum delivery period	60 min
(7) Location	Bidding zones
(8) Validity period	Defined by BSP but equal or less than 60 min
(9) Recovery Period	Defined by BSP
(10) Maximum Offer size	In case of divisible offer, no max is requested. In case of indivisible offer, local rules will be implemented
(11) Divisible volume	Under responsibility of BSP
(12) Price	Local rules for cap/floor will be implemented if no harmonization
(13) Time resolution	15 min

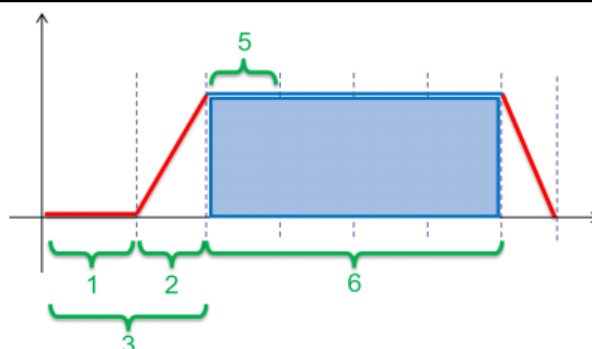

Figure 8: TERRE basic product standard characteristics

Annex A shows a clear comparison among TERRE product and local RR products under the current situation.

### **Format of balancing offers**

The format of balancing offers is a critical element of the TERRE project. According to TERRE specifications, the following formats can be utilised by the common merit order:

- Divisible Offers.
- Block Offers.
- Exclusive Offers.
- Multi-part Offers.
- Linking Offers.

Without entering into further detail concerning the explanation of such formats, it is important to highlight that, in accordance to the European Federation of Energy Traders (EFET), stakeholder's preferences focus on the implementation of formats that are common to all markets (i.e. block offers) [15]. Although there could be some benefits in the implementation of more complex formats (i.e. multi-part offers), these are not common to all markets affecting thus the complexity of the TERRE algorithm and, consequently, market participants. The format of bids used in the algorithm is explained in next sections.

## Imbalance need definition and elasticity

The ground-breaking initiative of TERRE project is that Transmission System Operators may act as market agents. In other words, in the same way as agents' offers, TSO's imbalance needs have several characteristics.

Imbalance Need Characteristics	
<b>Anticipation Time</b>	Scheduled
<b>Minimum Size</b>	0 MW
<b>Minimum delivery period</b>	15 min
<b>Maximum delivery period</b>	60 min
<b>Location</b>	Bidding zones
<b>Maximum Size</b>	The maximum size of the Imbalance Need should be less or equal to the sum of the shared offers made in the same direction. Under certain conditions. A TSO can notify the system which will apply and exception to this rule
<b>Divisible Volume</b>	Under the responsibility of TSO to a resolution of 1 MW
<b>Price</b>	For <b>inelastic needs</b> TSOs will not price their needs. For <b>elastic needs</b> a price will be submitted, which will set a min/max price each TSO is willing to receive/pay to satisfy its needs
<b>Time Resolution</b>	15 min
<b>Firmness</b>	Yes
<b>Direction</b>	<b>Positive</b> (system short); <b>Negative</b> (system long)

*Figure 9: TSOs imbalance needs characteristics*

Taking into account the purpose of this Master's Thesis, this document will only focus on pricing TSO's imbalance needs:

- An inelastic volume will be defined as an "at all price" need –instrumental prices. In other words, this volume of imbalance needs represents the need that the TSO would certainly want to cover.
- An elastic volume will be defined as a "priced" need. In other words, this is a couple of volume/price or a set of them, which only constitute part of the TSO's needs. The objective of this elasticity is that it could help the TSO to deal with uncertainties when defining its imbalance volumes.

By submitting many couple of volume/price as TSOs want, they could deal with imbalance uncertainties and expressing its alternatives for unexpected imbalances near to real time. An elastic need would help the TSO to try to satisfy the need in an efficient way, while keeping faster available resources - mFRR, aFRR or local products.

In any case, the TSOs must be transparent and, for this reason, each TSO will have to define the applicable methodology for determining their volumes.



To sum up, according to the Public Consultation 23<sup>rd</sup> June 2016: *“The simple objective of allowing elastic need is to allow the TSOs to co-optimize across all the resources at their disposal with the aim of balancing the system at the lowest expected cost”*. [15]

In section 3.3.2, the reader will find the methodology applied for the determination of each TSO strategy when pricing its imbalances and, finally the results obtained as a consequence of the implementation of this new elasticity scenario.

### **Balancing Common Merit Order (CMO) and algorithm**

The main objective of the TERRE algorithm is the maximization of the social welfare, since it enhances the efficiency of the market. As previously stated, the clearing process could take into account the use of elastic imbalance needs, which will provide flexibility to TSOs for deciding which alternative they want to use. In other words, TSOs could decide if they want to use the TERRE platform or an alternative possibility such as RR local markets. Hence, balancing costs will be reduced which, at the end, will be reflected in the costs that businesses and consumers have to bear on with.

On the other hand, this possibility allows the simplification of the netting process, since netting will be implemented based on the submitted imbalance needs in the one-stage clearing process and no in predefined rules (i.e. proportional distribution among systems).

The reader must take into account that imbalances can remain inelastic if TSOs decide it (i.e. by setting a maximum instrumental price).

These two cases will be particularly treated in the programming of the new long-term forecasting tool

### **One single CMO and one-stage clearing process**

The main benefit of applying one CMO is that it allows the counter-netting of imbalance needs in one-stage process, maximizing social welfare while ensuring an efficient allocation of available transmission capacities (ATCs).

If there exists two CMOs (one for positive imbalance needs bids/upward offers and one for negative imbalance needs/downward offers), netting would only be possible if imbalances are pre-netted before the clearing process, affecting thus the social welfare.

On the other hand, the balancing CMO also calculates the TERRE clearing price, which would result in the marginal price for the TSO-TSO clearing.

Although there are two possible schemes for the settlement of the RR energy exchange through this European platform (pay as bid or pay as cleared (marginal)), the preferred option in the FG and NC EB (2017) is the application of marginal pricing schemes. In accordance to Article 30 of NC EB: *“Pricing for balancing energy and cross-zonal capacity used for exchange of balancing energy or for operating the imbalance netting process. By one year after the entry into force of this Regulation, all TSOs shall develop a proposal for a methodology to determine prices for the balancing energy that results EN 38 EN from the activation of balancing energy bids for the frequency restoration process pursuant to Articles 143 and 147 of Commission Regulation (EU) 2017/000 [SO], and the reserve replacement process pursuant to Articles 144 and 148 of Commission Regulation (EU) 2017/000 [SO]. Such methodology shall be based on marginal pricing (pay-as-cleared);”* [7].

The figure below shows a simplified scheme of the aforementioned clearing process and CMO.

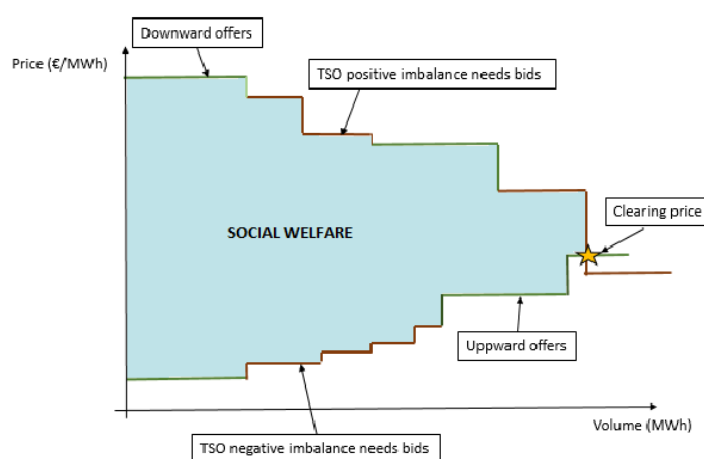

Figure 10: Simplified scheme for one CMO and one-stage clearing process.  
Source: Own development

One can observe, the selling curve will be formed by the upward offers and downward needs and, the buying curve will be formed by the downward offers and upward needs.

Regarding the calculation of the marginal price, the following consideration must be taken into account:

- A set of non-congested bidding zones have the same marginal price. In other words, there is not market splitting among country participants so the resulting marginal price is the same among them.
- In case of congestion on one border, there could be different prices at both sides of the interconnection.

As a curiosity, there is a single price for each bidding zone, as downward/upward offers as well as TSOs' needs are jointly treated; hence, there is no separate price for downward and upward activations.

Finally, taking into account the standardization of the RR products – 15min basis–, there will be a marginal price every 15 min or even more in case of technical restrictions/congestions in the network.

In section 4.5, the reader will find the comparison among the results obtained in the two type of clearing processes.

### Netting method

Netting is the action of matching two imbalance needs of opposite directions. If upward imbalances are netted with downward imbalances –or vice versa–, fewer imbalances remain so that fewer offers have to be activated.

This section will be particularly treated in section 3.5., where we will differentiate the effects of pre-netting versus implicitly netting in the one-stage clearing process.

### Congestions

When congestion occurs –when the existing ATC is not able to carry out the cheapest transactions– among TERRE participants, the results obtained in the clearing process might be suboptimal, for example, by reducing the social welfare.

Impact of congestions would result in the use of more expensive offers or may have an impact on netting, for example, by avoiding the netting of two imbalance needs and, therefore, TSOs would have to activate balancing energy offers.

### Congestion rents

When congestion takes place, different marginal prices appear at both sides of the border.

As a consequence of the price difference between the price that an area is “willing to pay” and the price that the other area is “willing to receive”, a surplus takes places. This surplus, is calculated as the cross-border schedule across the interconnection –exchanged balancing energy– times the difference in energy prices:

$$\text{Congestion Rent} = (\text{Cross – border Schedule}) \cdot \Delta P$$

It is important to highlight that the distribution of these congestion rents is a regulatory issue that should be established from the NRAs.

This section will not be covered in this document, since it falls out of the scope of this thesis.

### Timing

As well as in day-ahead or intraday markets, TERRE phases are carried out between the opening and the closure of the corresponding gate.

TERRE processes will begin one hour before the product delivery period, and Balancing Services Providers (BSPs) will be notified of activation of their bids 30 minutes before the TERRE product delivery period. The 30 minutes at the start of the process named “TERRE Process” is an important timeframe, and in the first 15 minutes TSOs will have to carry out several tasks in order to be ready to submit data to the central platform and allow the TERRE algorithm to communicate final results 30 minutes before real-time.

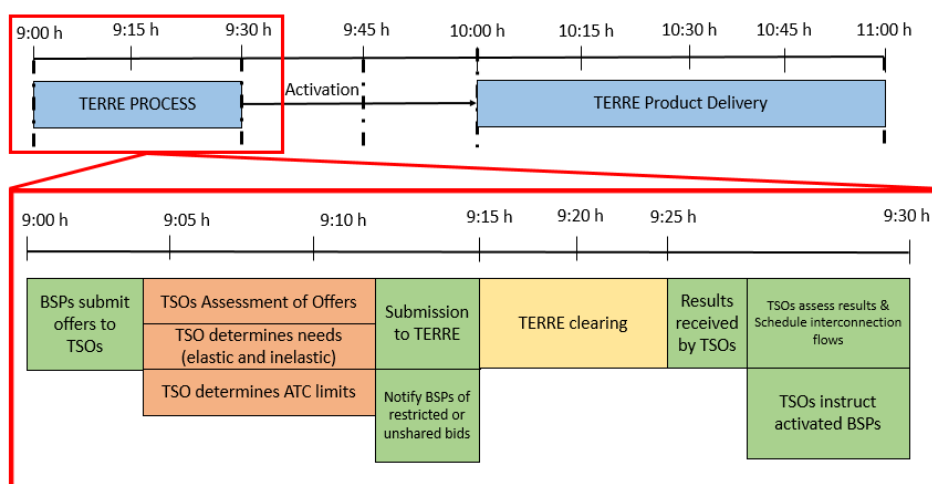

*Figure 11: TERRE process timeline.  
Source: Own development. National Grid data.*

Furthermore, two important aspects within this TERRE process timeline:

- At the TERRE Balancing Energy Gate Closure Time (BEGCT) Balancing Services Providers (BSPs) can no longer update their TERRE product offers. After this point submissions become firm.
- Transmission System Operators assess offers in order to ensure operational feasibility.

### Fall-back process

If the TERRE clearing process fails, participants would procure and activate balancing energy only at national level

## 2.4 Future Projects. MARI-Project

Given the expected similar approach of this project with respect to TERRE project, we consider that it is important to mention the key points of this recently defined pilot project, MARI-Project.

On 5th April 2017, nineteen European Transmission System Operators signed a Memorandum of Understanding (MoU) for establishing common guiding principles with the aim of integrating European Manually Frequency Restoration Reserves (mFRR) within the multilateral TSO-TSO principle [15]. This project, known as Manually Activated Reserves Initiative (MARI) is focused on the achievement of the following issues:

- Maximizing social welfare;
- Facilitating netting of TSO mFRR needs;
- Optimizing the allocation of cross-zonal capacities given to MARI one-single platform;
- Final settlement based on marginal prices (NC EB).



*Figure 12: MARI-Project participants  
Source: Svenska Kraftnät*

This project is expected to optimistically entry into force in 2022 complying thus with the foreseen timescales within the regulatory framework.

### 3. LPRM-TERRE Model

Before starting main aspects of LPRM-TERRE Model, some considerations must be taken into account:

- LPRM-TERRE Model could be defined as a hybrid model, given that it combines econometric (i.e. competition patterns and imbalances) and fundamental models (i.e. available resources).
- In the previous section, the reader could find all Member States involved in TERRE pilot project. However, considering the purpose of this document and the aim of mainly focusing on Endesa's results, this simulation tool has only taken into account Portugal, Spain and France –which represents an approximation of the rest of Europe–, as TERRE participants. However, this simplification makes sense, given that Endesa only has European generation units in Spain and Portugal.
- Hypothesis concerning French competition patterns and Transmission System Operators have been taken.
- This model will not consider the TERRE basic product -15min scheduled blocks-, but hourly products. The explanation of this fact is that, in Spain and Portugal scheduling is hourly and it is not expected to change in the short-term.

From this point forward, this section will focus on the main characteristics of the initial design of this model and the implemented changes in order to comply, as far as possible, with the EU requirements and TERRE Project specifications.

#### 3.1 Endesa's long-term forecasting tools.

Prior to the explanation of the LPRM-TERRE Model algorithms, it is necessary to briefly introduce the different long-term forecasting tools the company already has, since most of them are used as input data.

These models follow a temporal sequence, which coincides with the temporal sequence of the operational markets managed by the Spanish Transmission System Operator, Red Eléctrica de España (REE). The *Figure* below represents schematically the just mentioned sequence of models.



Figure 13: Company's forecasting tools.

Taking into account that the new model is designed so that it replaces the existing tool for tertiary reserves and deviations management, the so called *Largo Plazo Resto Mercados (LPRM) Model*, the author in charge of the initial design of the TERRE simulation tool decided to call it using the same acronym but adding at its end the name of the pilot project under study. Following this decision, the new forecasting tool will be called with the same acronym.

## 3.2 Input data

### 3.2.1 Competition patterns

The behaviour of competitors is usually determined through deeply studies based on clustering techniques. Hence, a big number of hourly bidding curves re gathered together in accordance to a certain tolerance which determine similarity among them.

In the initial LPRM-model, input data concerning competition patterns was determined through a set of four curves resulting from the application of the previously mentioned techniques. These curves were driven by the variation of the bid price with respect to the day-ahead market prices and the percentage of market shares. However, during the development of the new forecasting tool, we realised that this methodology was not appropriate in this particular case. Thus, competition patterns are now analysed with curves driven by the variation of the bid price with respect to the day-ahead market prices and normalized competitors' imbalances.

Regarding competitors' behaviour in Spain and Portugal, clustering is applied since offers historical data -curves- are available. However, there is not data for French patterns. For this reason, it has been necessary to think up a new methodology for the determination of French offers.

Considering that the only available data concerning French offers are market cleared volumes/prices, we have decided to establish an explicative variable in such a way that way that we are able to gather all the data that present certain similarities. In this case, we have decided to apply an explicative variable<sup>4</sup> related to the demand in the French system.

---

<sup>4</sup> Additional explicative variables (i.e. hydro generation vs. high demand levels) can be applied so that a higher level of accuracy in final results can be achieved.

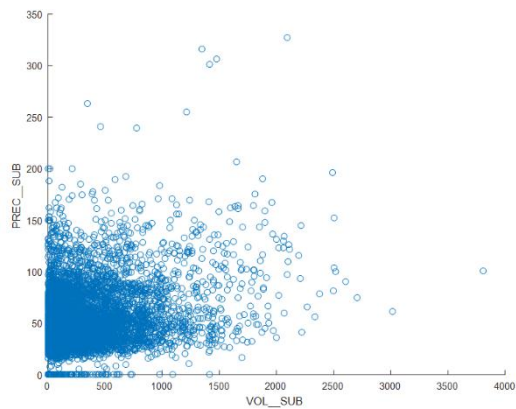

Figure 15: French system cleared prices/volumes

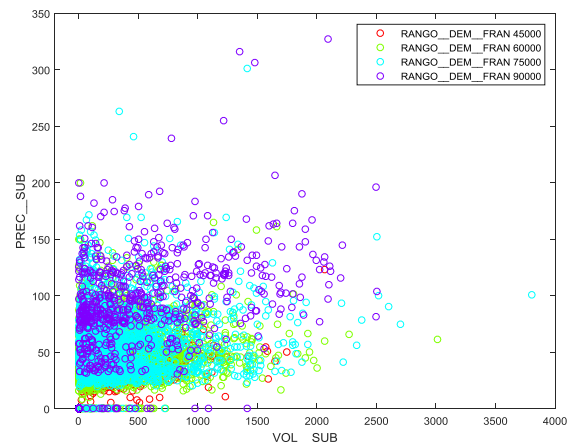

Figure 14: Cleared points after applying an explicative variable

For doing that, we have used a model designed by the Instituto de Investigación Tecnológica (IIT) at Universidad Pontificia de Comillas, which is able to differentiate the cleared points depending on the level of demand –high versus low demand scenarios. After that, the model clusters similar points allowing thus the determination of the competition patterns.

### 3.2.2 Available resources

These are defined as the units resources that have not been used in previous markets (i.e. day-ahead market) so that the remaining capacity could still be used. Although the programming of these routines is out of the scope of this Master's Thesis, it is important to briefly mention the data that LPRM-TERRE model imports from previous forecasting tools:

- Data from the Secondary Reserve Market is imported from the so called *Largo Plazo Banda* (LPB).
- Data from technical restrictions and intraday-sessions are also imported.

## 3.3 Upward/Downward curves

### 3.3.1 Bids format

According to TERRE specifications, the common merit order can be utilised with different formats of bids –block offers, multi-linked offers...–, however, taking into account the purpose of this Master's Thesis and the simplifications that must be implemented, LPRM-TERRE model processes simple offers. Maintaining the previous format, bids are defined with the name of the origin of the offers and a set of volumes and prices.



Regarding the origin, it is important to clearly differentiate among countries, Endesa's units and competition patterns.

Origin	Energy (MW)	Price (€/MWh)
FR S3	16	32
ES EN LIT1	28	41
PT S2	16	46
ES S1	21	42

Figure 16: Bids format in LPRM-Model

### Endesa's bids

The calculation of Endesa's bids follow the same procedure as in the previous LPRM-TERRE model. These are based on units' hourly available resources, the associated variable costs, an increment of price and a defined strategy.

### Competitors' bids

As stated in the subsection 3.2.1, competition behaviour is forecasted based on certain patterns. Since competition patterns have been modified and previous curves –calculated as the price increment with respect to day-ahead market prices and percentages hourly imbalances– are no longer applicable, it has been necessary the introduction of certain modifications in the algorithm. Whereas price increment formulation is maintained, energy offers are directly calculated with normalized imbalances patterns (MWh). Thus, we are not longer dealing with percentage of imbalance needs

$$\text{Offer Price} \left( \frac{\text{€}}{\text{MWh}} \right) = \Delta P(\%) \cdot \text{DAP}^5 \left( \frac{\text{€}}{\text{MWh}} \right)$$

$$\text{Offer Energy (MWh)} = \text{Pattern Imbalance Need (MWh)}$$

### 3.3.2 Imbalances curves. Transmission System Operators' priced imbalances

The ground-breaking initiative of TERRE project is that TSOs may act as market agents by establishing prices to their upward/downward imbalances. By doing that, TSOs are willing to cover all or only a portion of their imbalances.

<sup>5</sup> DAP stands for day-ahead prices.

## TSOs strategies

Considering that there is not historical data regarding TSOs priced imbalances, certain hypothesis must be considered.

In this case, the author has designed an alleged strategy for building upward/downward imbalances curves. Regarding upward needs, the strategy is divided in: 1) a very high price – instrumental price or “price taker” –, which corresponds to the portion of imbalances that each TSO wants to certainly cover; 2) medium price –probable cleared price– and; 3) very low price – improbable cleared price. On the other hand, the strategy of downward needs is divided in: 1) a very low price –“at all price”–, which again corresponds to the percentage of imbalances that will be surely covered; 2) medium price –probable cleared price– and; 3) very high price –improbable cleared price.

		TSOs Strategies					
		UPWARDS STRATEGIES			DOWNWARDS STRATEGIES		
		REN	REE	RTE	REN	REE	RTE
PRICE TAKER	Imb(%)	0.33	0.33	0.33	0.33	0.33	0.33
	Price	180	180	300	0	0	0
PROBABLE CLEARING	Imb(%)	0.33	0.33	0.33	0.33	0.33	0.33
	Price	1.6*DAP	1.6*DAP	1.6*DAP	0.1*DAP	0.1*DAP	0.1*DAP
IMPROBABLE CLEARING	Imb(%)	0.33	0.33	0.33	0.33	0.33	0.33
	Price	0.9*DAP	0.9*DAP	0.9*DAP	1.3*DAP	1.3*DAP	1.3*DAP

Figure 17: TSOs pricing imbalances. Strategies

The above *Figure* shows the strategy used in the development of the new forecasting tool. Taking into account that there is not current data regarding the strategies each TSO will use, we have decided to use a strategy in which the TSOs only want to surely cover one-third of total downward/upward imbalances.

Although one may think that this strategy is improbable, the answer is that we do not really know how this strategy is going to be. Hence, have decided to check the effect of this situation in order to show how this affect final results.

### 3.4 Determination of cross-border capacity

Benefits from TERRE implementation are highly dependent on the availability of interconnections.

Since interconnections among countries may be congested, some countries may not be benefited from the integration of balancing markets –expensive resources are needed to satisfy their imbalances. Thus, the main consequence of unavailable interconnections is the reduction of the social welfare –*Figures 28 and 29* represent in a simplified way this reduction.

Taking into account that there is not historical data regarding cross-border capacity in real-time markets, certain assumptions were performed in the previous forecasting tool. Down below, the reader can find the applied methodology:

- Commercial capacity is imported from previous forecasting tools;
- Comparison of day-ahead market prices among countries;
- When two neighbouring countries possess different day-ahead market prices is due to the fact that interconnections have been congested so that cross-border trade is not possible at that specified time.
  - The country with a higher market price was the one that was importing energy sources and, consequently, the importing capacity is congested.
  - The exporting capacity would be calculated as the sum of the importing hourly commercial capacity and the exporting hourly commercial capacity.
- If two neighbouring countries possess equal day-ahead market prices, it is assumed that the available capacity is half of the importing/exporting commercial capacities, respectively.

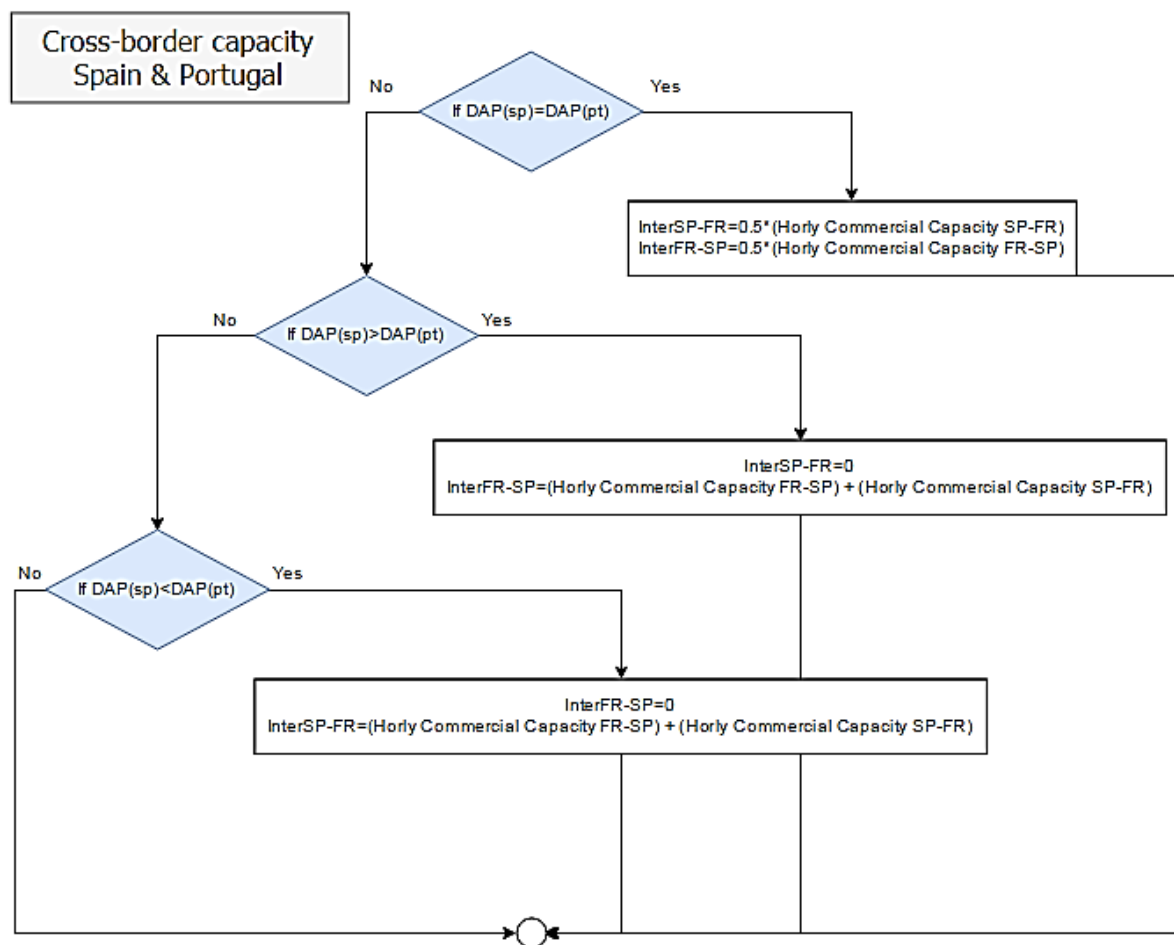

Figure 18: Flowchart for the determination of cross-border capacity

The above *Figure* shows the flow chart concerning the calculation of cross-border capacity among Spain and Portugal. The reader must notice that the procedure for the calculation of cross-border capacity among Spain and France would be the same, but taking into account the pertinent day-ahead market prices.

### 3.5 Netting method of Imbalance Needs

Netting is the process of matching two imbalance needs of opposite directions, for example, by transferring energy from a zone that has a negative imbalance need to a zone with a positive imbalance need and vice versa.

When netting occurs, fewer imbalances remain, and consequently, fewer offers have to be activated. However, according to the public ENTSO-E consultations, fewer activated offers do not necessarily result in lower marginal prices or higher social welfare. The reasoning for this statement is that, in some cases, the activation for downward/upward offers might be financially more beneficial –and higher social welfare– compared to netting imbalances.

According to TERRE specifications, the unique common merit order (CMO) and the one-stage clearing process, allows netting imbalance needs implicitly. In other words, there is no differentiation between the netting of imbalance needs and the activation of generators bids.

Thus, it is said that a higher social welfare is achieved when compared to pre-netting of imbalance needs in both, one-stage and two-stage clearing processes. Again, we have decided to follow both methodologies in order to compare final results.

#### 3.5.1 Pre-netting of Imbalance Needs. Explicitly netting

Current LPRM-TERRE model enables users the possibility of choosing the pre-netting of imbalance needs. When the countries considered have imbalances with opposite directions (i.e. Portugal has upward imbalance needs and Spain downward imbalance needs) and the interconnection is available, it is possible netting both imbalances.



Figure 19: Example of the netting process

The above *Figure* shows in a very simplified way the concept of netting. The reader must take into account that electricity always flows from those places where there is an excess of generation - downward imbalances- to those where there is a necessity to increase generation -upward imbalances.

The applied criteria for carrying out the pre-netting of imbalances is the following one:

- Imbalances between Spain and Portugal are initially compared. If netting is possible –opposite directions and available interconnection capacity–, new imbalances are calculated.
- Netted imbalances between Spain and Portugal are compared with those in France. If netting is possible, new imbalances –lower or zero- remain in the considered systems.
- If netting was not possible between Spain and Portugal, the comparison is carried out among Spain and France.
- Usage of interconnections due to netting imbalances must be clearly defined.

ORIGINAL IMBALANCES (MW)						INTERCONNECTIONS CAPACITIES (MW)				PRE-NETTING POSSIBILITY	
PORTUGAL		SPAIN		FRANCE		SP-PT	PT-ES	SP-FR	FR-S	ES-PT	ES-PT-FR
UPWARD	DOWNWARD	UPWARD	DOWNWARD	UPWARD	DOWNWARD						
427	0	0	-814	0	-489	1173	1927	5700	0	YES	NO
230	0	0	-714	0	-538	1370	1730	5700	0	YES	NO
109	0	0	-967	0	-621	1491	1609	5700	0	YES	NO
0	-125	0	0	0	-951	1600	1500	5700	0	NO	NO
0	-176	3104	0	0	-633	1776	1324	633	5067	YES	YES
0	-109	0	0	0	-563	1600	1500	5700	0	NO	NO
134	0	0	0	414	0	1600	1500	5700	0	NO	NO
122	0	0	0	0	-420	1600	1500	5700	0	NO	NO
0	-155	0	0	0	-739	1600	1500	5700	0	NO	NO
0	-204	498	0	0	-802	1804	1296	5700	0	YES	NO

COMPENSATED IMBALANCES (MW)						NETTING DIFFERENCE (MW)					
PORTUGAL		SPAIN		FRANCE		PORTUGAL		SPAIN		FRANCE	
UPWARD	DOWNWARD	UPWARD	DOWNWARD	UPWARD	DOWNWARD	UPWARD	DOWNWARD	UPWARD	DOWNWARD	UPWARD	DOWNWARD
0			-386	0	-489	-427				427	
0			-483	0	-538	-230				230	
0			-858	0	-621	-109				109	
0	-125		0	0	-951						
		2295			0		176	-809			633
0	-109	0	0	0	-563						
134	0	0	0	414	0						
122	0	0	0	0	-420						
0	-155	0	0	0	-739						
0	0	294		0	-802	204		-204			

Figure 20: Forecasting tool interface. Netting results

The above *Figure* numerically shows the effect of pre-netting with respect to the original imbalances. Imbalances compensation, the usage of interconnections and netting differentiation must be clearly defined in order to carry out the analysis of results.

### 3.5.2. Implicitly netting

By using the one-single common merit order and one-stage clearing process, implicitly netting is possible. Since TERRE platform will gather downward/upward imbalance needs with upward/downward offers, netting process will be jointly calculated in the clearing process.

Hence, one can assume that the clearing process becomes more complicated than in the previous case.

The main benefit of implicitly netting system imbalances is that, social welfare is maximized Taking into account the definition of social welfare<sup>6</sup> – the confined area between demand and supply curves–, one can observe that by pre-netting imbalances, the area gets lower affecting thus the maximum social welfare

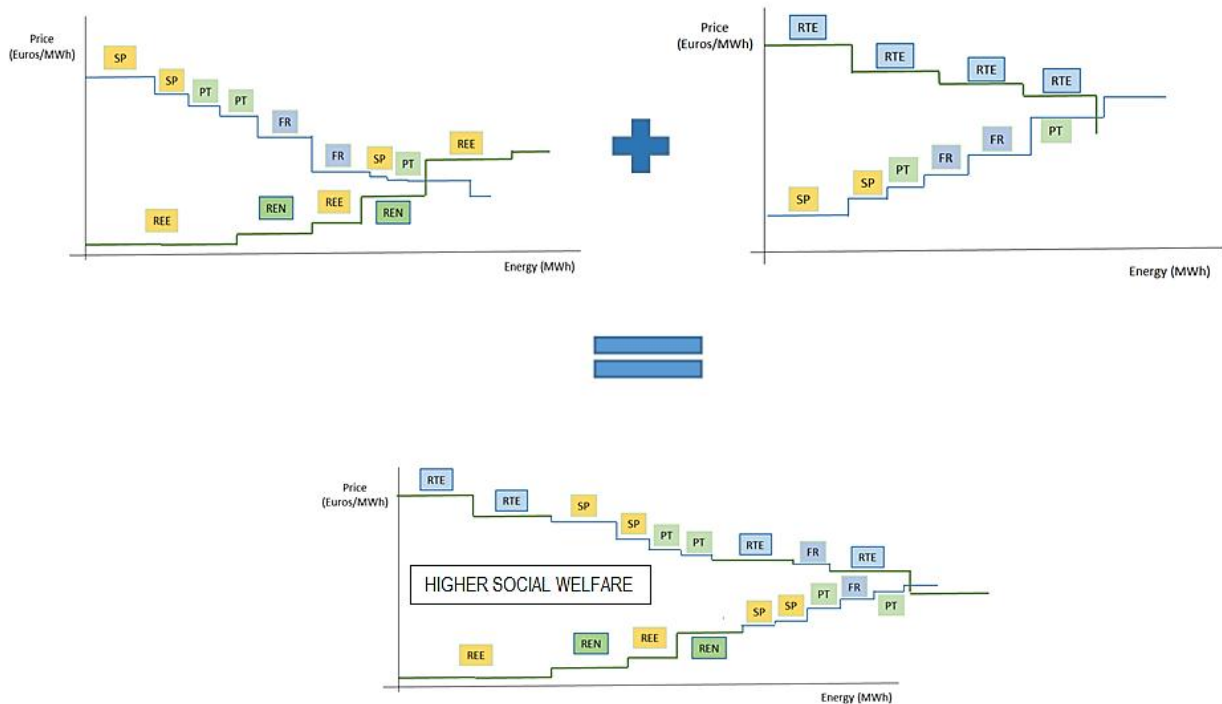

Figure 21: Aggregation of upward/downward curves

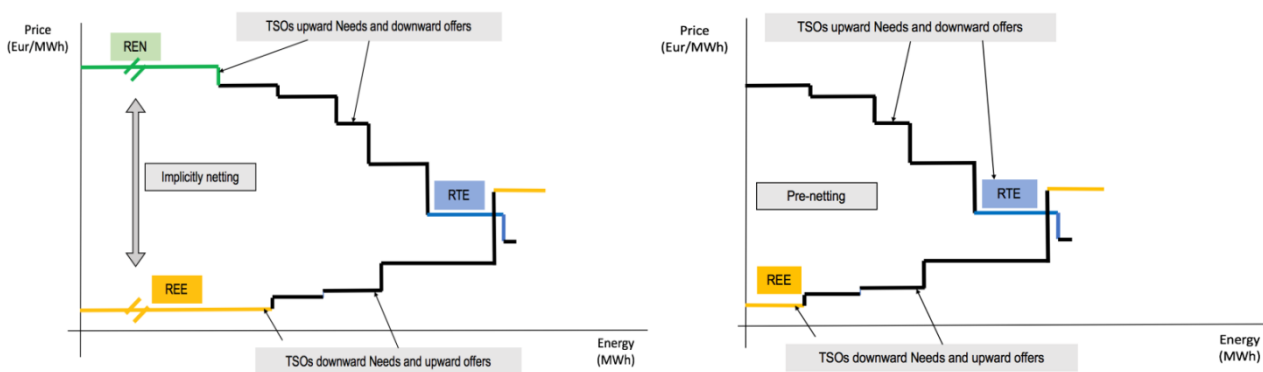

Figure 22: Comparison among implicitly netting vs. pre-netting. Effect on social welfare

The programming of this new methodology is explained in the next section

<sup>6</sup> TERRE project defines social welfare as the surplus of connecting TSOs, minus BSPs' production costs.

Netting of imbalances between Spain and Portugal

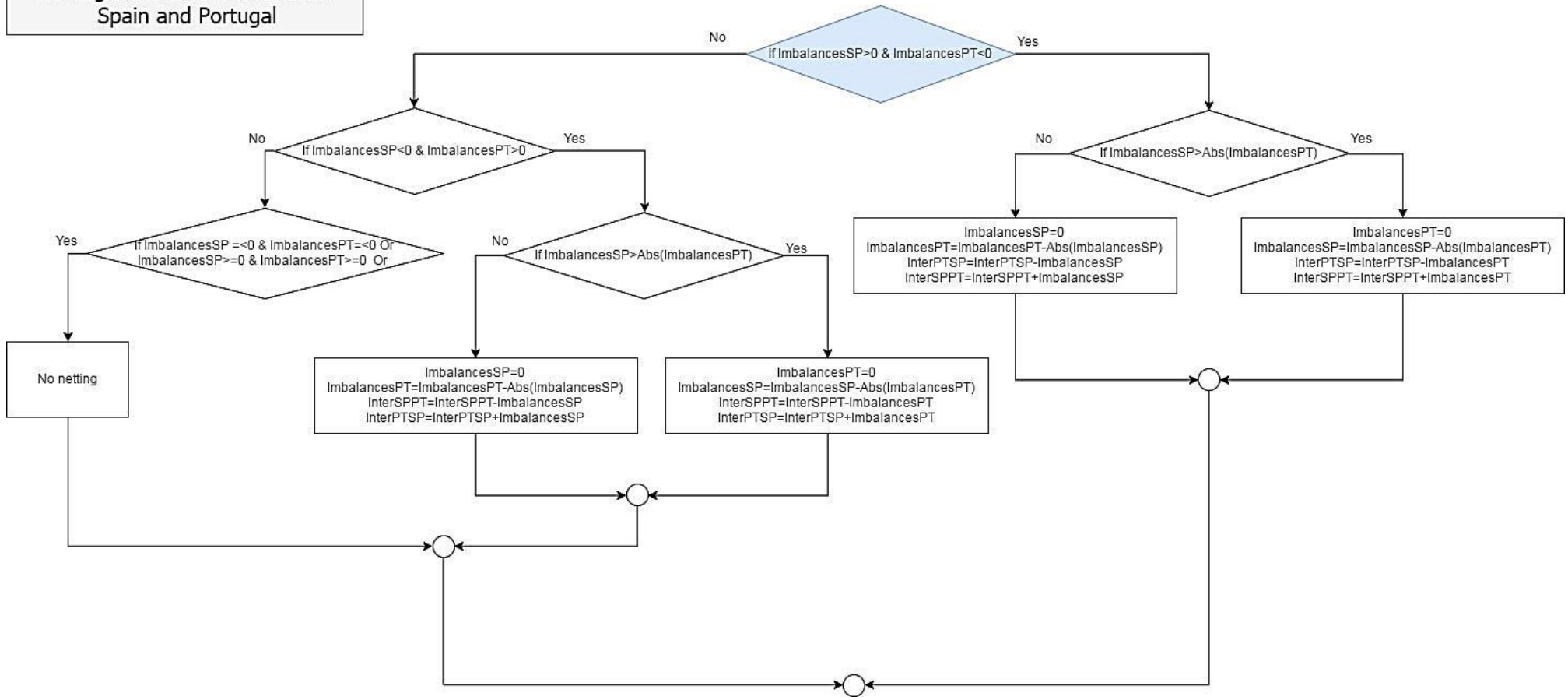

Figure 23: Flowchart for pre-netting imbalances

### 3.6 Clearing process

As explained in section 2.3.2, TERRE project stands for one single common merit order (CMO) and one-stage clearing process, combining thus priced upward/downward imbalance needs with upward/downward offers. At this point, it is important to highlight the difference between the previous design and the new one. Whereas the initial forecasting tool considered that all imbalances would be covered –same as inelastic volumes–, the new design considers the TSOs elasticities regarding imbalances. Although TERRE specifications emphasise the advantages of using one-stage clearing processes, we have decided to previously follow the two-stage one. This way, the reader could compare the advantages and drawbacks of using the three methodologies: 1) two-stage clearing process with inelastic volumes (initial design); 2) two-stage clearing process with elastic TSOs needs; 3) one-stage clearing process.

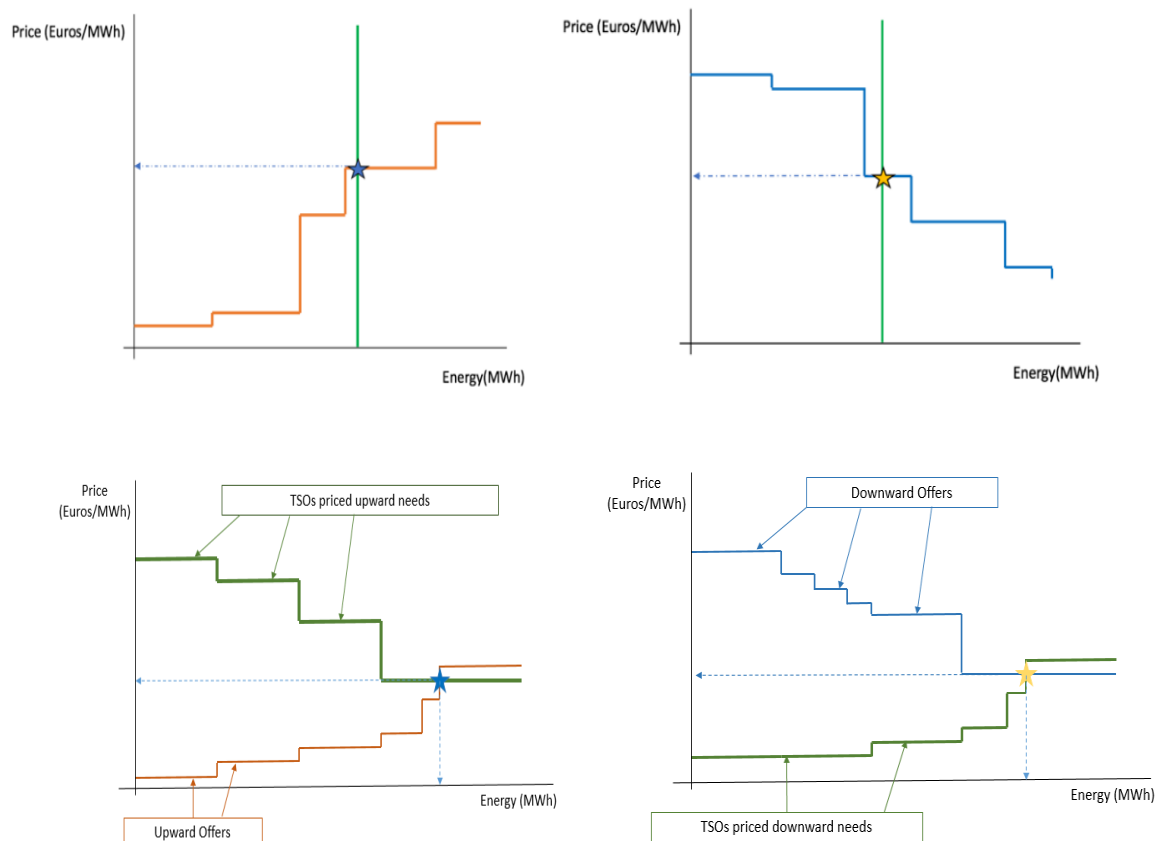

Figure 24: Comparison of original clearing process vs. two-stage clearing process

#### 3.6.1 Market Clearing Algorithm. Two-stage clearing process

This clearing process is structured in different subroutines:



- Firstly, cross-border capacities considered as infinite. In other words, there are not restrictions in the exchange of balancing products among market participants. Results from this stage provide the initial criteria for starting the clearing process but taking into account interconnections availability. In addition, results from this subroutine allow the user to compare the resulting market prices –single marginal price for all countries– with the ones obtained with the available interconnections. In this case, social welfare is maximized.

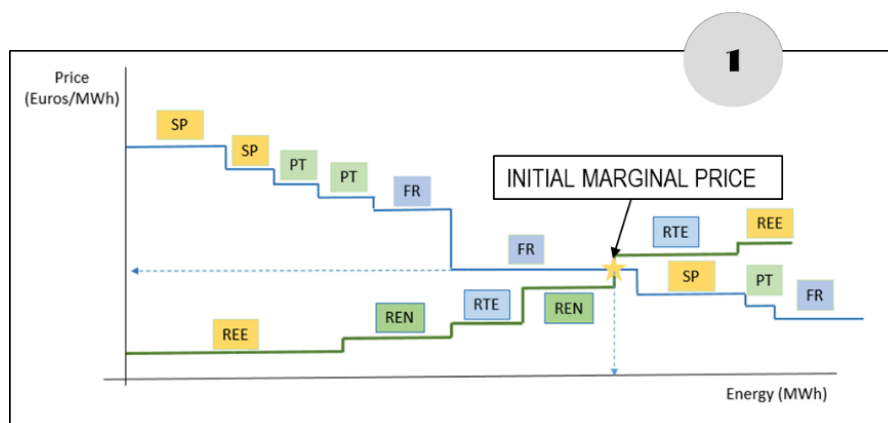

Figure 25: Two-stage clearing process ideal solution

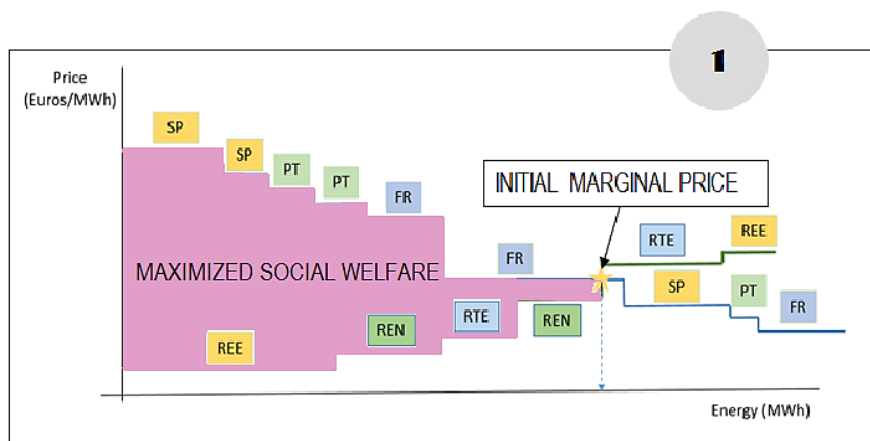

Figure 26: Maximized social welfare in the two-stage clearing process

- In the second subroutine, interconnections among countries are considered. The way of doing it is by checking the origin of offers from service providers with the origin of imbalances (TSOs offers). Since cross-border capacities are used as a consequence of energy flowing within the involved systems, the usage capacities (difference between the initial commercial capacities and final results) should be clearly defined.
- Since interconnections may be unavailable, initially cleared results (with infinite interconnections) would change.

At this point, a third subroutine would consider all initial non-cleared offers that may be needed if initial resources are not able to cover TSOs imbalances. At this point it is important to compared bids prices with priced imbalances from TSOs.

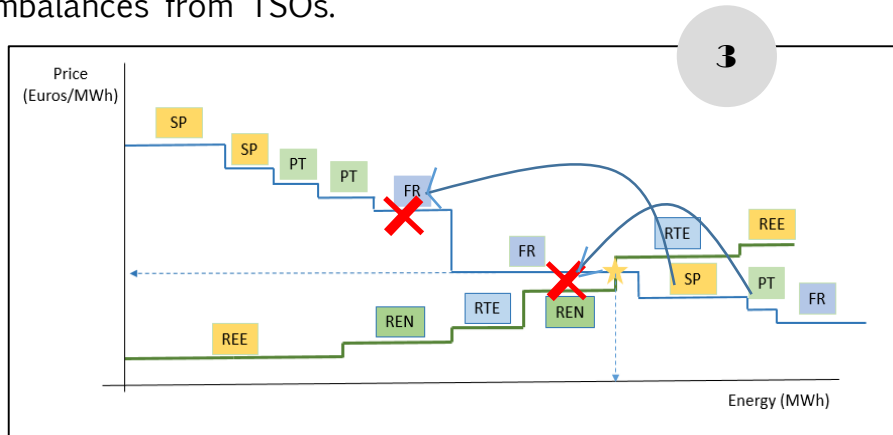

Figure 27: Unavailable interconnections. Change of the initially cleared curve

- All these situations prompt market splitting. In this case, it is important to consider that not all the systems involved in the clearing process may have different marginal prices -Figure 28. For this reason, before providing final results, the algorithm checks again interconnections so that it ensures systems marginal prices. If all interconnections would be congested, the situation would be the one represented in Figure 29.

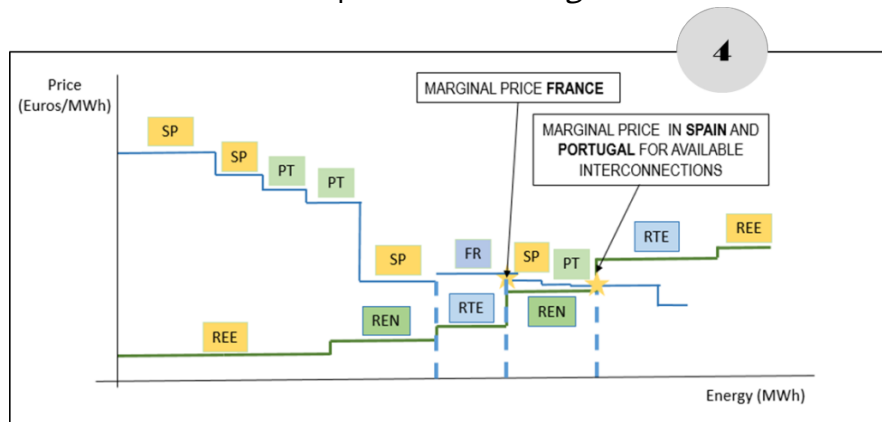

Figure 28: Market splitting. Marginal prices Case 1

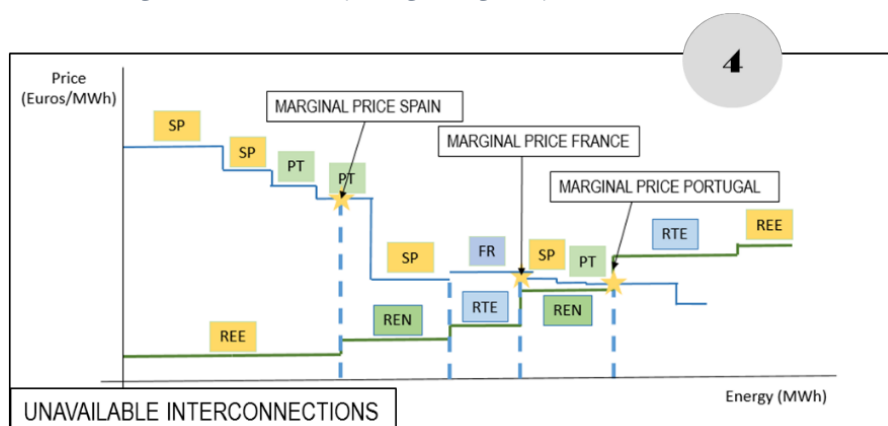

Figure 29: Market splitting. Marginal prices Case 2

- The following subroutine considers the non-cleared imbalances that remain after the clearing process. In other words, if upward/downward offers are still available and bid prices are lower/higher than priced TSOs upward/downward offers, these imbalances could still be covered.

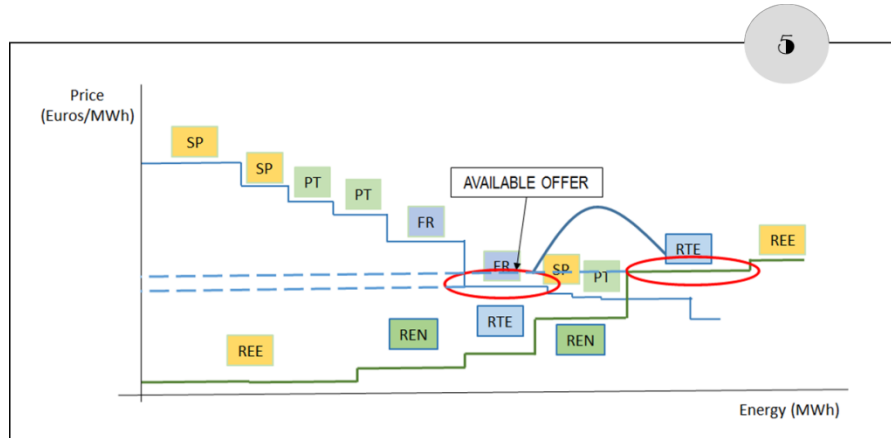

Figure 30: Offers still available after the clearing process

- Finally, the last subroutine calculates technical and economical results (i.e. market share, incomes...) for the company and their generating units.

Although these schemes are focused on the clearing process for downward imbalances, the reader must take into account that the same methodology is applied for upward imbalances.

Two-stage clearing process with infinite cross-border capacities

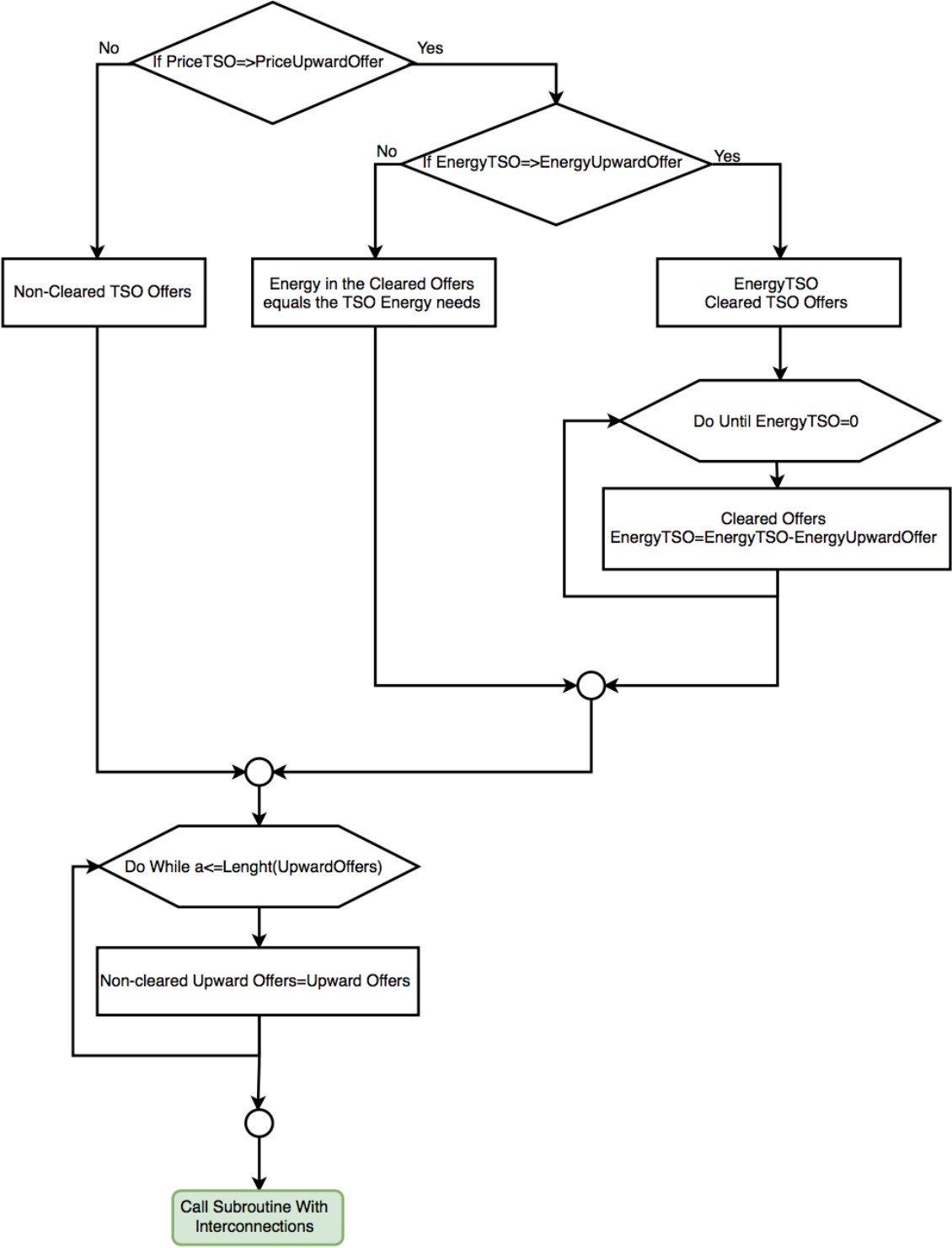

Figure 31: Two-stage clearing process with infinite interconnections. Flowchart

Two-stage clearing process considering interconnections

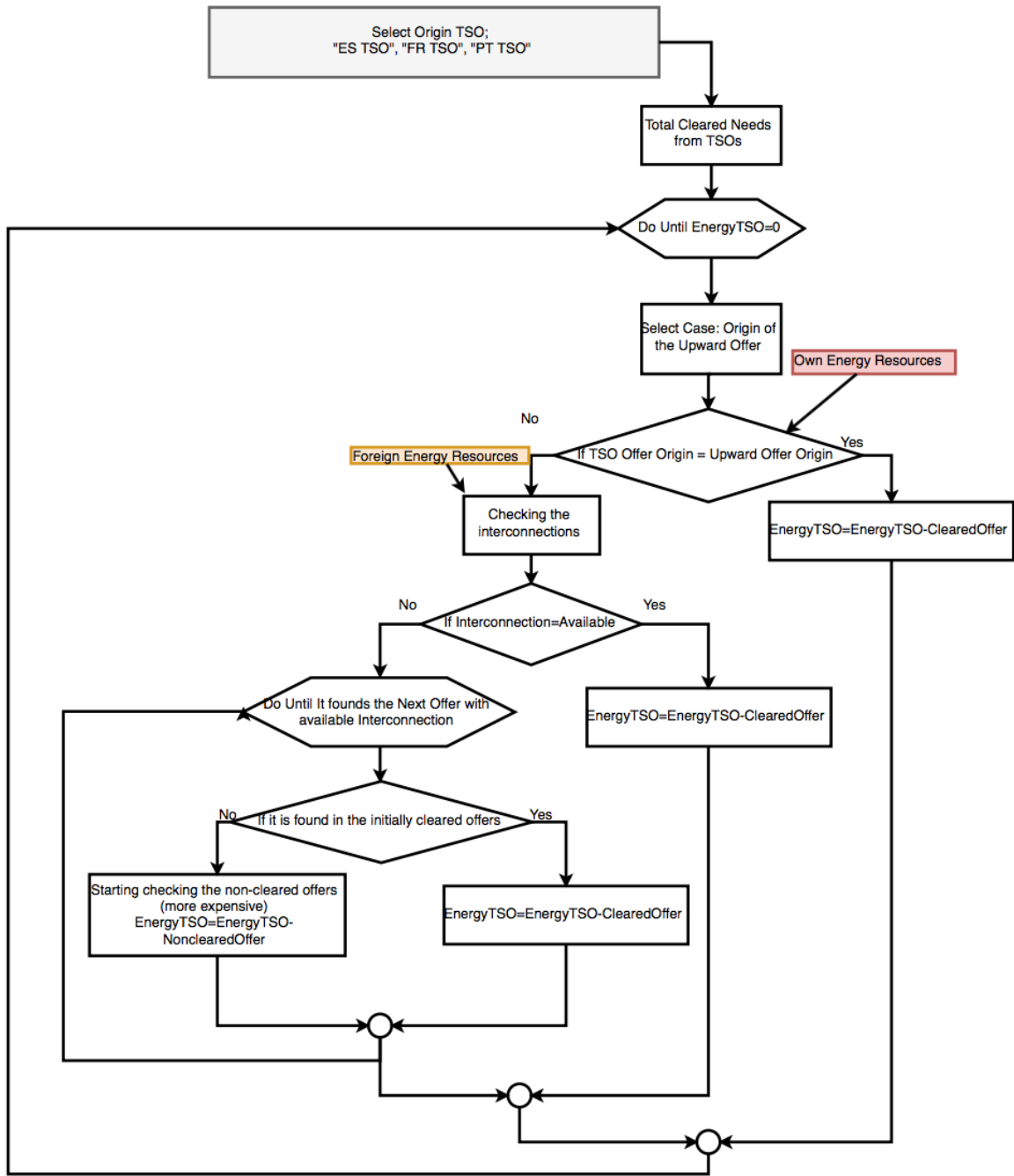

Figure 32: Two-stage clearing process with interconnections. Flowchart

### 3.6.2 Market Clearing Algorithm. One-stage clearing process

Subroutines in this case get more complicated, since several casuistries must be taken into account. These are structured as follows:

- Firstly, upward/downward offers are combined with downward/upward imbalances in accordance to the considered TSOs strategies.
- In the same way as in the two-stage clearing process, first subroutine considers infinite cross-border capacities. This provides the initial solution from which the different casuistries are considered taking into account available interconnections. In addition, this allows the user knowing the effect of interconnections in final results. Again, this case would be the one in which the social welfare would be optimum.

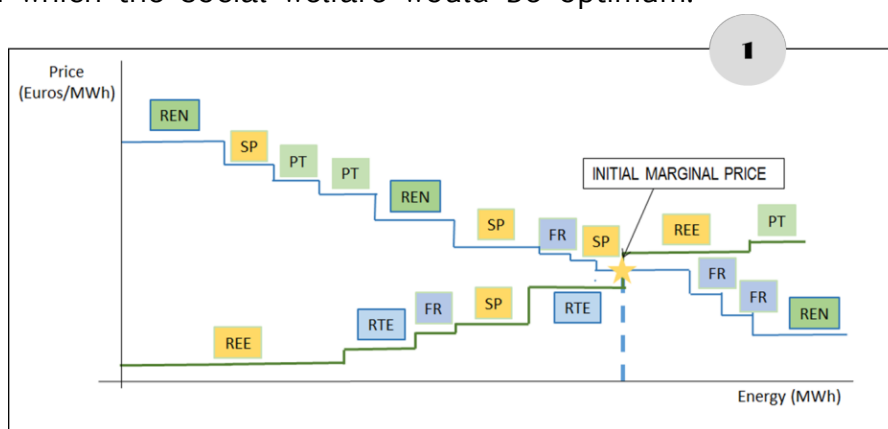

Figure 33: One-stage clearing process ideal solution.

- Furthermore, interconnections among countries are considered. At this point, the algorithm compares the origin and direction of offers and imbalances, given that all of them are combined. Within this subroutine, the algorithm considers:
  - If there are two imbalances of opposite directions and interconnections are available, these can be compensated. Here appears the so called implicitly netting.

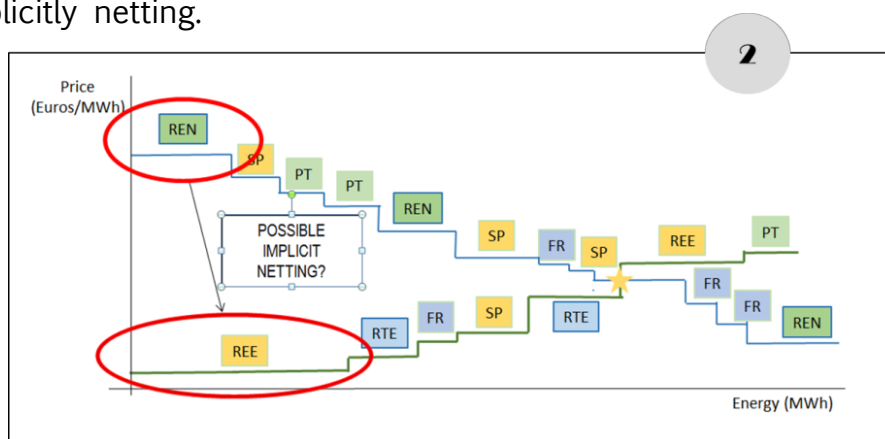

Figure 34: One-stage clearing process. Checking origin of offers/imbalances

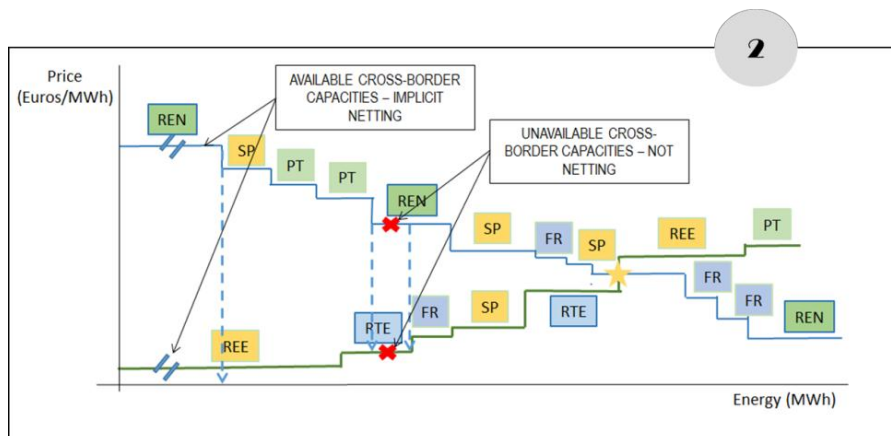

Figure 35: Subroutine for implicitly netting

- Upward/downward offers with upward/downward imbalances are cleared following the same methodology as in the two-stage process.
- It has been considered that two service providers can cleared their offers.

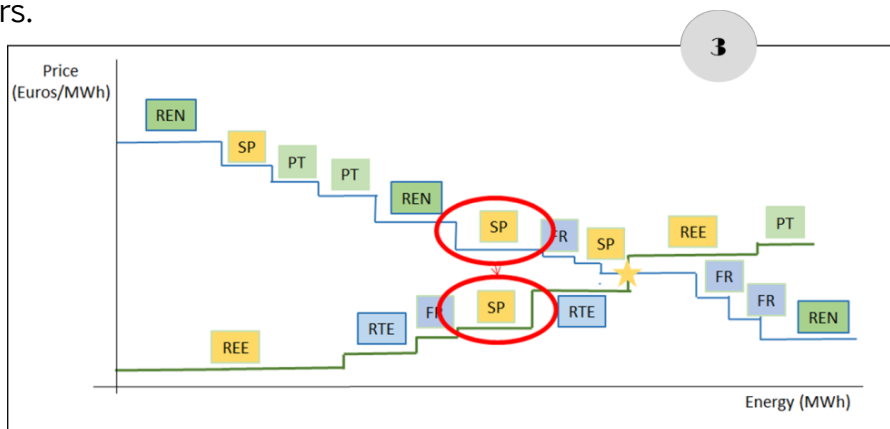

Figure 36: Casuistry with two services providers in the clearing process

- When interconnections are congested, the algorithms looks for the next offer -within the initially non-cleared offers- able to cover imbalances. Note that in this case it is necessary to check upward/downward non-cleared curves depending on the direction of the imbalance.

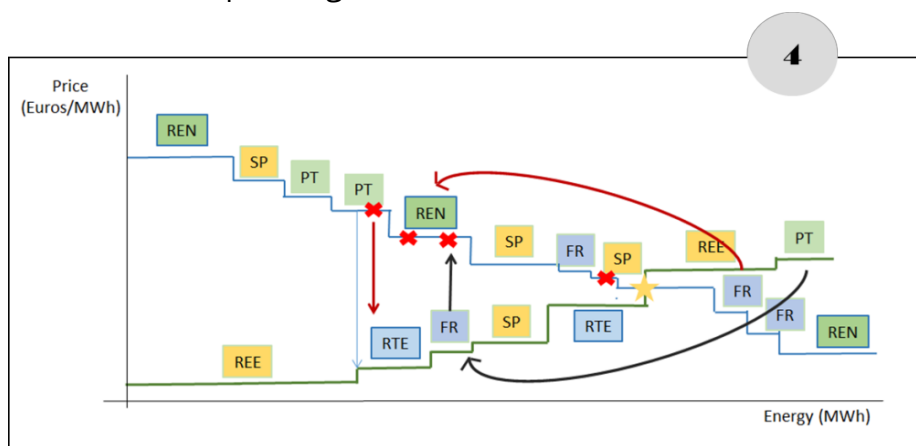

Figure 37: Interconnections congestion. Change in the initially cleared curves

- When congestions occur, market splitting takes place. Consequently, each system possesses different marginal prices. Again, this involves a reduction of social welfare.

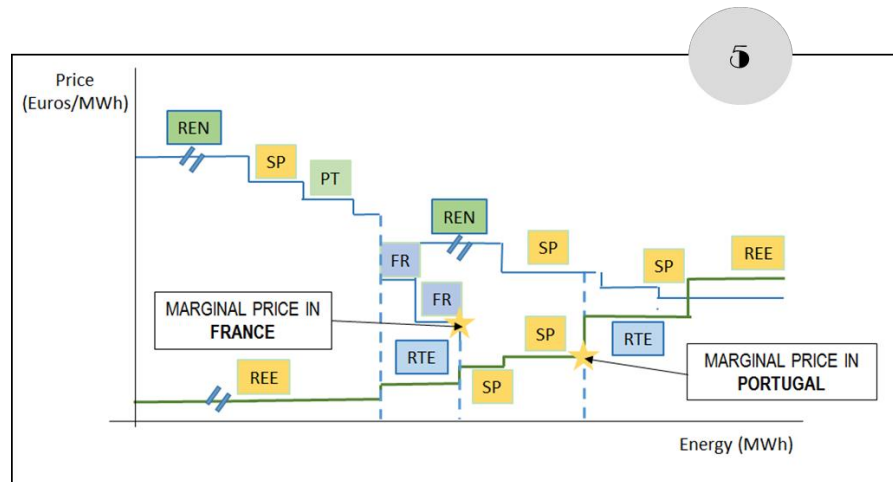

Figure 38: Market Splitting. Systems' marginal prices

- Last subroutine calculates technical and economic results for Endesa and their generating units.



One-stage clearing process considering interconnections

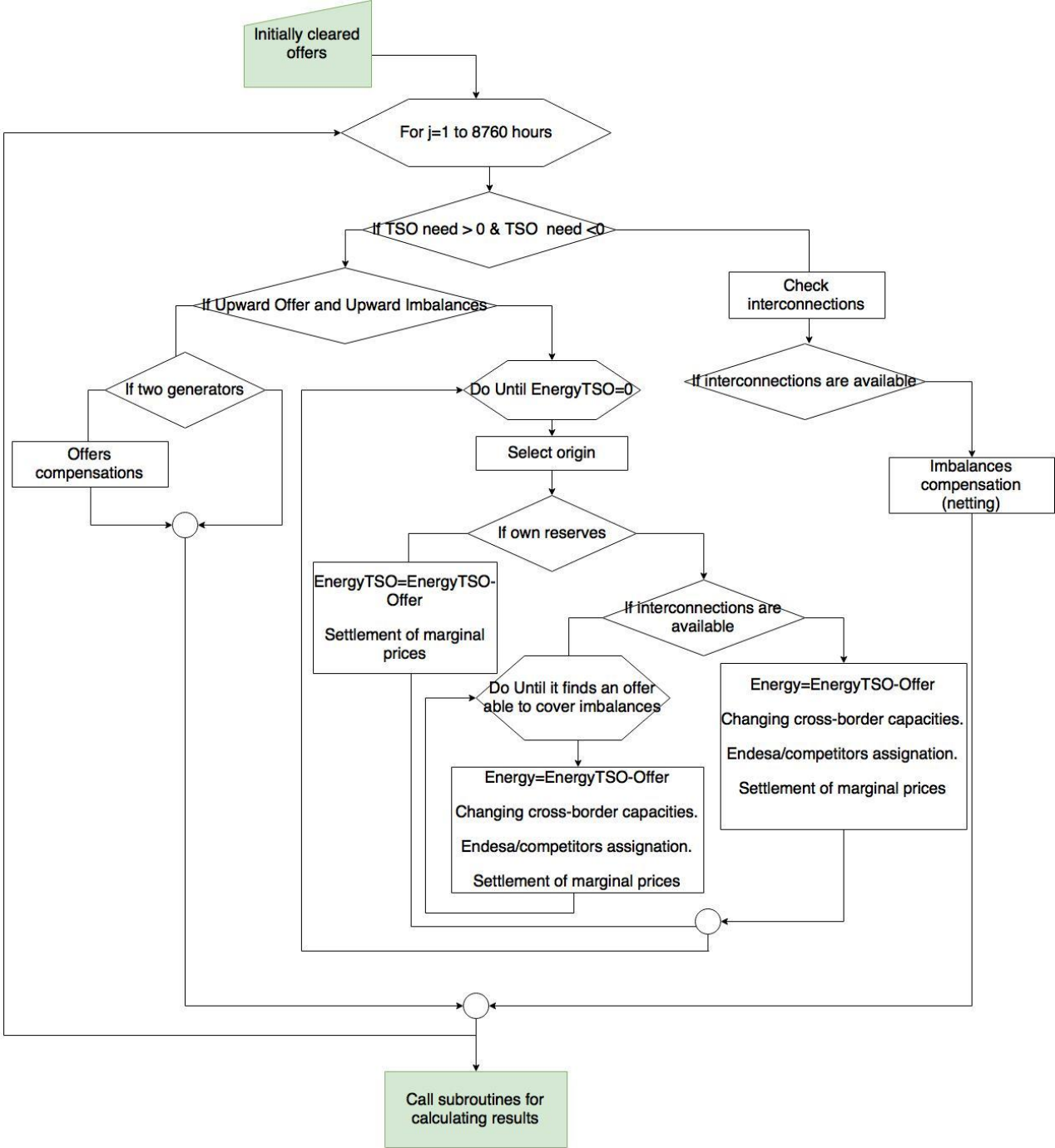

Figure 39: One-stage clearing process flowchart

## 4. Analysis of scenarios

This section focuses on the comparison among the results from the previous forecasting tool –base case– and the new one, which includes pre-netting of imbalances needs, TSOs pricing strategies, two-stage clearing process and implicitly netting in the one-stage clearing process.

Before starting the description of each scenario, the following considerations must be taken into account:

- Imbalances historical data for each country of study does not allow the differentiation of Replacement Reserves. Whereas France and Portugal possess aggregated results regarding RR, Spain differentiates between imbalances management and part of tertiary reserves.
- There is not historical data concerning priced TSOs needs. One must take into account that the defined strategy is based on hypothesis, which at the end, may not properly reflect real situations.
- The European Target model for continuous trading in Intraday markets (XBID) may affect real time imbalances, reducing thus the volume of imbalances used in TERRE platform.

### **4.1 Pre-netting of Imbalances vs. Base Case**

This scenario compares the results between the base case –system imbalances were fully covered– with respect to the results obtained from the implementation of the pre-netting algorithm.

At this point, some assumptions can be made in order to check final results:

- Pre-netting imbalances will result in lower imbalances with respect to the previous situation.
- This reduction of volumes does not mean that imbalances have not been covered; however, they have been compensated among involved systems.
- The lower the imbalances the lower the marginal prices for upward needs and, on the other hand, the higher the marginal prices for downward needs.

The following chart summarises the impact of pre-netting imbalances in global upward/downward volumes and final prices, per system.

NETTING IMPACT ON VOLUMES (TWh)						
	NEW VOLUMES OF UPWARD ACTIVATIONS	INITIAL VOLUMES OF UPWARD ACTIVATIONS	NEW VOLUMES OF DOWNWARD ACTIVATIONS	INITIAL VOLUMES OF DOWNWARD ACTIVATIONS	DIFFERERE ON UPWARD ACTIVATIONS	DIFFERENCE ON DOWNWARDS ACTIVATIONS
PORTUGAL	444,1	833,0	-625,8	-1067,4	-46,7%	-41,4%
SPAIN	3697,7	4139,4	-1660,8	-2049,5	-10,7%	-19,0%
FRANCE	1432,5	1712,5	-3493,0	-4249,3	-16,3%	-17,8%
TOTAL	5574,3	6684,9	-5779,6	-7366,2	-16,6%	-21,5%

NETTING IMPACT ON PRICES (€/MWh)						
	NEW PRICES OF UPWARD ACTIVATIONS	INITIAL PRICES OF UPWARD ACTIVATIONS	NEW PRICES OF DOWNWARD ACTIVATIONS	INITIAL PRICES OF DOWNWARD ACTIVATIONS	DIFFERERE ON UPWARD ACTIVATIONS	DIFFERENCE ON DOWNWARDS ACTIVATIONS
PORTUGAL	46,80	46,11	35,96	37,54	1,51%	-4,21%
SPAIN	53,79	54,56	34,72	33,33	-1,41%	4,15%
FRANCE	32,70	33,27	12,53	12,41	-1,72%	0,99%
TOTAL	47,81	48,05	21,44	21,87	-0,50%	-1,96%

Chart 1: Impact of pre-netting imbalances vs. base case

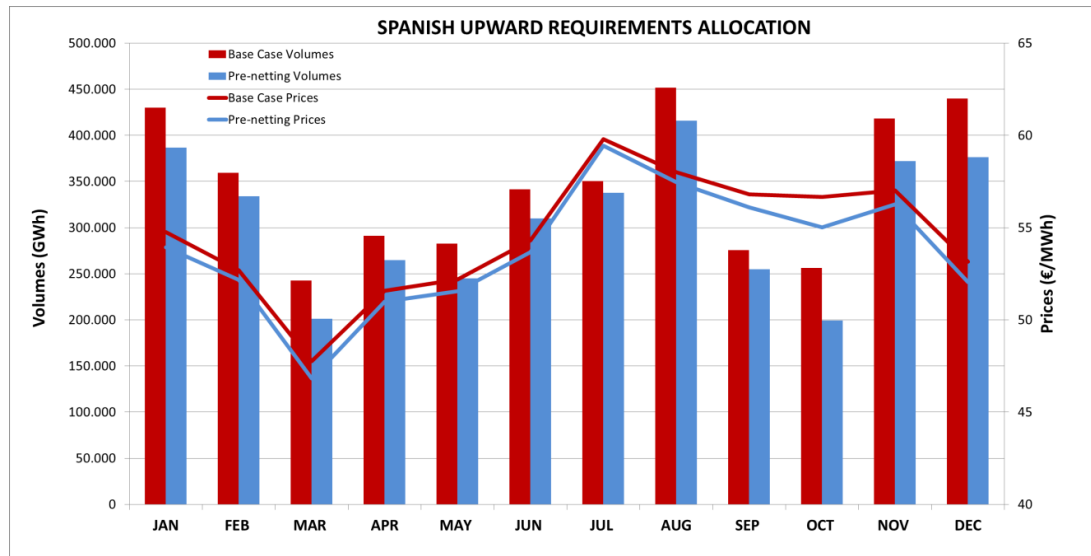

Figure 40: Pre-netting vs. base case. Upward Imbalances in Spain

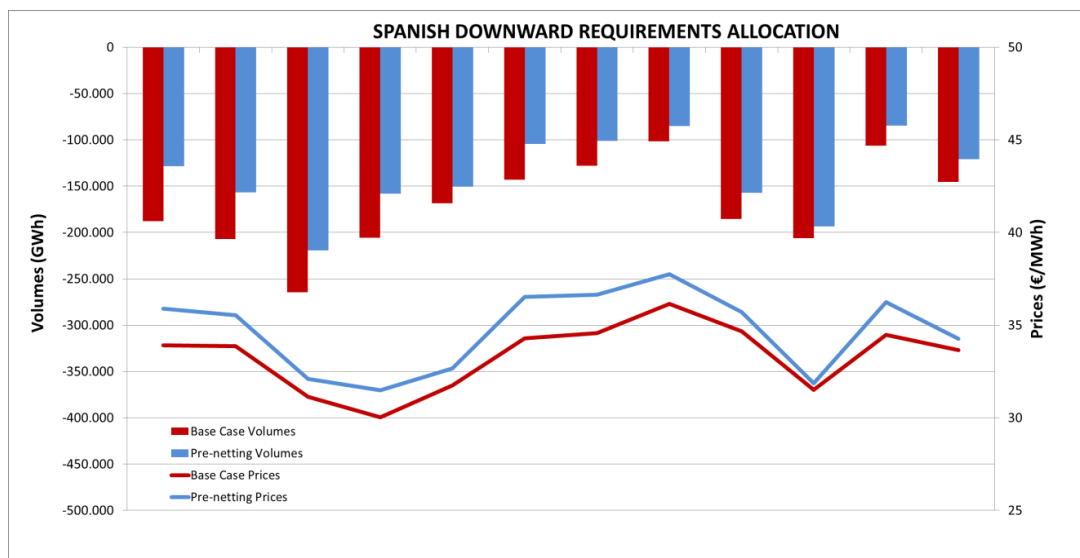

Figure 41: Pre-netting vs. base case. Downward Imbalances in Spain

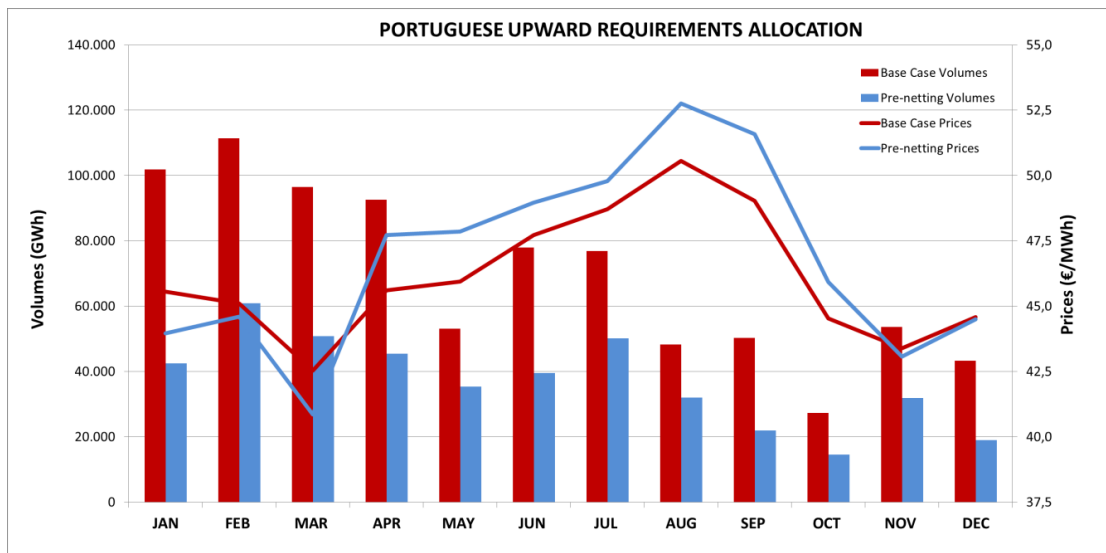

Figure 42: Pre-netting vs. base case. Upward Imbalances in Portugal

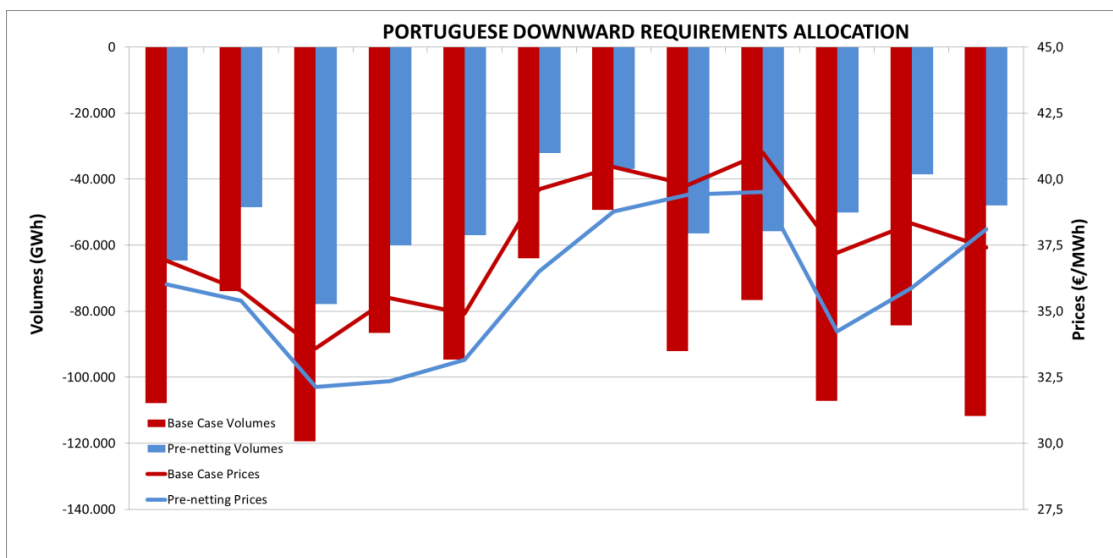

Figure 43: Pre-netting vs. base case. Downward Imbalances in Portugal

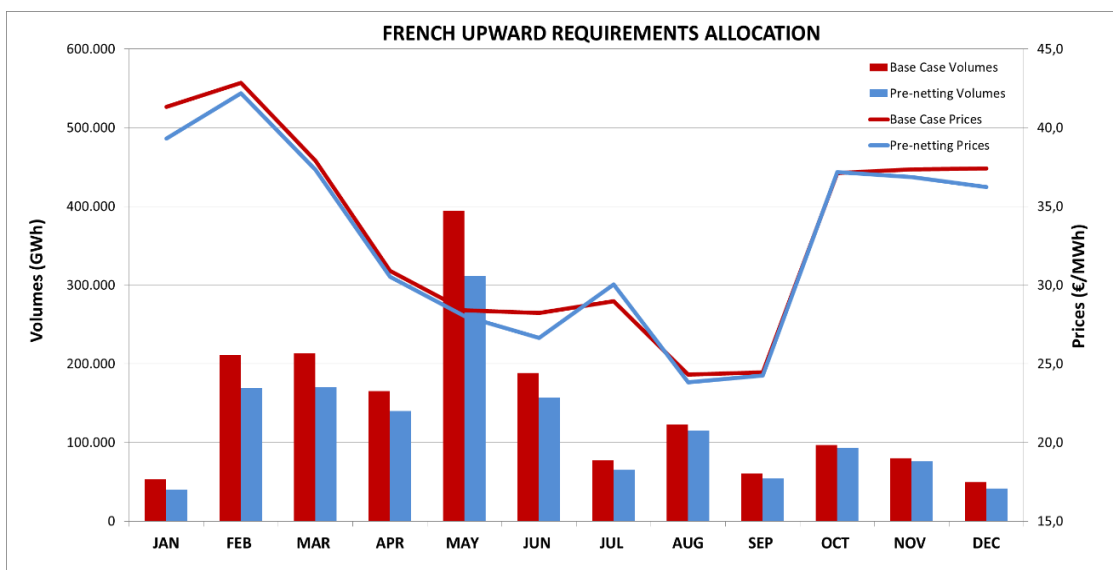

Figure 44: Pre-netting vs. base case. Upward Imbalances in France

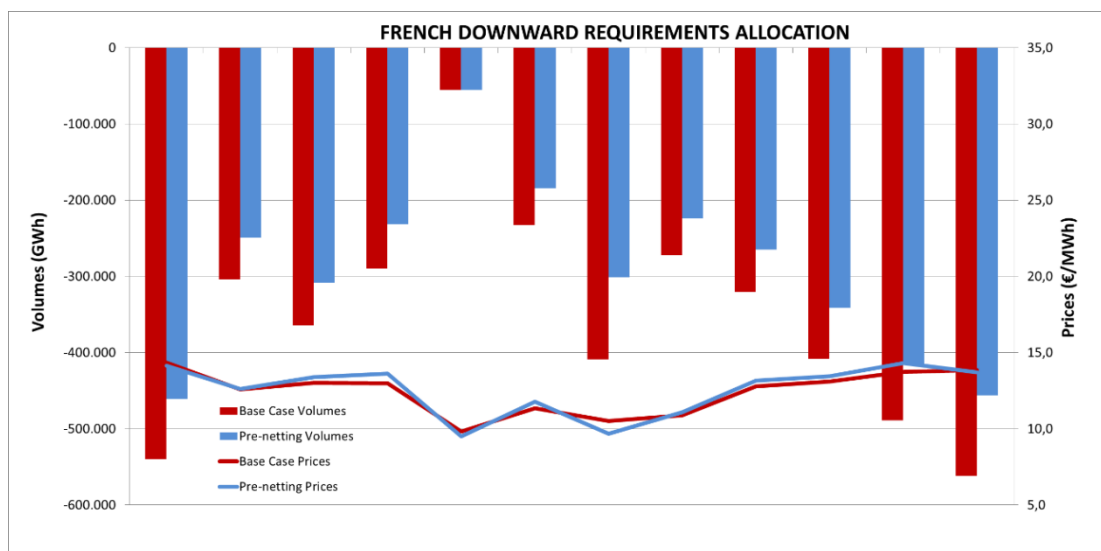

Figure 45: Pre-netting vs. base case. Downward Imbalances in France

The reader may think that there are incongruences with respect to Portuguese results, since there are some months where upward/downward volumes and prices do not comply with the previously mentioned assumptions. However, we must take into account that we are dealing with lower imbalances so that average marginal prices may be affected. Analysing a concrete month (i.e. April) where results go in the opposite way as one may think, we can observe that by pre-netting volumes, some hours where there initially were imbalances show now zero imbalances. The former are quantified in the calculation of average prices, affecting thus results.

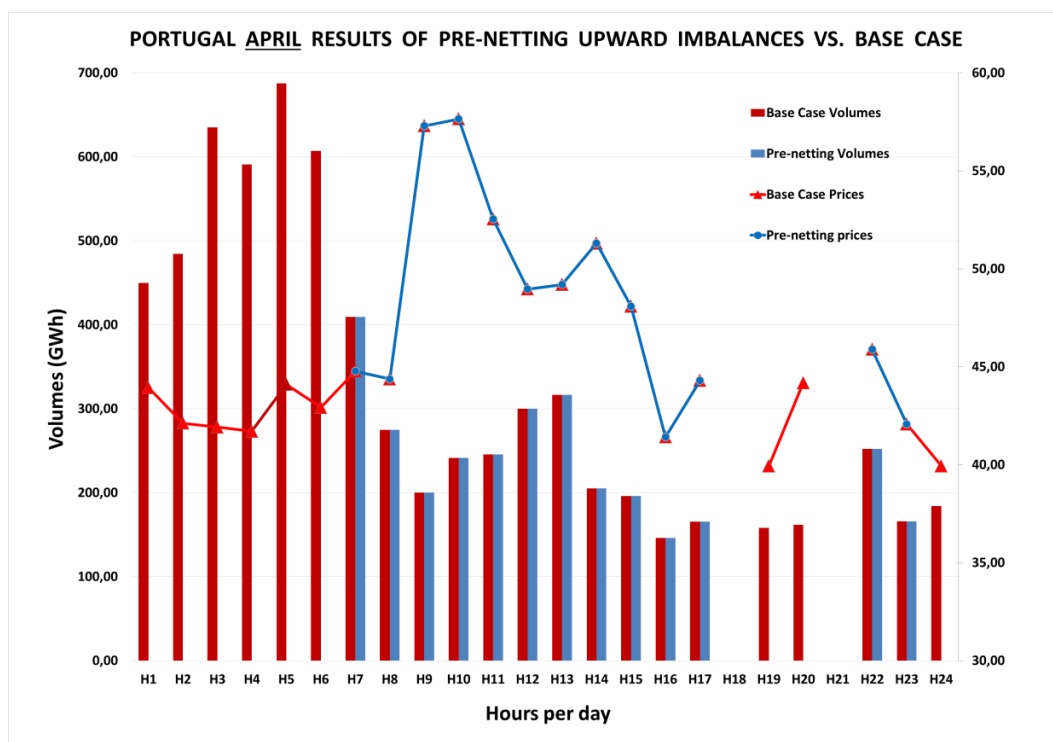

Figure 46: Pre-netting vs. base case. Portugal Case

## 4.2 Pricing Imbalances vs. Base Case.

This scenario is based on a comparison among the base case and TSOs priced imbalances. As a difference with respect to the assumptions in the previous scenarios, the reduction of the volume of imbalances is a consequence of TSOs decisions. Whereas in the first case all imbalances were covered, now System Operators may decide to leave certain imbalances uncovered for using them in other markets.

PRICING TSO IMPACT ON VOLUMES (TWh)						
	NEW VOLUMES OF UPWARD ACTIVATIONS	INITIAL VOLUMES OF UPWARD ACTIVATIONS	NEW VOLUMES OF DOWNWARD ACTIVATIONS	INITIAL VOLUMES OF DOWNWARD ACTIVATIONS	DIFFERERE ON UPWARD ACTIVATIONS	DIFFERENCE ON DOWNWARDS ACTIVATIONS
<b>PORTUGAL</b>	545,4	833,0	-700,3	-1067,4	-34,5%	-34,4%
<b>SPAIN</b>	2732,0	4139,4	-1352,7	-2049,5	-34,0%	-34,0%
<b>FRANCE</b>	1093,0	1712,5	-1436,2	-4249,3	-36,2%	-66,2%
<b>TOTAL</b>	4370,4	6684,9	-3489,2	-7366,2	-34,6%	-52,6%

PRICING TSO IMPACT ON PRICES (€/MWh)						
	NEW PRICES OF UPWARD ACTIVATIONS	INITIAL PRICES OF UPWARD ACTIVATIONS	NEW PRICES OF DOWNWARD ACTIVATIONS	INITIAL PRICES OF DOWNWARD ACTIVATIONS	DIFFERERE ON UPWARD ACTIVATIONS	DIFFERENCE ON DOWNWARDS ACTIVATIONS
<b>PORTUGAL</b>	44,69	46,11	39,73	37,54	-3,1%	5,8%
<b>SPAIN</b>	51,89	54,56	34,66	33,33	-4,9%	4,0%
<b>FRANCE</b>	32,17	33,27	18,12	12,41	-3,3%	46,0%
<b>TOTAL</b>	46,06	48,05	28,87	21,87	-4,1%	32,0%

Chart 2: Impact of pricing TSOs needs vs. base case

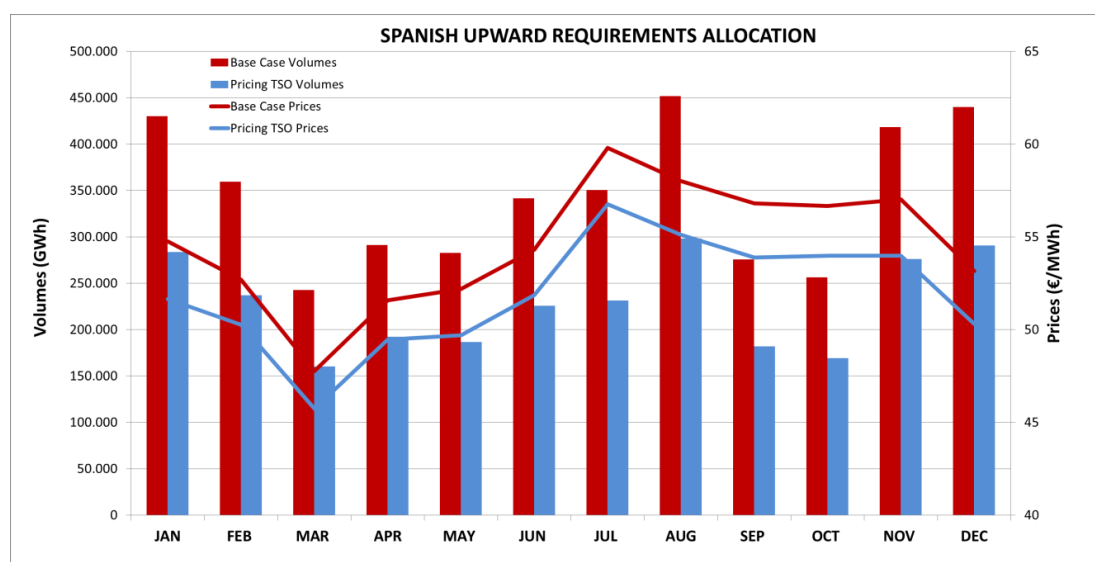

Figure 47: Pricing imbalances vs. base case. Upward Imbalances in Spain

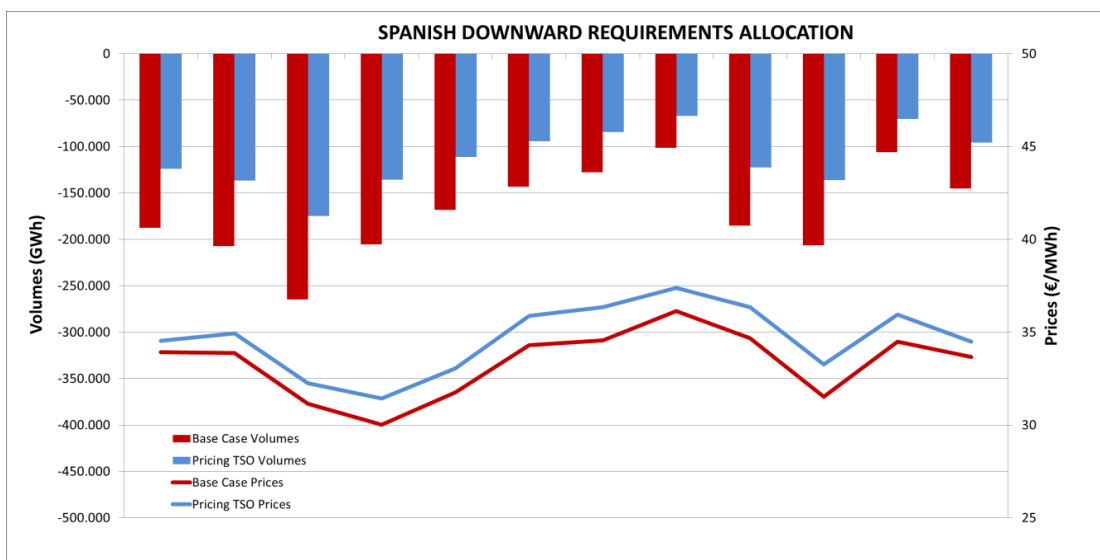

Figure 48: Pricing Imbalances vs. base case. Downward Imbalances in Spain

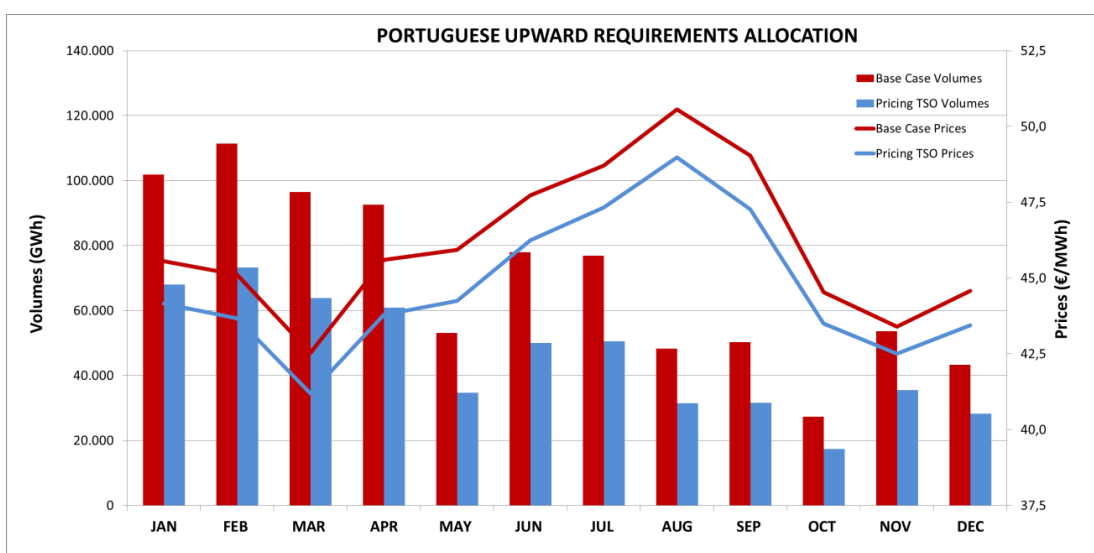

Figure 49: Pricing Imbalances vs. base case. Upward Imbalances in Portugal

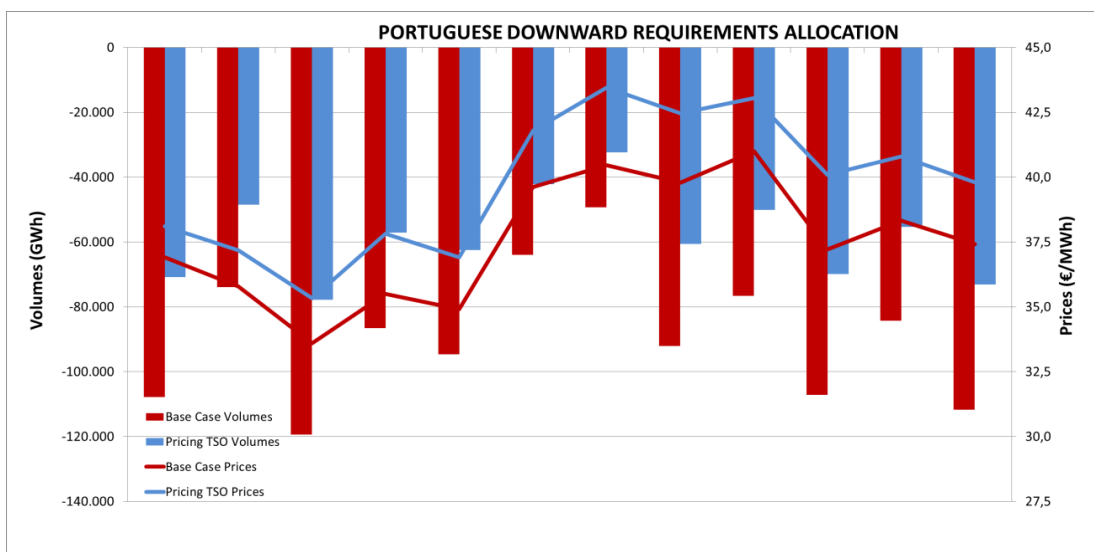

Figure 50: Pricing Imbalances vs. base case. Downward Imbalances in Portugal

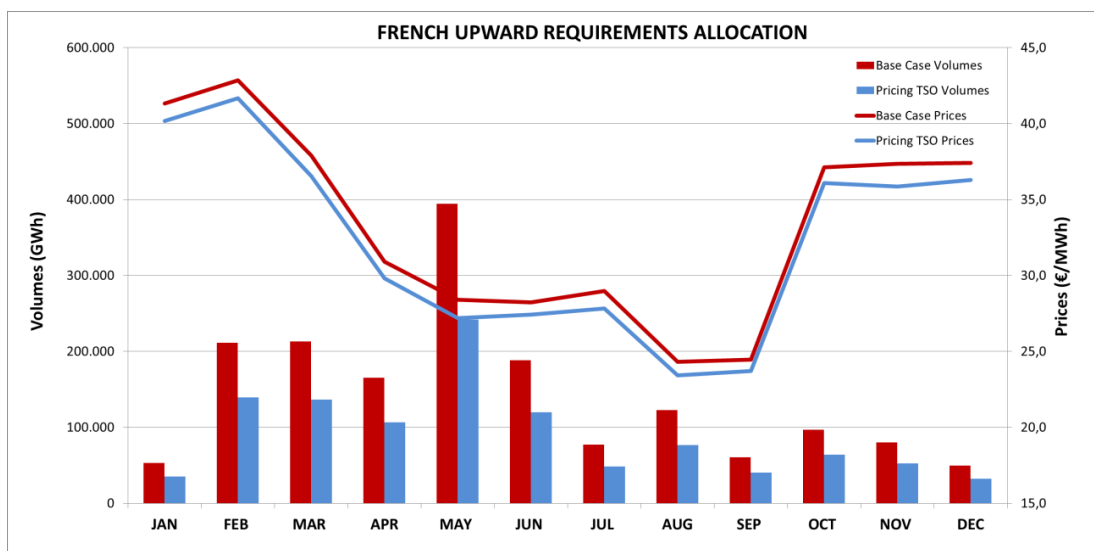

Figure 51: Pricing Imbalances vs. base case. Upward Imbalances in France

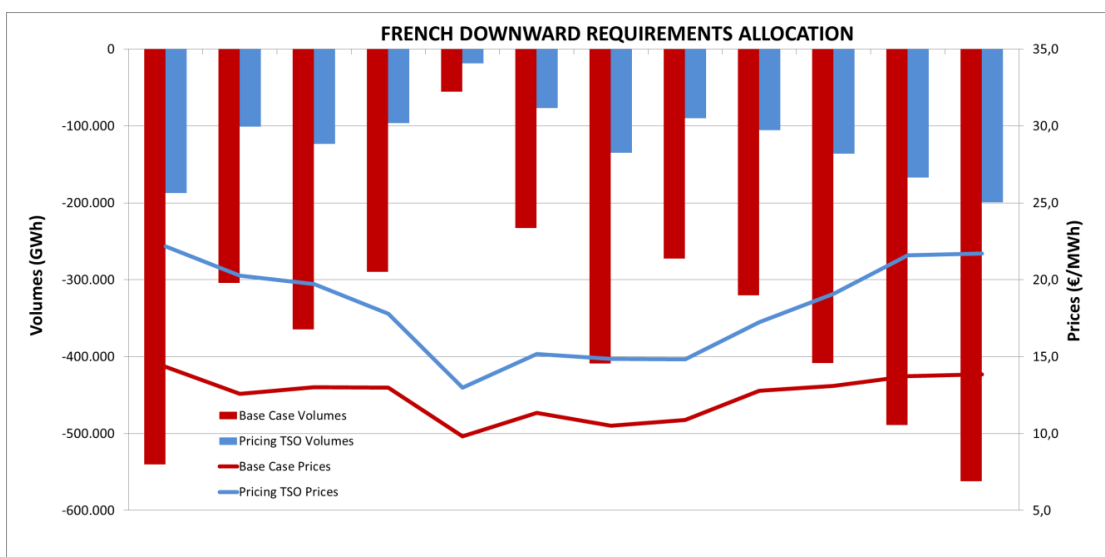

Figure 52: Pricing Imbalances vs. base case. Downward Imbalances in France

Results obtained vary widely depending on the defined strategy. In this case, we have assumed a strategy in which TSOs are willing to certainly cover two thirds of initial imbalances. Residual imbalances are defined with high/low prices for downward/upward imbalances in order to ensure that these are not cleared. Hence, we can observe that TSOs strategies have a strong effect in final results.

### 4.3 Pre-netting and Pricing Imbalances vs. Base Case

This scenario shows the effect of pre-netting both, pricing imbalances and the base case volumes. One can assume that by pricing and pre-netting imbalances, final volumes could be still lower with respect to the previous cases.



NETTING+PRICING IMPACT ON VOLUMES (TWh)						
	NEW VOLUMES OF UPWARD ACTIVATIONS	INITIAL VOLUMES OF UPWARD ACTIVATIONS	NEW VOLUMES OF DOWNWARD ACTIVATIONS	INITIAL VOLUMES OF DOWNWARD ACTIVATIONS	DIFFERERE ON UPWARD ACTIVATIONS	DIFFERENCE ON DOWNWARDS ACTIVATIONS
PORTUGAL	287,1	833,0	-409,3	-1067,4	-65,5%	-61,7%
SPAIN	2440,5	4139,4	-1095,7	-2049,5	-41,0%	-46,5%
FRANCE	924,1	1712,5	-1178,3	-4249,3	-46,0%	-72,3%
TOTAL	3651,7	6684,9	-2683,2	-7366,2	-45,4%	-63,6%

NETTING+PRICING IMPACT ON PRICES (€/MWh)						
	NEW PRICES OF UPWARD ACTIVATIONS	INITIAL PRICES OF UPWARD ACTIVATIONS	NEW PRICES OF DOWNWARD ACTIVATIONS	INITIAL PRICES OF DOWNWARD ACTIVATIONS	DIFFERERE ON UPWARD ACTIVATIONS	DIFFERENCE ON DOWNWARDS ACTIVATIONS
PORTUGAL	45,11	46,11	37,45	37,54	-2,2%	-0,2%
SPAIN	51,38	54,56	36,16	33,33	-5,8%	8,5%
FRANCE	31,62	33,27	18,14	12,41	-4,9%	46,1%
TOTAL	45,89	48,05	28,44	21,87	-4,5%	30,0%

Chart 3: Impact of pre-netting and pricing vs. base case

Following the same reasoning for seeing the impact on prices, the lower the volume of upward imbalances, the lower the price. In the opposite way, the lower the volume of downward imbalances, the higher the price. Results clearly show these consequences.

In the case of pre-netting and priced imbalances, the reduction of the initial volume is a result from the compensation of systems –covered imbalances– and TSOs strategies –uncovered imbalances.

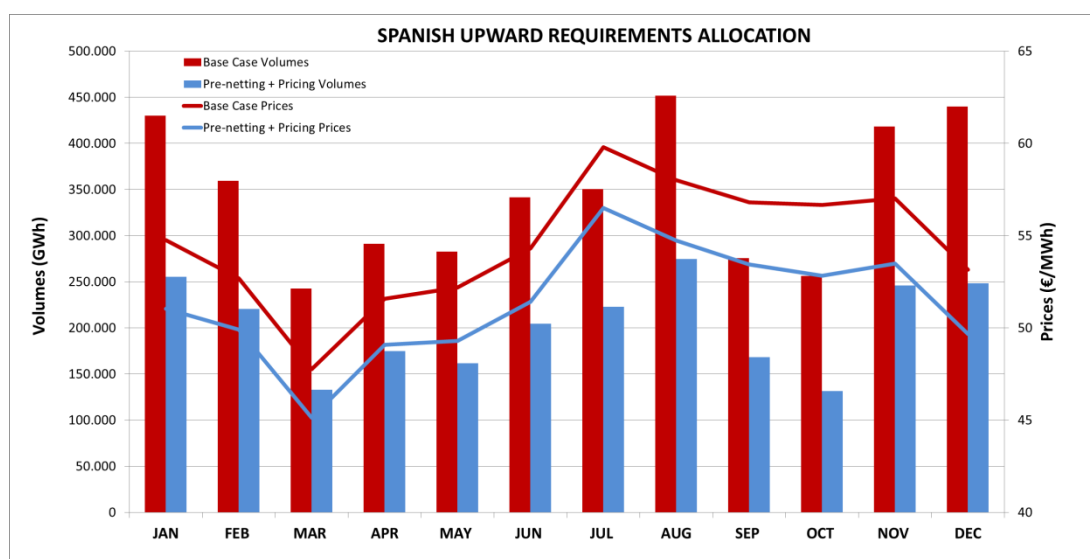

Figure 53: Pre-netting and pricing imbalances vs. base case. Downward Imbalances in Spain

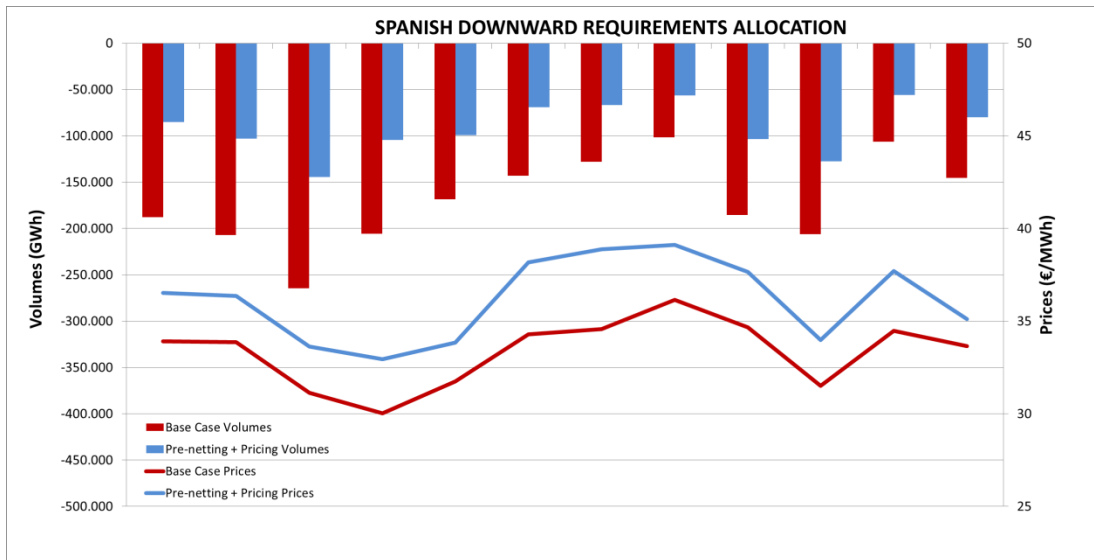

Figure 54: Pre-netting and pricing imbalances vs. base case. Upward Imbalances in Portugal

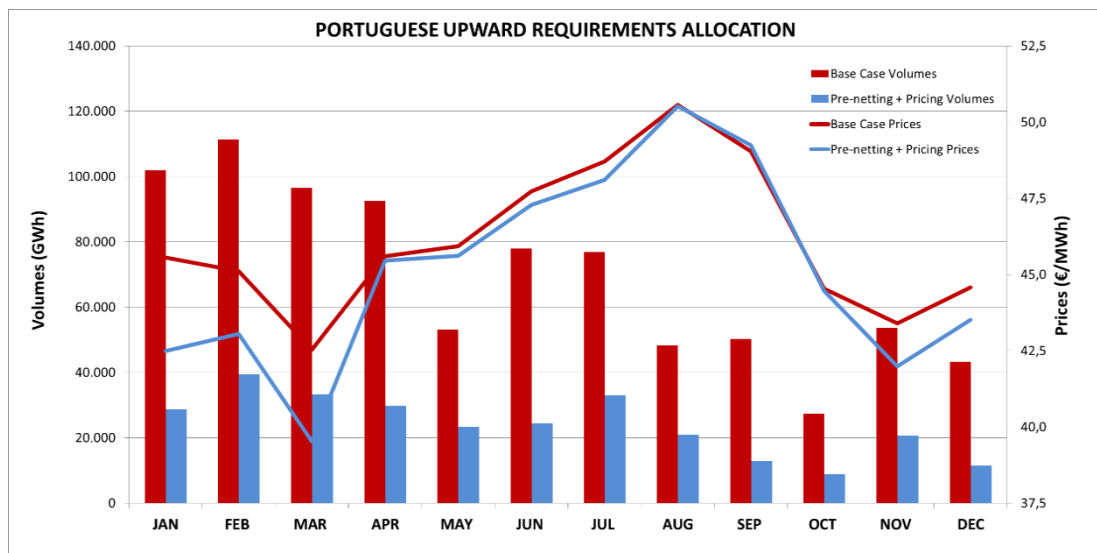

Figure 55: Pre-netting and pricing imbalances vs. base case. Upward Imbalances in Portugal

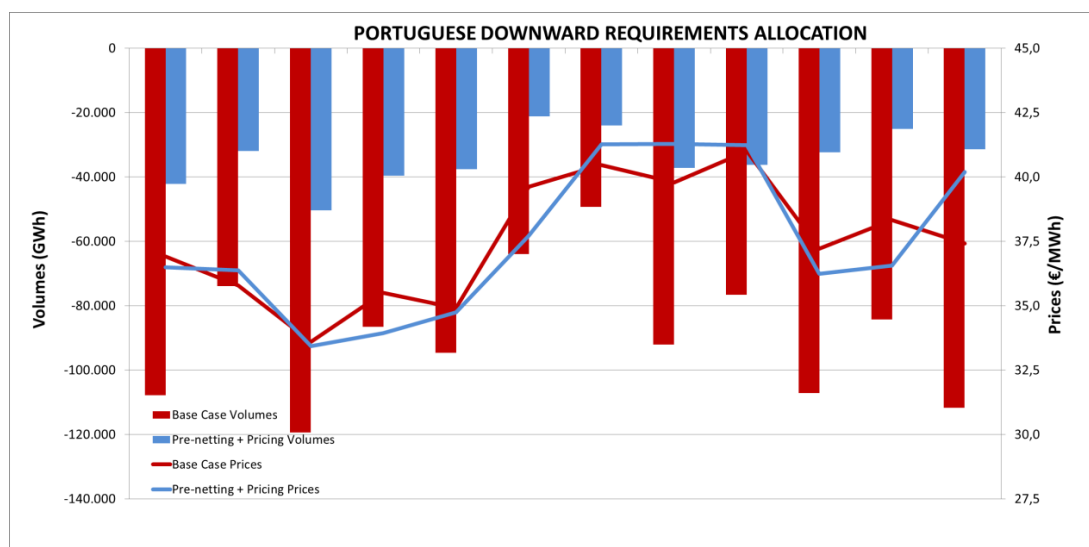

Figure 56: Pre-netting and pricing imbalances vs. base case. Downward Imbalances in Portugal

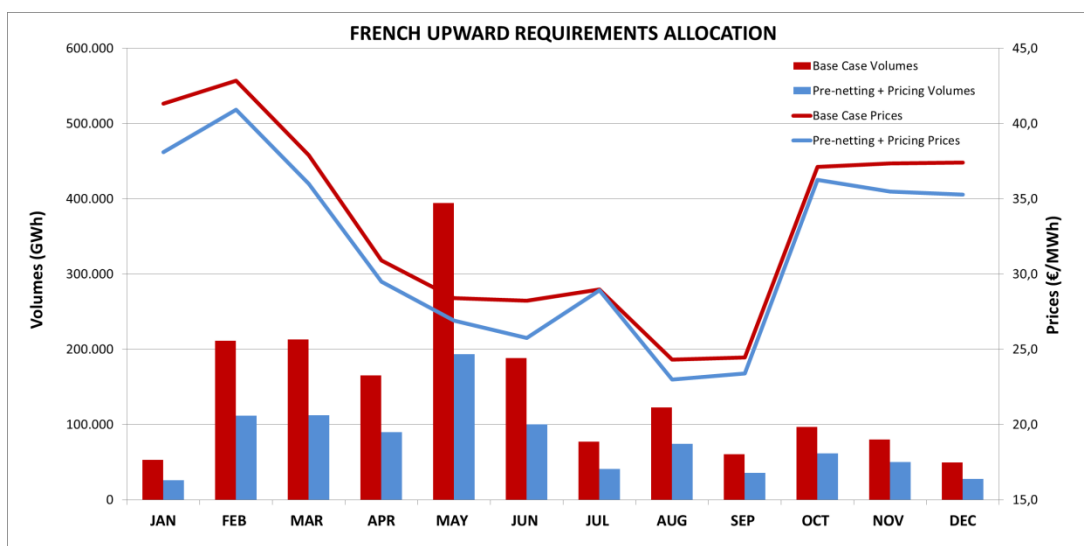

Figure 57: Pre-netting and pricing imbalances vs. base case. Upward Imbalances in France

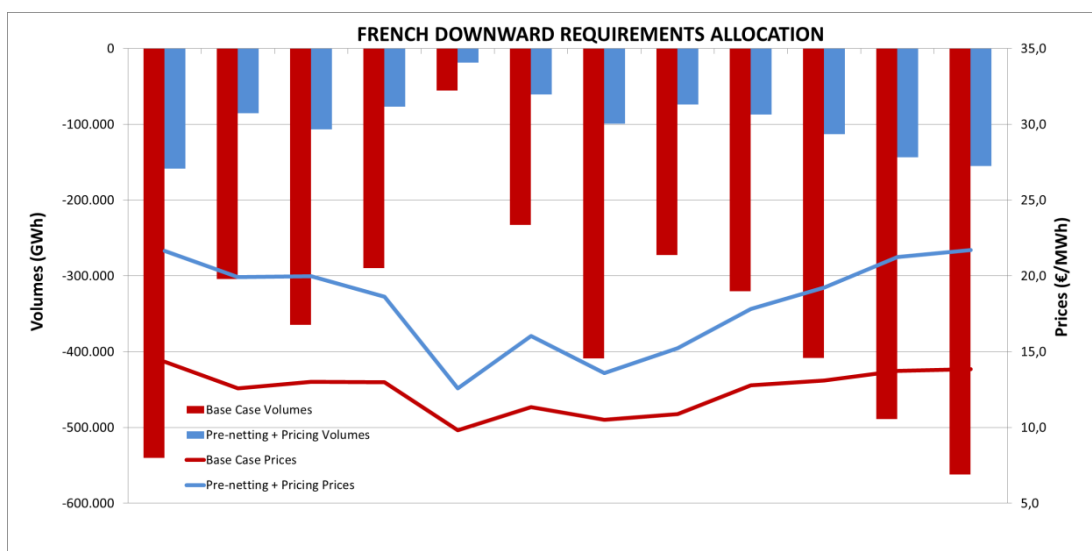

Figure 58: Pre-netting and pricing imbalances vs. base case. Downward Imbalances in France

Next *Figure* summarises the impact of pre-netting volumes, uncovered needs due to pricing TSOs strategies and assigned resources for each considered system. From these results we can observe:

- Spain and France mostly cover their total imbalances with own resources.
- Taking advantage of available interconnections between Spain and Portugal -when both systems are coupled- a considerable amount of imbalances is netted.
- Due to congestions between France and Spain, the amount of netted imbalances is limited.
- The impact of TSOs strategies may have a strong effect on final results.

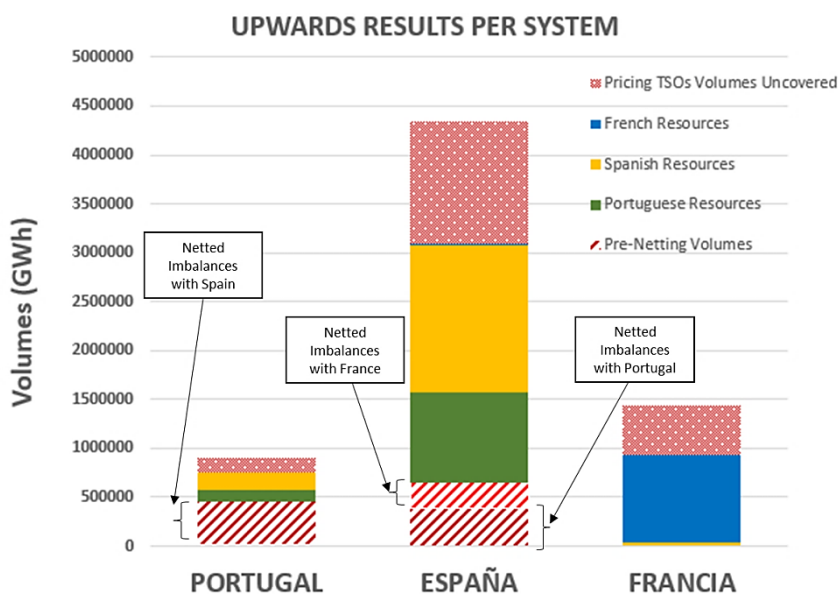

Figure 59: Pre-netting and pricing imbalances vs. base case. Upward results per system

Taking into account the considerations we have decided, results for downward imbalances show similar results as those for upward imbalances.

#### 4.4 Comparison between all scenarios

The following *Figures* summarise results from each scenario and system in such a way that the reader can visually observe the impact in upward/downward volumes with the implemented algorithms.

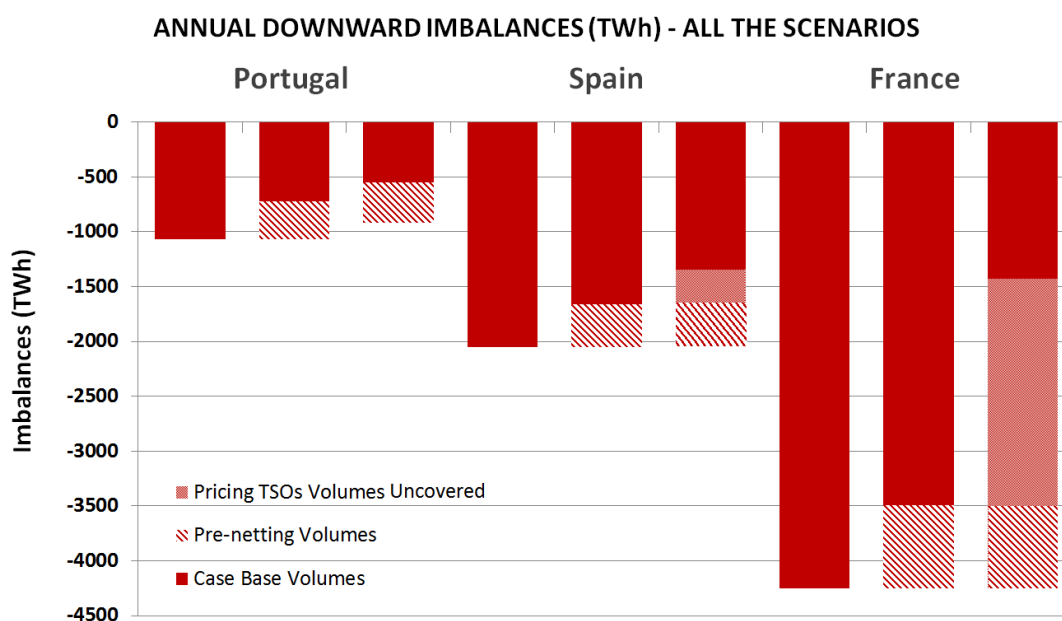

Figure 60: All scenarios annual upward volumes

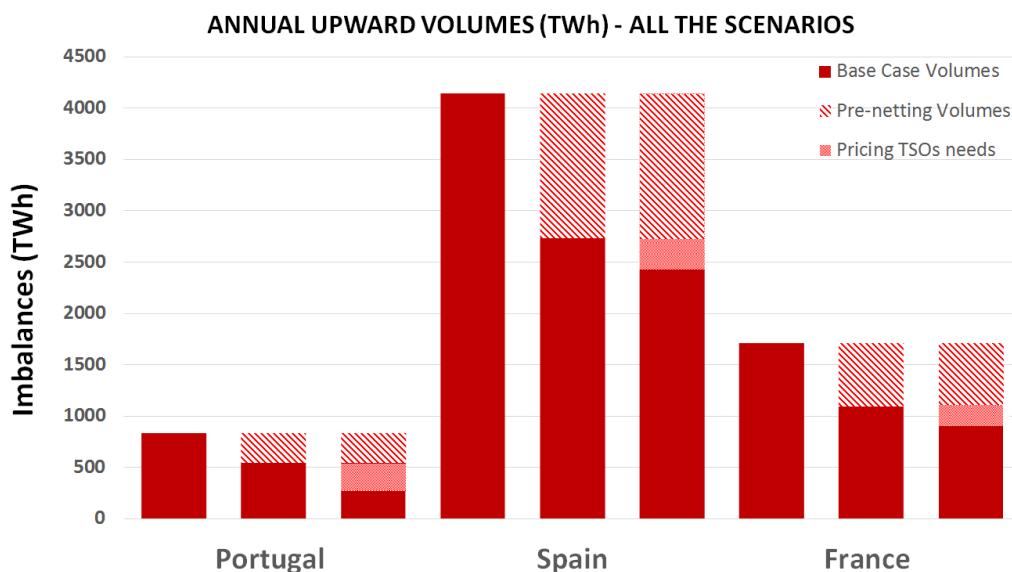

Figure 61: All scenarios annual downward imbalances

#### 4.5 One-Stage Clearing Process vs. Two-Stage Clearing Process.

During the development and analysis of this scenario we have found certain situations that must be clearly clarified. For doing that, we have decided to choose an aleatory hour in order to check and compare the different casuistries that may happen when comparing the one-stage clearing process with the two-stage one.

<u>WITH</u> PRE-NETTING AND PRICING STRATEGIES						
TWO STAGE-CLEARING PROCESS						
SYSTEMS	PORTUGAL		SPAIN		FRANCE	
IMBALANCES	UPWARDS (MWh)	DOWWARDS (MWh)	UPWARDS (MWh)	DOWWARDS (MWh)	UPWARDS (MWh)	DOWWARDS (MWh)
ORIGINAL IMBALANCES	427,14			-813,54		-489,31
NETTED IMBALANCES	-427,14			386,40		0
COVERED IMBALANCES	427,14			-255,02		-161,47
UNCOVERED IMBALANCES	0			-558,52		-327,84
ONE-STAGE CLEARING PROCESS						
SYSTEMS	PORTUGAL		SPAIN		FRANCE	
IMBALANCES	UPWARDS (MWh)	DOWWARDS (MWh)	UPWARDS (MWh)	DOWWARDS (MWh)	UPWARDS (MWh)	DOWWARDS (MWh)
ORIGINAL IMBALANCES	427,14			-813,54		-489,31
NETTED IMBALANCES	-427,14			386,40		0
COVERED IMBALANCES	427,14			-255,02		-161,47
UNCOVERED IMBALANCES	0			-558,52		-327,84

Chart 4: Comparison between pre-netting and pricing strategies among one/two-stage

From these results, the following conclusions can be got:

- When TSOs establish a strategy for pricing their imbalances and, on the other hand, pre-netting is applied, both clearing processes provide the same results. By pre-netting we are compensating system imbalances inasmuch as interconnections allow it and without considering the restrictions that TSOs strategies could impose. Hence, this makes sense since we are applying the same assumptions and input data: 1) Same TSOs strategies; 2) Net volumes used in the clearing processes would not have opposite directions –requirement for netting; 3) This consequence lead us in the same situation as in the two stage clearing process, where imbalances are only handled with Balancing Service Providers (BSPs).

<b>WITHOUT PRE-NETTING &amp; PRICING STRATEGIES</b>						
<b>TWO-STAGE CLEARING PROCESS</b>						
<b>SYSTEMS</b>	<b>PORTUGAL</b>		<b>SPAIN</b>		<b>FRANCE</b>	
<b>IMBALANCES</b>	UPWARDS (MWh)	DOWWARDS (MWh)	UPWARDS (MWh)	DOWWARDS (MWh)	UPWARDS (MWh)	DOWWARDS (MWh)
<b>ORIGINAL IMBALANCES</b>	427,14			-813,54		-489,31
<b>NETTED IMBALANCES</b>	(*)			(*)		(*)
<b>COVERED IMBALANCES</b>	281,9124			-536,94		-326,21
<b>UNCOVERED IMBALANCES</b>	145,2276			-276,60		-161,47
<b>ONE-STAGE CLEARING PROCESS</b>						
<b>SYSTEMS</b>	<b>PORTUGAL</b>		<b>SPAIN</b>		<b>FRANCE</b>	
<b>IMBALANCES</b>	UPWARDS (MWh)	DOWWARDS (MWh)	UPWARDS (MWh)	DOWWARDS (MWh)	UPWARDS (MWh)	DOWWARDS (MWh)
<b>ORIGINAL IMBALANCES</b>	427,14			-813,54		-489,31
<b>NETTED IMBALANCES</b>	-416,38			416,38		0
<b>COVERED IMBALANCES</b>	427,14			-536,94		-161,47
<b>UNCOVERED IMBALANCES</b>	0,00			-276,61		-327,84

Chart 5: Comparison between pre-netting and pricing strategies among one/two-stage

- Furthermore, when we do not apply pre-netting of imbalances and the two-stage clearing process is considered, upward/downward imbalances are handled with upward/downward resources. Given that we are dealing with a separate process for upward/downward volumes, system imbalances will only be covered with available resources so, without considering pre-netting, netting in the clearing process would not possible (\*). In this case we must consider: 1) Availability of cross-border capacities, which may provoke market splitting so that each system marginal price would differ; 2) TSOs strategies, which strongly affect the level of covered imbalances.

- When comparing two-stage/one-stage clearing processes without pre-netting imbalances, the single process provides better solutions since netting is only possible when TSOs prices and cross-border capacities allow it. The following considerations could take place when it comes to this situation:
  - If TSOs define their strategies with instrumental prices, a high level of implicitly netting could take place if cross-border capacities are available. This case could be compared with pre-netting volumes and pricing TSOs volumes. However, when pricing their imbalances with different strategies (instrumental price, probable clearing and improbable clearing), the level of netting is reduced if compared with pre-netting and pricing - competitive service providers' could reduce the level of netting, see example below.

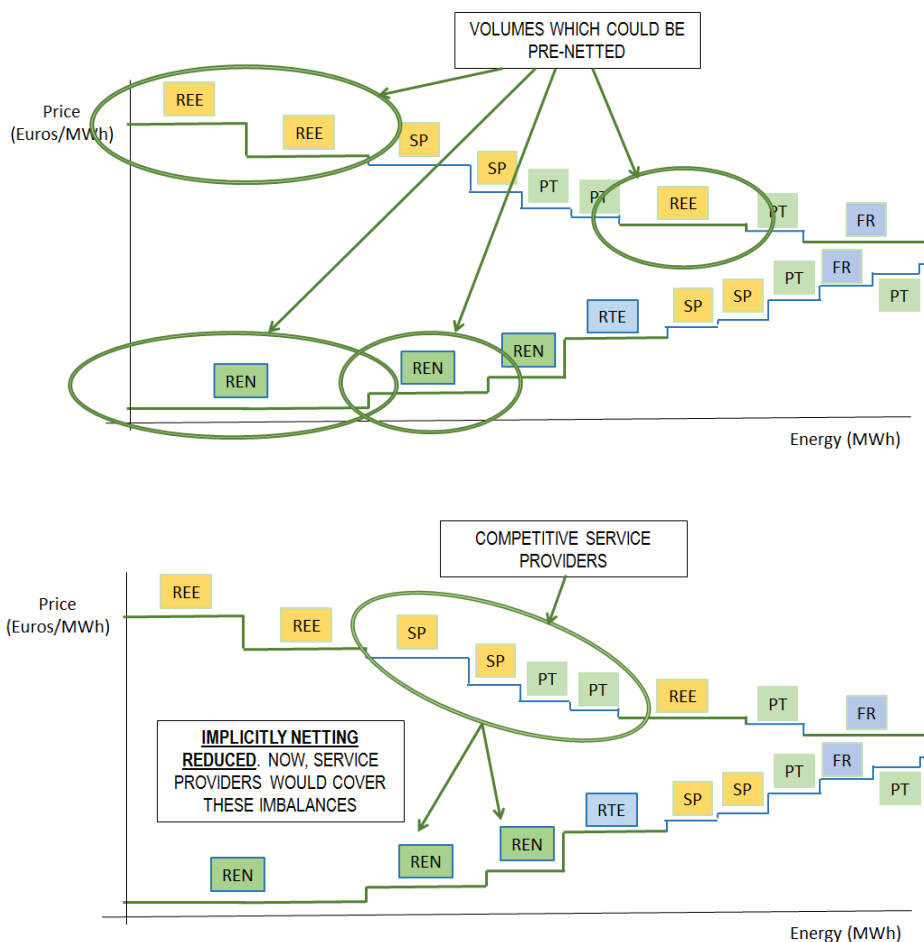

Figure 62: Reduction of netting due to competitive service providers and pricing imbalances

- This algorithm would enhance results if service providers' strategies would be different to those applied in the simulations (i.e. upward offers below day-ahead prices and downward resources below it).

Nevertheless, these strategies are only justified when offered resources correspond to technical constraints or renewable resources fluctuation, for example.

- TSOs could establish methodologies in such a way that would be willing to compensate only part of system imbalances. Thus, the key issue here is the effect of TSOs strategies on covered volumes.

In the light of that, we can acknowledge one-stage clearing process objective (optimum social welfare) but we would recommend the adoption of pre-netting independently to pricing strategies. The explanation of this fact is that pricing imbalances could prevent netting maximization, which at the end is the most cost-effective option for covering system imbalances. On the other hand, we observe that pricing only makes sense when uncovered imbalances in TERRE platform could be satisfied in latter mechanisms (mFRR), although this could be questionable. Finally, one can assume that the one-stage clearing process cannot be used when there are not cross-border exchanges and system imbalances are merely manage with isolated system imbalances.



## 5. Conclusions

The integration of European energy markets across the EU, security of supply and the Europe's aim to lead the global race with respect to a clean energy transition, have triggered the leading role of Balancing Markets. For this reason, several pilot initiatives concerning balancing products have been set up. Among them, this document focuses on the so called *Trans European Replacement Reserves* (TERRE) Project, which aims to establish a multi-TSO coordinated exchange of Replacement Reserves through a common platform, LIBRA.

This said, companies must change and forecast their strategies in order to be well-adapted under this changing environment. Consequently, forecasting tools play a key role when it comes to companies' adaptation. Regarding the aforementioned initiative, this document focuses on the development of a long-term forecasting tool based on European TERRE specifications. At this point, we can affirm that despite the high level of uncertainty in the criteria used for developing the pertinent algorithms, the model shows realistic and reasonable results from which the department may get conclusions. However, we must take into account that further changes may be applied in order to obtain a higher level of accuracy in final results.

Main difficulties during the development of the model have been mostly caused by uncertainties in the criteria selected for developing the one-stage clearing process. Thus, the reader must take into account that this document deals with a new market model and results need to be thoroughly study in order to understand new situations and problems as a consequence of its implementation.

### 5.1 Future projects

Although the new forecasting tool has implemented new TERRE specifications and it is able to provide reasonable results, the following proposals could further enhance LPRM-TERRE performance:

- On 30<sup>th</sup> June 2017 [10] has been published a new public consultation for the design of TERRE. This document gives answer to most of our questions when developing the criteria for the programming of the model. For this reason, the employed criteria must be checked and compared with the new one in order to implement changes, when considered.
- Current algorithms only consider simple offers –a set of volumes/prices–, which could be partially cleared. However, the implementation of additional bid formats (i.e. multi-part offers).
- As stated in previous sections, LPRM-TERRE model uses hourly products.

Nevertheless, European Balancing markets stand up for the usage of 15min basic balancing products and, consequently the long-term forecasting tool should be properly modified. On the other, the clearing process methodology should be as well adapted in order to represent complex offers possibilities, which may link the clearing processes in different periods within the same hour.

- Given LPRM-TERRE model adaptability for the usage of similar balancing products, current forecasting tool could be adapted to mFRR products. Thus, simulations with respect to MARI-Project could be run and analysed.

## References

- [1] “The Energy Union Package,” 2015.
- [2] E. Commission, “Energy Strategy and Energy Union,” 2017. [Online]. Available: <https://ec.europa.eu/energy/en/topics/energy-strategy-and-energy-union>.
- [3] E. Commission, “Climate Action - Decarbonising Economy.” [Online]. Available: [https://ec.europa.eu/commission/priorities/energy-union-and-climate/climate-action-decarbonising-economy\\_en](https://ec.europa.eu/commission/priorities/energy-union-and-climate/climate-action-decarbonising-economy_en).
- [4] “Integration of electricity balancing markets markets and regional procurement of balancing reserves,” 2016.
- [5] E. B. P. Projects, “Purpose of Pilot Projects,” no. February, 2014.
- [6] “The Internal Energy Market.” [Online]. Available: [http://www.europarl.europa.eu/atyourservice/en/displayFtu.html?ftuld=FTU\\_5.7.2.html](http://www.europarl.europa.eu/atyourservice/en/displayFtu.html?ftuld=FTU_5.7.2.html).
- [7] “Network Code on Electricity Balancing,” 2017.
- [8] “Directive 2009/92/EC concerning common rules for the internal market in electricity.”
- [9] *Guideline on Electricity Transmission System Operation (GL SO)*. 2016.
- [10] “Public consultation document for the design of the TERRE (Trans European Replacement Reserves Exchange),” 2017.
- [11] “Public Consultation Document for the Design of TERRE,” 2016.
- [12] “BALIT, experiences from the France-UK scheme.” 2011.
- [13] “Project Coordination Group (PCG) WS Balancing.”
- [14] “National Grid - ENTSO-E Balancing Pilot Projects.”
- [15] “Common opinion from AEEGSI, CNMC, CRE, ELCOM, ERSE and OFGEM on TERRE project design.”

## List of abbreviations

**TERRE:** Trans-European Replacement Reserves Exchanges

**TSO:** Transmission System Operator

**ENTSO-E:** European Network of Transmission System Operators for Electricity.

**ACER:** Agency for the Cooperation of Energy Regulators.

**NRAs:** National Regulatory Authorities.

**ATC:** Available Transmission Capacity

**CA:** Cooperation Agreement

**CMO:** Common Merit Order

**aFRR:** Automatic Frequency Restoration Reserve

**mFRR:** Manual Frequency Restoration Reserve

**FRR:** Frequency Restoration Reserve

**RR:** Replacement Reserves

**BSP:** Balancing Service Provider.

**GL:** Guideline

**NC:** Network Code

**EB:** Electricity Balancing

**QR:** Qualified Recommendation

**MoU:** Memorandum of Understanding

**XBID:** Cross-border Intraday

**REE:** Red Eléctrica de España

**REN:** Redes Energéticas Nacionais

**RTE:** Le Réseau de Transport d'électricité.

**SP:** Spain

**PT:** Portugal

**FR:** France

**NC EB:** Network Code on Electricity Balancing

**GL SO:** Guideline on System Operation.

**BALIT-Project:** BALancing Inter TSO Project-

**MARI-Project:** Manual Activation Resources Initiative.

**DAP:** Day-ahead price

**EFET:** European Federation of Energy Traders.

**LPB:** *Largo Plazo Banda*- Long-term (secondary regulation) Band

**LPM:** *Largo Plazo Mercado*- Long-term (Day-ahead) market

**LPR:** *Largo Plazo Restricciones*- Long-term constraints

**LPRA:** *Largo Plazo Reserva Adicional*- Long-term Additional Reserve

**LPRM:** *Largo Plazo Resto de Mercados*- Long-term other markets

**P48:** Hourly Operating Dispatch after horizon programming

**PCR:** Price Coupling of Regions

**PDBC:** *Programa Diario Base de Casación* – Base Clearing Daily Program.

**PDBF:** *Programa Diario Base de Funcionamiento* – Base Functioning Daily Program.

**PDVD:** *Programa Diario Viable Definitivo* – Final Feasible Daily Program.

**PDVP:** *Programa Diario Viable Provisional* – Provisional Feasible Daily Program.

**SSTP-AASS:** Strategic Short-Term Planning and Ancillary Services

# Annex A

Criteria (RR products only) <sup>8</sup>	TERRE RR product	REE	Swissgrid	Terna	RTE	REN <sup>9</sup>	National grid
Preparation Period	from 0 to 30 min	0-30 min	Upwards: 0-15 min Downwards: 0-15/20 min	0-30 min	0-30 min	0-30 min	Related to the technical data
Ramping Period	from 0 to 30 min	0-30 min	Upwards: 0-15 min Downwards: 0-15/20 min	0-30 min	0-30 min	0-30 min	Related to the technical data
FAT	30 min	30 min	Upwards: 15 min Downwards: 15/20 min	30 min	30 min	30 min	Related to the technical data
Minimum and maximum quantity	Minimum 1MW	"Minimum offer 1 MW Minimum for prequalification: 10MW no maximum"	Minimum: 5MW Maximum: 100MW	up to 0	Minimum : 10 MW (1 MW limited) Maximum : 9999 MW	Minimum 0,1 MW	3MW
Deactivation Period	same as the ramping period	N/A	0	Related to the technical data	N/A	Related to the technical data	Related to the technical data
Price of the bid	the Cap & Floor prices will be compliant with the local market rules	No cap, and floor = 0 €/MWh	Upwards: 0 to 9999€/MWh Downwards:-500 to 3000€/MWh	No negative bids are allowed	Upwards: 0 to 9999 €/MWh Downward: -9999 to 9999 €/MWh	No cap, and floor = 0 €/MWh	Upwards: 0 to 9999 €/MWh Downward: -9999 to 9999 €/MWh
Divisibility	Under the responsibility of BSP Min volume = 1MW Resolution = 0,1MW Maximum Bid Size: in case of divisible bid, no max is requested	There is a possibility to offer 1 indivisible block per bid (the cheapest one)	No (only block offers)	Related to the technical data	Related to the technical data	Related to the technical data	Related to the technical data
Min delivery period	15 min or multiples of 15 min	1h	15 min	1h	Up to the BSP	1h	30 min or multiples of 30 mins
Max delivery period	60 min	4h (between ID sessions)	4h	24h	Up to the BSP	1h	Up to the BSP
Validity Period	defined by BSP but equal or less than 60 min	Between 1h and 4h	4h	From 1h to 24h	Between 4 and 6 hours	Between 1h and 4h	Defined by BSP, minimum of 30 mins
Mode of Activation	Scheduled	Scheduled	Direct activation	Scheduled	Direct activation	Scheduled	Direct activation
Minimum duration between the end of Deactivation Period and the following activation.(Recovery period)	defined by BSP	N/A	0	communicated by the BSP	Communicated by the BSP	N/A	Defined by the BSP
Location	Bidding zone	Yes. Physical location of the BSP is known (Unit Based)	Bidding zone	Bidding zone	Unit or aggregate	Physical location of the BSP is known (Unit Based or aggregate)	Physical location of the BSO is known (Unit Based)

Figure 63: Comparison among TERRE product and current local RR products