



UNIVERSIDAD PONTIFICIA COMILLAS

ESCUELA TÉCNICA SUPERIOR DE INGENIERÍA (ICAI)

En

MÁSTER OFICIAL EN EL SECTOR ELÉCTRICO

TESIS DE MÁSTER

**Assessments and Recommendations for
Regulatory Framework in Overcoming the
Barriers of Integration Distributed Generation in
Smart Grid Process**

By

Osta Melva Romauli Siahaan

For Master EMIN Program

Madrid, February 2014



Autorizada la entrega de la tesis de master del alumno/a:
Osta Melva RomauliSiahaan

.....

EL DIRECTOR
David Trebolle

Fdo.: Fecha://

Vº Bº del Coordinador de Tesis
Javier García González

Fdo.: Fecha://

Acknowledgements

Finally after the opportunity to dig my knowledge about economic and management industry I reach the last stage of my Master degree by finishing this master dissertation. In order to finish this last step of the Erasmus Mundus Joint Master on Economics and Management of Network Industries, I have received a lot of support that I would like to mention here :

First of all, thank you for Jesus Christ, my Lord and my saviour who always accompanies me during my study in Europe especially during difficult time in last chapter of this master program. Thank you for listening to all my prayers.

My supervisor, David Trebolle, I really am thankful for your guide and dedication and your quick response during my thesis. It is an honour for me to know someone who is very respected in this distribution sector. Thank you for all your idea, knowledge and information, so finally my master dissertation.

The EMIN team, Javier Garcia González, Andrés González, Sara Tamarit, Yannick Perez and MakaTraore, thanks for the opportunity to be part of this master and for the excellent support I received in the last two and half years.

My beloved family who always support me from Indonesia, especially my Mom, who never stops to pray for me, I thank you Mom, for all your understanding. To NicoWieknyoputra, thank you for accompanying me during the hardest time in finishing this thesis, and always be a good listener.

My EMIN friends, I felt that I am so lucky to have the friendship with all of you guys, especially for those who were with me since Paris. You are such a good friend. My other international friends that I met in Paris or in Madrid, I am thankful for all the chance to meet you, so I could open my mind and even exchange culture differences.

Finally, I would like to thank my Indonesian friends, who have come to my life in Europe within the last two and half years Either you are bad or good person, I believe that God sent each of you to enrich my life eventually.

INDEX

INDEX.....	4
Abbreviations:.....	6
List of Figures	8
Abstract	10
I. Introduction, motivation and objectives.....	11
II. The Smart grid process.....	16
II.1 The need for a Smart grid	16
II.2 Definition of Smart grid Process	18
II.3The Distributed Energy Resources Challenge	20
III. Distribution Generation.....	30
III.1 Definition	30
III.2 Types of technology.....	33
III.3 Generation and capacity figures	44
IV. Current barriers to the DG integration.....	53
IV.1 Market access and Incentive Scheme for DGs	57
IV.1.1 Why DG is not yet profitable yet?	57
IV.1.2 How are we are going to open ways to this market access issues?	63
IV.1.3 The Challenge of Prioritization Access for Support Scheme	70
IV.2 Connection and Access to the Distribution Grid (Technical Constraints).....	70
IV.2.1 Connection	71
IV.2.2 Access	72
IV.2.3 Non-firm (interruptible) connections versus firm connections.....	73
IV.3 Lack of Participation in Distributed System Services	84
IV.3.1 What is System Service?	84
IV.3.2 DSO Main Business Process	85
IV.3.3 Why System Services?	101
V. Regulatory recommendations	103

V.1 Recommendation for Market Access and Incentives Schemes for DG:.....	103
V.2 Recommendation for Connection and Access Challenges:.....	108
V.3 Recommendation Lack of Participation in Distributed System Services	110
VI. Conclusion	136
Bibliography	139
Annex 1 The Benefit of DG	145

Abbreviations:

AMI	Advanced Metering Infrastructure
CHP	Combined Heat Power
DER	Distributed Energy Resource
DG	Distributed Generation
DSO	Distribution System Operator
EU	European Union
ENTSO-E	European Network of Transmission System Operators for Electricity
EV	Electric Vehicle
FIT	Feed In Tariff
GW	Giga Watt
GWh	Giga Watt hour
GWP	Giga Watt Power
HW	High Voltage
ICT	Information and Communication Technologies
IEA	International Energy Agency
KW	Kilo Watt
LV	Low Voltage
MCFC	Molten Carbonates

MV	Medium Voltage
MW	Mega Watt
OECD	OECD (Organization for Economic Co-operation and Development)
O&M	Operation and Maintenance
OoS	Out of Step
OTC	Over The Counter
PAFC	Phosphoric Acid Fuel Cell Plant
PEMFC	Proton-Exchange Membrane
RES	Renewable Resources
SAIDI	Average duration of interruptions per customer per year
SAIFI	Average number of interruptions per customer per year
SOFC	Solid Oxide
SoS	System Observation Service
TSO	Transmission System Operator

List of Figures

Figure 1 Physical and Commodity Subsystem for Electricity Supply Sector	13
Figure 2 Today's Electricity Grid	18
Figure 3 Smart Grid – The Grid of the Future	18
Figure 4 The Voltage Level for DG or RES, Eurelectric	31
Figure 5 Distributed Generation in an Electricity Network	32
Figure 6 Reciprocating Engines	34
Figure 7 Gas Turbines	35
Figure 8 Micro Turbines	37
Figure 9 Fuel Cell	38
Figure 10 Photovoltaic System	40
Figure 11 Wind Farms	42
Figure 12 General Summarise of DG	43
Figure 13 Installed Capacity (in MW) for DG and renewable	44
Figure 14 Installed Capacity (in MW) for DG and renewable	45
Figure 15 Cumulative Market Share and Installed Capacity share in EU, in 2011	46
Figure 16 Electricity Generation Shares in the EU27 Countries	47
Figure 17 Installed Capacity Shares in the EU-27	48
Figure 18 RES and DG in Europe	48
Figure 19 Annual Renewal Distributed Energy Generation Installed Capacity by Region, World Market 2011 and 2012	49
Figure 20 Distributed Generation Installed Capacity and Peak Demand in Galicia, Spain	50
Figure 21 Installed Capacity of Photovoltaic Installations in the E.ON Bayern Grid (Source : E.ON ..	51
Figure 22 Installed Electricity Capacity in Central America	52
Figure 23 Wind Power Production (2400 MW Wind Power) and Load in Western Denmark	53
Figure 24 Impacts of wind power on power systems divided into different time scales	55
Figure 25 New DG technology learning curve transformation in terms of cost, performance and time scale	59
Figure 26 Cost Comparison between DG technologies	62
Figure 27 System Specific Cost Timeline	65
Figure 28 Overview of Support Schemes (Investment and Operating Support)	67

Figure 29 Power Flows Between Transmission and Distribution Network in Italy, 2000-2012 taken from EnelDistribuzione.....	76
Figure 30 Description about Voltage Control in Current Distribution Network	78
Figure 31 Relation Between The Degree of DG Penetration and Grid Losses	82
Figure 32 Distribution Network in most European Union Members	94
Figure 33 comparison the design of the Distribution Network with Less DG penetration and with today's condition	99
Figure 34 Proposing Decreasing of Support Scheme Through Times.....	105
Figure 35 Three-Step Evolution of Distribution Systems	111
Figure 36 The Capacity Evolution of DSO in Business from Yesterday, Today an Tomorrow's plan	113
Figure 37 Arrangements between DSOs and Suppliers	115
Figure 38 DSO interaction with TSO through several time frame	116
Figure 39: Market and Network Operations	123
Figure 40 Traffic Light Scheme	126
Figure 41 :Inital investment in Nuclear existing plants in France	147
Figure 42Inital investment in Small Distributed Capacity Investment	148
Figure 43 Public Markets and Asset Finance Investment in Renewable Energy in the US by sector	149

Abstract

In most places in the world, the electricity is generated in large generating stations. The electricity that is produced, is transmitted through high-voltage transmission system, and then will be transmitted to the consumers through local distributed systems at reduced voltage. Distributed Generation (DG) change the process of transmission by producing the electricity on a customer's site or at local distribution utility and supply power directly to the local distribution network. Many factors and conditions support the growth of DG which makes them having an important role in the electricity system transformation today.

Moreover, since the conception of renewable energy, the DG becomes one of most the happening today. A new reform in power sector could be achieved by gaining the advantage of this type of generation. However, the development of this generation is not easy because there some issues in certain countries like from the economic side, technical problems, and commercial issues regarding this new concept in the electricity. Which in turn, the electricity regulatory framework in the world does not support the penetration of DGs and it become obstacles to DG to have position in the electricity market. Those policies made can include unfavourable regimes for network access and market access, lack of transparency and the biggest obstacle is the overall structure of the electricity market itself.

The transformation in power sector itself incurs the development of Smart Grid in the electricity network and moreover the growth of DG to expand the renewable energy. The transformation of electricity by having new generators both in numbers and capacity are being connected to distribution networks, which will be continuously trending in the coming years. Nevertheless the expansion of the DG introduces new challenges to ensure the reliability and quality of power supply. Those distributed energy generations make an effort in certain direction to unpredictable network flows, greater variations in voltage and different network reactive power characteristics. More often local grid constraints come up which negatively have impact to the quality of supply.

This situation substantially will give impact to the distributed system operators which generally designed and operated distributed networks through a top-down approach. Generally in the centralized generation, predictable current did not need intense management and monitoring tools. Because of the transformation in electricity, this model is changing. DSO is expected to have extra roles to continue to operate their networks in a secure way and to provide high-quality service to their customers.

Key words : Distributed Generation, Smart Grid, Regulatory Framework, Distribution Network, Renewable Energy.

I. Introduction, motivation and objectives

Information and communication technology are used by Smart Grid system as a new system that gather and act automatically on information about the behaviours of suppliers and consumers in automatically to improve the efficiency economics, reliability economics and sustainability of the production and distribution of electricity. Smart Grid can bring solution to grid balance issue, as nuclear energy provides large amount of schedulable electricity while renewable energies are intermittent.

From those variant resources of electricity supply, the electricity system needs more accurate way in order to make sure the electricity supply will meet the demand from the customer. The characteristic of electricity as a commodity is it has to be used the moment it is generated, and therefore the grid represents the ultimate in just-in time product delivery. This situation requires every party involves in this system has to work almost perfectly at all time and does.

In order to connect new and more massive electricity injection points, there are transformation in grid pattern redesign and new lines construction. Furthermore, Smart Grid implementation is triggered by a higher renewable share in the electricity generation mix. The increasing of electricity usage requires more information about the demand so that the supply could fulfil the need of electricity more accurately. Developing intelligent networks of smart grid will enable the implementation of demand-side participation which enables a prediction of behaviour the demand usage by using Advanced Metering Infrastructure (AMI). Accuracy of demand prediction is really important in stability of electricity system. From the demand side, customer will be able to manage and adjust their consumption such as energy savings, energy shifting, and peak savings in order to respond to real time information and dynamic price signals. It is expected that the demand for electricity to increase by 1-2% per year. The future customer will tend to shift their consumption of electricity to be more efficient energy sources in sectors such as heating & cooling and transport.

In liberalization market, this accuracy is really important in the supply side of electricity due to the assuring the security and quality of supply especially after the increasing of number of

players in the generation side that offer not only centralized generation but also DG. Huge growth of energy generation through decentralized renewable source (RES) promised new energy resources that affect the existing electricity system. To achieve sustainability, competitiveness and security of supply, in electricity energy RES from DG are considered as a key elements that meet that objectives. Penetration of RES helps countries that have climate and energy targets in terms of its power sector which is striving to achieve a carbon neutral power supply system. Especially the share of electricity supply from RES will rise in the coming days especially for those countries who have to meet the target for RES in total energy consumption like European Union (EU) with its 2020 program (Eurelectric, (Halberg, Claxton, et al. n.d.)).

Unfortunately at this moment, most of the DG are not economically viable yet compare to centralized existing generators. In the difficult economic situation this DGs penetration especially those that are used RES resources cannot be a favourable choice new generation plants because in most countries they are still in the process of positioning in the market. In some countries there is a consideration that RES contributes to increase in electricity prices linked to the replacement of relatively cheap nuclear electricity by other more costly electricity sources;

Not to mention, this new technology needs support not only economically but also technically from the players of the electricity system. Interactions between DG, renewable operators, Distribution System Operators (DSOs) and the electricity markets have been changing because of the increasing of electricity source from DG and RES lately. The variation of technologies use in RES which will be connected in the existing or future distribution system will contribute additional variable to the electricity system that will ask more flexibility from supply to demand in the network infrastructure.

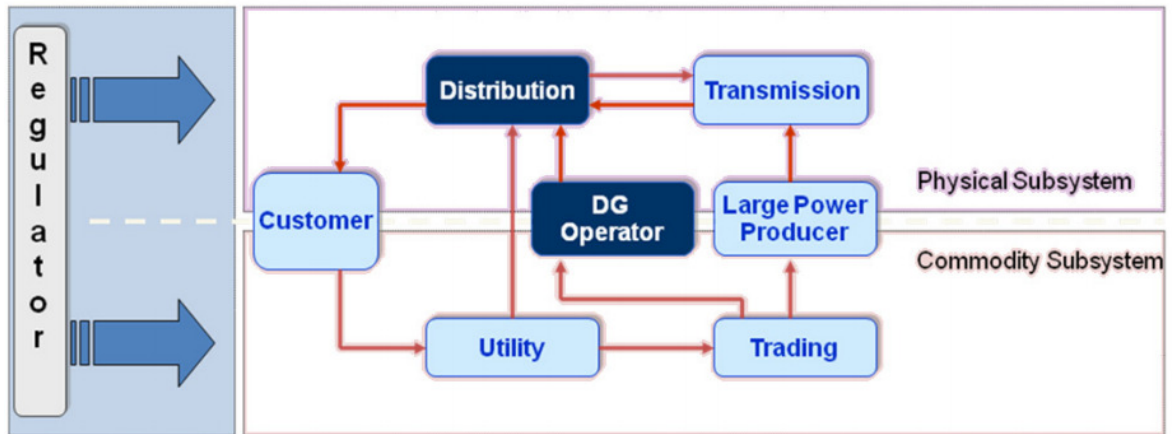

Physical and commodity subsystem for electricity supply sector

Figure 1 Physical and Commodity Subsystem for Electricity Supply Sector

Source (Cali, Ropenus and Schroder 2009)

During its development from time to time, DG so far has been passing three series of reform which are independent power producers and the second generation introduced wholesale and retail competition. The latest one is when decentralised generation individuals units are deployed at or nearer customer's sites and the DSO. DG still needs a support in order to keep on its penetration. There are three major existing barriers in order to implement the DG, which are lack of incentives for the DSO, connection charges and access to balancing. There is a lack of incentive for the DSO regarding the lack of incentive. Many national legal regimes still do not include any explicit incentive schemes for DSOs to connect DG units to their grids (Skytte and Ropenus 2005). DSOs do not treat DG as an active control element in the operation and planning of their network. In some areas in the world treat DG as an additional complexity and thus fear additional cost like in the EU.

Harmonization of transmission pricing and regulation are some issues in the electricity liberalization market, which happens in some of EU member states. Unfortunately, its liberalisation and internationalisation electricity market do not make initiative in order to consider the opening up and regulation of distribution networks to make sure effective participation of RES and DG in the internal market.

Regulatory and market environment should take part in this process of transformation by impose a general condition for those players involve in it. The regulator represents the relevant legislation that could be different party in any country. Market design and regulation impact the incentives of different market actors, for example DG operators, large power producers, customers, TSO (Transmission System Operator) and DSOs and how they are intertwined. (Cali, Ropenus and Schroder 2009).

Motivational Question

The motivation of this thesis is to assess and analyze the regulatory framework in order to improve the interface between DG and the electricity supply system for promoting the deployment of RES/CHP (Combined Heat Power) through the development of regulator guidelines. By finding out and analyzethe obstacles either from technical or regulation side that hold up the integration of DG in electricity system, this thesis will try to analyzewhat recommendation and suggestion should be given to regulatory actions which are needed to support the integrationof DG?

Those challenges faced by DG as the happening technology right, would be specifically, we be analyzed in terms of these problems:

1) Regarding the market access and incentive scheme for DGs

Because of the DG's shares are increasing the electricity system, either from CHP or from RES during the last decades, the interactions between DG/RES operators, DSOs and the electricity markets have been changing. Unfortunately since it is still a new concept of technology compare to centralized generations which are already the incumbent players, DGs face some challenges regarding the market access and incentive scheme in order to put position in the electricity market. Those problems are going to be elaborated in this Master Thesis.

2) Facing the connection and access challenges in distribution grid

Just like other generation in the electricity system, DGs who were asked to be connected and access the grid must obey the obligation either financially or technically. The challenges incur in term of the distribution grid are not designed to accept numerous number of DG connection. Not to mention, the intermittent RES that have to be treated differently

regarding its technically, and some other challenges that will be explained in this thesis regarding connection and access.

3) Lacking of participation in distribution system services.

As a network operator in the distribution grid, DSO has limitation of authority comparing to authorities of TSO in the transportation system. This limitation will bring challenges in terms handling the problem in the distribution grid as the increasing of penetration of DGs in the distribution network. This thesis will elucidate the challenges will face in the distribution network in order make sure the stability of electricity system, even though the integration of DG are increasing through time.

II. The Smart grid process

II.1 The need for a Smart grid

The specific characteristic of electricity is it has to be used the moment it is generated, and the electricity grid represents the ultimate in just-in-time product delivery. In electricity system, everything must work almost perfectly at all times due to this characteristic. But as the need of electricity grows rapidly through over the world, especially to those countries that have massive economic growth, the needs of electricity increase rapidly. The electric distribution network will have to respond to the challenge that the consumer will increase their electricity usage as they make wider use of this energy such as plugged-in hybrid vehicles, air, and ground sourced heat pumps and air conditioning.

The rapid growth of electricity usage because of the economic development has led to need of increasing the electricity supply. The increasing of electricity supply is the consequences of more available variants of generators either form fossil fuel, nuclear, or RES. This situation makes the need of expanding transmission electricity from the generators to the end customer. Based on this fact, the overburdened grids in some countries have begun to fail more frequently and incur those countries with substantial risks.

Unfortunately, as time goes by, the cost of construction of transmission increased too, especially in congested or public pressure areas. This circumstance leads to pressure to find smarter solution in order to use existing resources, through a bundle ways of innovation which known as the Smart Grid. The notion of the innovation involved in several requirements such as :

- a) Innovation in terms of metering that is more sophisticated by allowing time-of use and two-way metering of electricity flows
- b) Innovation in term of communication networks which enable two-way flow of information between producers, consumers, and electricity system operators
- c) Innovation in appliances and devices which have capability in responding autonomously to price signals or instructions from the network operator.

This solution has a transforming role that not only to bring more efficient way to distribute and diversify power sources, invent ability to make the grid more efficient by reducing demand peaks and increasing capacity utilization, but also offering consumers with innovative tools to decrease energy usage, which eventually making them save money. This situation is possible because Smart Grid is one way of integrating the amounts of decentralised generation, electric vehicles and heat pumps into the network and encourages consumers to actively manage their energy demand. Comparing the Figure 2 and Figure3 we can see briefly the difference between the conventional grid and the Smart Grid one. There are some developments in Smart Grid technology that require additional investment in new infrastructure.

In the new process of Smart Grid, eventually customer will have economic signal of their energy consumption and know how to manage their electricity usage. They will be able to manage and adjust their electricity consumption in response to real time information and changing price signals (Eurelectric,(Halberg, Claxton, et al. n.d.)). In order to support these changes of customer behaviour in the demand side the electric system needs to adjust to them. The suppliers have to design a dynamic feedback programmes that provide them with the information of the supply side of electricity in order to make the customer being actively manage their consumption. The supplier needs to integrate with advanced intelligence to provide necessary information which eventually optimize electric services and empower customers to decide energy resources to be used.

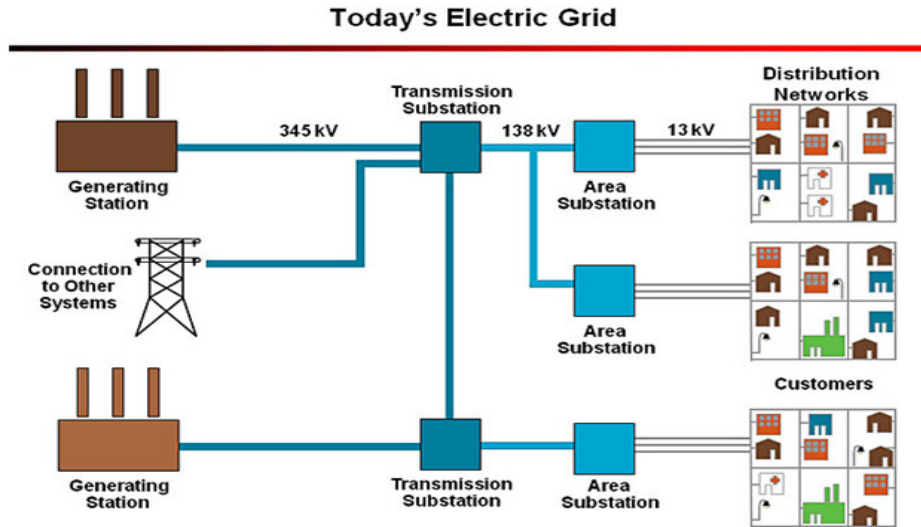

Figure 2 Today's Electricity Grid

Source : (Perlman 2009)

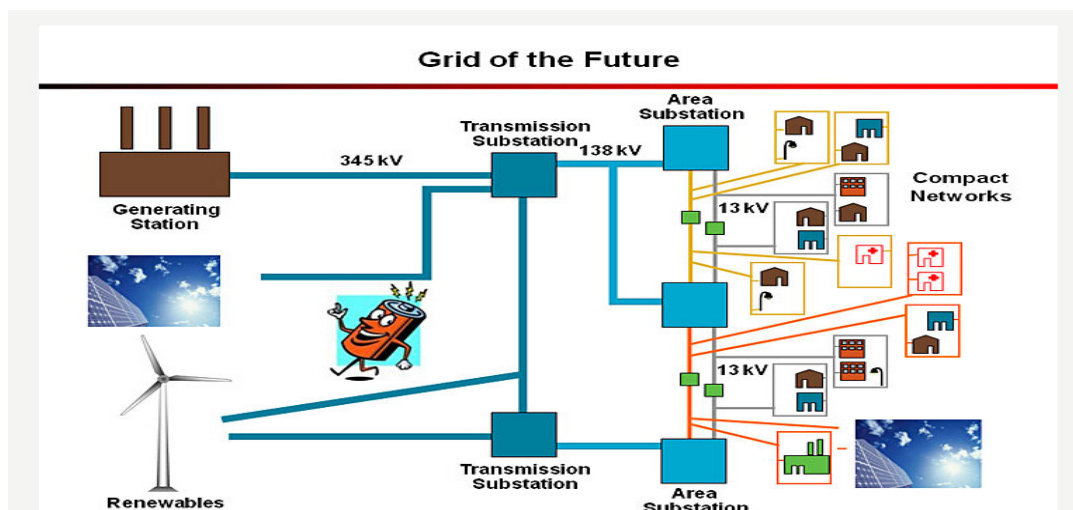

Figure 3 Smart Grid – The Grid of the Future

Source : (Perlman 2009)

II.2 Definition of Smart grid Process

As mentioned before, the concept of Smart Grid is not rolled out in a single swoop on the contrary is a process that the implementation is an incremental and continuous step-by-step learning

process, which characterized by different starting points in different region. In Europe the Smart Grid standardization is an indispensable step in order to make sure Smart Grid deployment. In different areas there is multitude of standards which are required to ensure new functions and interoperability.

In the European Union, there are four main areas benefit promised by the Smart Grid process:

- 1) Smarter Network management
- 2) Demand-Side Participation
- 3) Decentralized Storage
- 4) Aggregation and Management of RES DG

There is a possibility of more interaction between the actors in electricity system because of Smart Grid. In this interaction, there are not only new opportunities but also challenges. Those actors from generators until the end consumer will benefit from the additional functionalities and process offered from smart grid. On the contrary, there will be challenges occur to those actors, which need to be managed majorly by the grid operators, yet the support and commitment from other participants are needed.

Based on the European Union understanding Smart Grid is defined as a process and it is not a onetime process it is a step-by-step process or an evolutionary process, which will develop over time. It is a process that is expected to provide cost-efficient solutions for market actors by enabling interoperability, avoiding the high compliance cost by diverging national approaches. As a new concept of electricity network, Smart Grid is able to integrate efficiently the behavior and actions of all electricity actors who are connected to it, from generators, transmission, distribution until the end of electricity user, an eventually Smart Grid will make sure an economically efficient, sustainable power system with low losses and high quality and security of supply and safety. This evolution process will cover not only the grid but also all the electricity users linked to it, from either technical or not technical building blocks in order to deliver electricity efficiently, reliability and securely by using information technology in order to support the transformation process.

The Smart Grid process employs innovative products and services together with intelligent monitoring, control, communication and self healing technologies for providing:

- a) Better facilitation the connection and operation of generators of all sizes and technologies
- b) Possibility of electricity end user to play a part in optimizing the operation of the system
- c) Greater information and possibility of choosing the supplier for electricity end user
- d) Reducing the environmental impact of the whole electricity supply system
- e) Enhancing level of reliability and security of supply delivery

Given the complexity of Smart Grids and its incremental nature, a one-size-fits-all approach to its development will not deliver. (RODRIGUES DA COSTA, et al. 2011). For example in the European Union region, because of the width area, every development of Smart Grid in each country will be adjusted based on local needs. This Smart Grid process is a nationwide planned in each Member States of European Union.

II.3 The Distributed Energy Resources Challenge

The vision for the integration of distributed energy resource is a smart grid platform that would link a system of diverse generation sources, including a variety of fossil fuel and renewable and distributed sources, across the grid to a large set of consumers with possibilities for improved energy efficiency, local generation, controllable loads or storage device. (Karkkainen n.d.). Large-scale deployment of energy alternatives, (especially from RES ones) promised potential of substantially contributing to the enhancement in the energy policy in most liberalization market which is competitiveness, sustainability, and security of supply.

There are four Distributed Energy which have their own challenges in terms being integrated in the distribution grid :

1) Electrical Vehicles (EVs)

EVs could have a disruptive impact in the electric grid unless they are integrated carefully. In order to gain the energy to run electrical vehicles, they need to connect to the distribution network to be recharged. Some of them are going to represent a larger load than a house. The degree and density of their penetration, charging requirements, and the time of day they are charged, are the factors that will determine the degree of their impact to the distribution grid. There are certain levels in terms of charging EV in the distribution grid, for

examples in the US there are Level I (up to 1.92kW (kilo Watt)), Level II (up to 19.2 KW) and level II which has not been standardized yet in this country. Normally the EV owners are going to charge their EV as soon as they arrive at their homes each day, which as the same time as neighborhood load peaks since the electric rates varies over time especially in the liberalized market. This circumstance will aggravate local peak load conditions which push utilities to invest in expanded infrastructure because peak charging leads to higher charger power ratings and escalate the number of EVs on transformer and brings about decreasing in transformer lifetimes as the result of temperature-induced insulation aging from capacity overload.

Concept of Vehicle-to-grid operation was introduced in order to suggest the flow of energy between the power system and EVs may be made bidirectional. The general notion is various types of operating reserves could be provided by storing energy in EV. It is expected in the liberalized wholesale market that by supply energy to the distribution grid, EV could take a part in frequency regulation or other reserve market.

The technical challenges about this concept are :

1. Investment in substantial and expensive modifications to conventional unidirectional vehicle chargers and controls
2. Regarding the technical issues are : degradation of battery life, problems about Original Equipment Manufacturer, Additional cost of control and communication with the utility companies,

From the economic side, currently the economic incentives for Vehicle to Grid Operation Concept are still not “promising” due to low price paid to participants for regulation service. Furthermore the participation of EVs in these markets tends to make the prices to decline.

2) Demand Side Management

While supply and demand is a bedrock concept in virtually all other industries, it is one with which the current grid struggles probably because, as noted, electricity must be consumed the moments it is generated. Without being able to ascertain demand precisely, at a given time, having the right supply available to deal with every contingency is problematic at best. This is particularly true during episodes of peak demand, those times of greatest need for electricity during a particular period.

In certain areas in the world, the customer preference and household electricity consumption have different pattern, consequently the demand response at the household level will also different. For example in Europe in some countries such as Sweden and Finland for instance, the average yearly household consumption is three times higher than in Southern Europe (around 15.000 kWh compared to less than 5.000 kWh) (Eurelectric(Halberg, Claxton, et al. n.d.)).

But average consumption is not the only factor specify the potential for demand response. The share of usage which can be shifted would likely be the most important one of the demand response concept. Innovative demand response products packaged by suppliers will deliver-given market reflective- end user prices-powerful message to consumer about the value of shifting their electricity consumption (Eurelectric(Halberg, Claxton, et al. n.d.)).

Some of challenges in terms applying this concept of Demand Side Management:

- 1) From the technical side is the lacking of manufactures of energy efficient technologies in order to support this program. Research and developments are needed in order to overcome these constraints. Moreover the energy efficiency goal as one of the goals of DSM, has limitation of technical expertise.
- 2) Lacking of awareness of energy efficiency and DSM programmes especially in the developing countries, and for that reason marketing is needed in order to promote them.
- 3) In terms of energy audits in order to gather reliable information on industrial and commercial companies, has not been done in their current operations
- 4) Proper financial analysis of the benefits of energy efficiency improvement must be carried out by emphasising not only the initial cost of equipment used for this programmes but also on life cycle costs. Because there is perception that electrical energy is not a big chunk of overall cost, and consequently little motivation incurs in terms of paying for DSM measures to modify load profiles
- 5) Due to its new concept DSM still need competent evaluation in order to find fund for its project because as part of the procedure of finding funds for DSM projects, all investments need to be justified. The resources of the fund can be from internal

resources, banks, or other funding institutes such as international cooperation agencies and the World Bank.

3) Storage

In EU region, every member states must obey 2020 target, and energy storage is going to play a key role in supporting that target as a low-carbon electricity system. As RES becomes the favorite energy resources compare to fuel resources, but, the solution about the issue of its intermittent criteria is has not been solved. In order to overcome this barrier, energy storage has ability in order to supply more flexibility and balancing to the grid, providing a back-up to intermittent renewable energy. Management of distribution networks, costs reduction, and efficiency improvement are some benefits can be fulfilled by using energy storage locally. This situation can lead to RES introduction to the electricity market, accelerating the decarbonization of the electricity grid, enhancing the security and efficiency of electricity transmission and distribution (by enabling reduction unplanned loop flows, grid congestion, voltage and frequency variations), stabilization electricity market prices, making sure better security of energy supply. Electricity storage is really useful in order to backup the forecast error of demand, like in Germany a study revealed that a one hour error on the forecast of upcoming wind creates electricity need about 5 GW (Giga Watt) to 7 GW. By having the electricity storage, this kind of problem can be anticipated.

Intermittency from the RES , will not bring any problem if it is lower than 15% to 20% of the overall electricity consumption since the grid operators can compensate the intermittency. Unfortunately, in some countries that are focusing on their RES technology such as Denmark, Spain and Germany, most of the case the share of it exceeds 20-25%. In the case intermittency above 25%, curtailment in the electricity must be done in order to avoid grid perturbation like frequency, voltage, reactive power and grid congestion. The other alternative for the last case, the RES excess should be stored.

Although with some promising benefits there are some barriers for storage :

- 1) From the side technical, because it is still new concept of technology too, it is still enhancement of its capacities and efficiencies of the current technology, and new

technology development for local (domestic), decentralized or large centralized application, and deployment of the market

2) Regarding the issue of the market and regulatory

Investment should be done in order to build storage capacity and provision of storage services. By doing an appropriate market signals can be created. Moreover the general balancing market should be done to support storage entering the electricity market.

3) Future strategic plan

Storage will need integration approach in order to embrace the storage itself, technical, regulatory, market and political aspects.

4) From the economic part

The regulation should arrange the compensation schemes for every involvement in this new technology concept from the regulated market (TSO or DS) and other deregulated market part such as producers and customers. Service that needed for the storage should be as economical as possible for example a provision single service is not suitable in both Europe and US to reach cost storage scheme cost effective; meanwhile frequency stabilization and voltage stabilization are service that can promise higher commercial value. The owner of the storage itself should be decided whether it should be owned by TSO or DSO, or even utilities companies

5) Grid integration issues

In order to improve the grid flexibility, energy storage should not be associated as a stand-alone technology. Based on this situation, the system will need a whole package of integrated measures such as large centralized and small decentralized storage along with flexible generation systems either centralized or decentralized, and also back up capacity.

4) Distributed Generation

As the main topic that will be discussed in this thesis DG have its certain challenges compare the three of Distribution Energy Resources mentioned above. Due to the configuration of power lines and protective relaying in most existing distribution system was based on unidirectional power flow and moreover are designed and operated according to that assuming, nowadays the integration of DG incurs new challenges for distribution system

planning and operation. Nowadays, generally the distribution network are designed using a fit and forget approach which makes a setting for protection equipment remain static. Detection of a fault that happens in the distribution network because of DG units and the coordination among protection devices could be hard to be done because they can increase current at a fault and reduce it at the protection device for the time before the DGs detect the fault and disconnects. Moreover, the network in which DG units are connected and operated at any period will assign faults current at point of system protection. Unreliable operation of protecting equipments could be incurred as the result of changing fault currents with the introduction of DGs which leads to faults propagating beyond the first level of protection. This situation will reduce electricity system reliability and safety as the propagation of faults through system protection layers continues.

If sited optimally from a power system point of view, DG or RES facilities may induce reduction in line losses, substitute network upgrades at the distribution and transmission level, provide congestion relief and contribute to network reliability and power quality through the provision of ancillary services. (Cali, Ropenus and Schroder 2009). Increasing their penetration in the electricity market stimulates competition, technological progress and innovation. Furthermore, DG or RES also deliver environmental friendly electricity energy resources. Those positive influences catalyze the growth of DG.

In terms of supporting the penetration of DG, Smart Grid has important role because Smart Grid can permit the penetration of DG more easily. The ability of Smart Grid in order to improve the capacity of electricity networks especially for those DG with RES technologies that are variable in output because:

- a) Smart Grid is able to do real time price differentiation over time and location, in order to incentivize customer reduction of demand or shift the electricity time of use
- b) It helps in terms of remote control the electrical devices, which enable consumers or electricity suppliers to abridge or change their time of use in order to response to market signals
- c) Support the injection of electricity into the grid by either consumers or embedded producers, such as from small-scale wind or solar generation.

- d) Endorse real-time billing and payment mechanisms that are able to keep track time of use and production of electricity over time, moreover allow this situation to be communicated remotely
- e) In supporting the DG penetration, Smart Grid is able to track both customer draw of electricity from the grid and customer input into the grid from customer-owned generation.

The reason behind the recent revival of DG is two-fold: the liberalization of the electricity markets and concerns over greenhouse gas emission. (Martin 2009). After the deregulation process in EU in the electricity and gas, the two directives (Directive 96/92/EC and 98/30/EC) incurred a new framework to make possible situation for DG to increase their share in the total electricity generation mix. The effects of this deregulation are:

- a) There are reduction of some barriers to entry for DG

DG was able to move in niche markets and join the lack of benefit that centralized generations did not offer. These new applications took the form of standby capacity generators, peaking generators (i.e producing electricity only in case of high price and consumption periods), generators improving reliability and power capacities, generators providing a cheaper alternative to network use or expansion, provision of grid support (i.e provision of ancillary services permitting better and safer operation of the network and/or shortening the recovery time) (Martin 2009)

- b) The Introduction of price premium

There was price premium benefit launched for DG due to its smaller size and quicker to build technology compare to centralized generation. DGs are able to set up in congested areas or use it only during consumption peaks because of its geographical and operational flexibility. Besides, for small excess demand, it is often uneconomical to build an additional centralized plant whereas with lower capital expenditure and capacities, DGs might come in handy. (Martin 2009)

- c) The environmental constraints

These were the second booster the expanding of DG especially for those DGs that uses RES as their energy resources. Cleaner and more efficient use of energy are the needs for the environmental and economic constraints.

Unfortunately like most of the new technology, the penetration of DG is not as smooth as it was expected. Some aspects in electricity sectors need to be modified in order they have the sustainable forecast penetration of DG. One of the aspects is the architecture of electricity market. Originally, the existing infrastructure of electricity was not originally built to accommodate a large proportion of DG. Recently the economic crises that happen in some countries in European Union affect the penetration of DGS. In fact, only sufficient adjustments are implemented in order to accommodate new capacities of DG.

Over the long run, however, increasing significantly the share of DG will necessarily mean revamping the whole physical and regulatory architecture of the electricity network and more precisely the distribution network. (Martin 2009)

For DG/RES to deliver their envisaged benefits however, the realisation of physical infrastructures alone will not be sufficient and must be complemented by the emergence of new business models and practices, new regulations, as well as more intangible elements such as changes to consumer behaviour and social acceptance. (Giordano, et al. 2011). Because since 1990s, electricity production has been driven toward generation concentration and a higher degree of integration leading to the current centralized generation electricity paradigm:

a) Economies of scale

The increase size of certain centralized generation made it possible to increase the size of it decreases the marginal cost of electricity production. For example the investment in the nuclear plantation, which has big part in the fixed cost but very low cost in terms of variable cost.

b) The search for high energy efficiency

Larger facilities capable of handling higher pressures and temperatures in steam used in electricity generation bring gain in efficiency. At certain point, the gains were however offset by the increase in operating and maintenance costs as materials were unable to sustain operation at high specification over the long run. (Martin 2009)

c) Innovation in electricity transmission

Electricity could be transmitted over long distances with a significant loss reduction because of the use of alternative current rather than direct current.

d) The search for reliability

Transmission networks connected large electricity production facilities in order to increase the reliability at the end customers. Pooling resources helped reduce the reliance of each customer on a particular generator as other generators were often able to compensate for the loss. (Martin 2009)

e) Environmental constraints

Relocation of generation facilities outside the city centres are possible to be implemented because of the use of transmission networks, moreover it removes the pollution because of the exhaust of CHP.

f) Regulation favouring larger generation facilities

Traditional electrical power system architectures reflect historical strategic policy drivers for building large-scale, centralised, thermal (hydro-carbon and nuclear) based power stations providing bulk energy supplies to load centres through integrated electricity transmission (high-voltage: 400, 275 and 132 KV) and distribution (medium-low voltage 33kV, 11 kV, 3.3 KV and 440 KV) three-phase system. (Martin 2009)

The less supportive regulation to smart grid will make barrier to the penetration of DG in the market. Across Europe, the DSOs play a leading role in terms of coordinating Smart Grid deployment. DSO-led projects represent about 27% of all projects and about 67% of investments (Giordano, et al. 2011). In several countries, the situations are incentives offered to network owners or operators in order to improve cost efficiency by reducing operation costs rather than by upgrading grids towards a smarter system. There should be revision in terms of making inactive mode for accelerating the investment potential of network owners or operators and to encourage them to move to a more service-based business model. Regulation should also ensure a fair sharing of costs and benefits in the set up of service-based market platforms network or operators eventually will affect the development of DG in the market.

Regulatory rules and incentives affect the action of the DSOs which generally are natural monopolies in terms of policy of distribution. In order to make sure the guarantee the security and the adequacy of the DG integration to the distribution network, new grid codes, technical

specifications and ancillary services should be defined in agreements between DSOs and suppliers or large customers.

III. Distribution Generation

III.1 Definition

DG is known too as the third generation in power sector reform. The first series of reforms invented independent power producers and the second generation created wholesale and retail competition. In the third generation, decentralised generating sector was created. This third generation enable deployment individual units at or near customers' site and the DSO who has expanded role.

DG is decentralised generation plants which usually connected to the distribution network, generally with small until medium installer installed capacities, equally as medium to larger renewable generation. More precisely the definition according to IEEE team, DG is smaller generating units connected directly to distribution network near demand consumption, as the result of electrical power systems which are evolving centralized bulk system, that usually are connected to the transmission network. The most characteristics of DG in the distribution network are the "numbers" of them that connected to the distribution network. The concept of DG entails a wide range of technologies, applications and effects on electricity network management, strategically cited DG resources can complement the existing electricity infrastructure, relieve network congestion, provide ancillary services and improve reliability (Van Sambeek and Scheepers 2004). Moreover, improved flexibility in electric system planning is possible due to the modularity of DG through the potential suspend lumpy investments in centralised generation, along with transmission and distribution upgrades.

There are several expressions used to make definition of DG such as "decentralized generation", "dispersed generation", "distributed energy resources", etc. The definition varies significantly associate with characteristics of the generators mentioned. Some experts defined DG as a generator with small capacity close to its load that is not part of a centralized generation (Martin 2009). Some expert gave limitation to maximum capacity of distribution generation e.g 30 KW. However, there is no general consensus applied to all over the world on the upper limit of DGs to be set. The limitation rage can range from 1 MW (Mega Watt) to over 100 MW (Martin 2009). Based on this

situation, DG can be defined as a wide variety of technologies, capacities and also the connection that applies to most of the DG which can be seen from the next figure:

Usual connection voltage level	Generation Technology
HV (usually 38-150 kV)	Large industrial CHP Large-scale hydro Offshore and onshore wind parks Large PV
MV (usually 10-36 kV)	Onshore wind parks Medium-scale hydro Small industrial CHP Tidal wave systems Solar thermal and geothermal systems Large PV
LV (< 1kV)	Small individual PV, Small-scale hydro Micro CHP, Micro wind

Common voltage connection levels for different types of DG/RES

Figure 4The Voltage Level for DG or RES, Eurelectric

Source :Eurelectric(Halberg, Alba Rios, et al. 2013)

In the EU, the definition of DG is a distributed generation comprises plants that are connected directly to the distribution system (Directive 2003/54/EC) Art 2 (31)) or on the customer site of the meter. This definition also includes non-renewable generation technologies, such as local combined heat and power (CHP) unit based on natural gas (Cali, Ropenus and Schroder 2009). According to (Dir.2001/77/EC, Art 2.a), the notion of DG and RES are not equivalent. Renewable energy sources consist of renewable non-fossil energy sources, such as, wind, solar, geothermal, wave, tidal, hydropower, biomass, landfill gas, sewage treatment plant gas, and biogas.

They differ from the large generating stations in producing power on a customer's site where some or all is consumed and in sending any surplus power directly to the local distribution network. (Fraser and Morita 2002).The electricity that produces by the DG can be exported via local

distribution network in order to meet on-side needs, if they exceed the need of electricity locally. Smaller power producers, called “prosumers” often operate the DGs. Differently from centralised generation which is dispatched in a market frame under the technical supervision of TSO or System Operator, DG is frequently fully controlled by the owners.

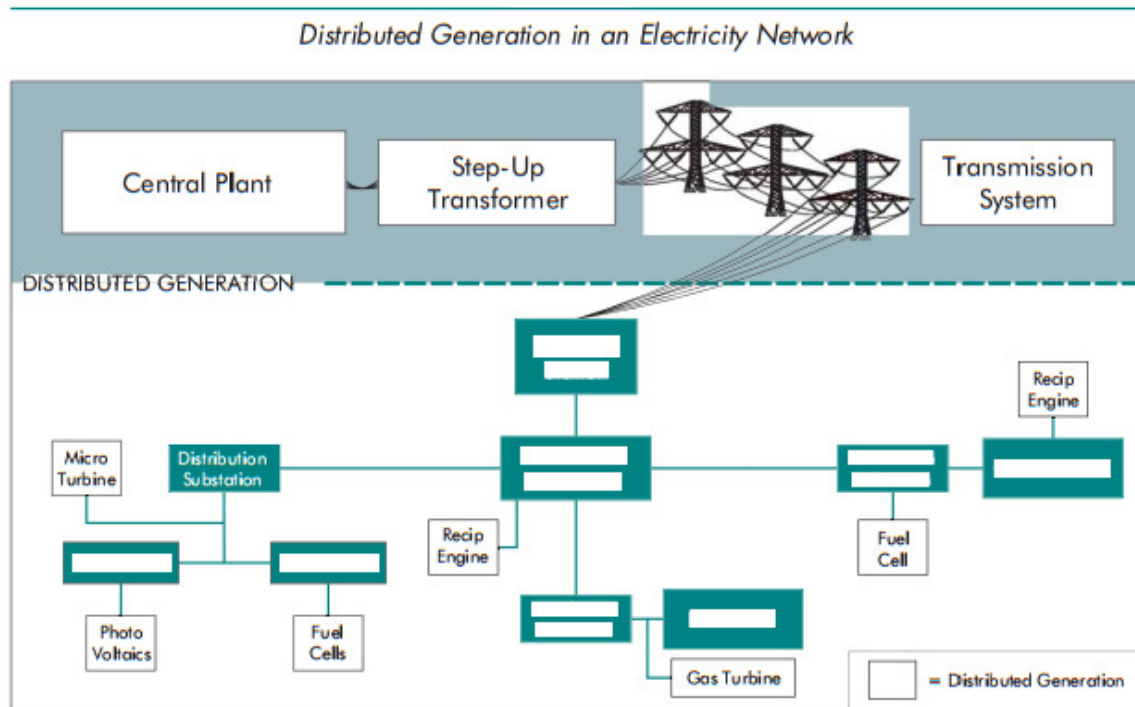

Figure 5 Distributed Generation in an Electricity Network

Source : (Fraser and Morita 2002)

DG is attracting increasing interest and policy attention. There five major factors behind this trend : electricity market liberalisation, developments in DG technology, constraints on the construction of new transmission lines, increased customer demand for highly reliable electricity and concerns about climate change. (Fraser and Morita 2002). Because of the demand in the certain area in Europe and United States because of meeting the demand of those energy resources and also the green policy, there is growth of DG particularly from wind and solar technology. For knowing for about the benefit of DG, Annex 1 will explore more about it.

III.2 Types of technology

There are a large number of generation technologies that implicate in the DG such as small turbines with a steam cycle, small turbines with organic rankine cycle, gas turbines, micro turbines, diesel or gas fuelled reciprocating engines, sterling engines fuel cells (high and low temperatures), photovoltaic systems, wind turbines, and small hydro turbines. DG can be characterized in some different ways for example fuel-based or non-fuel based, renewable-based (fuel or non fuel), non-renewable controllable or uncontrollable (variable output), network connection (isolated, low-voltage, medium voltages' and high voltage).

These are several types of DG technologies used in OECD today.

1) Reciprocating engines

In OECD (Organization for Economic Co-operation and Development) countries, reciprocating engines are the most common technology used for DG (Fraser and Morita 2002). These technologies were proven as technology with low capital cost, large size range, fast start-up capability, relatively high electric conversion efficiency (up to 43% for large diesel systems, and good operating reliability. Due to their ability to start up during a power outage, reciprocating engines were the main choice for emergency or standby power supplies. This type of DG is most commonly used power generation equipment under 1 MW.



Courtesy: Cummins Power Generation

Figure 6 Reciprocating Engines

Source : (N.N, www.esource.com 2011)

Figure6 shows 334-kilowatt lean-burn natural gas generator set, designed to have high fuel efficiency and low emissions for peaking, prime power, and combined heat and power applications.

Reciprocating Engines have two types of engines:

- a) Gas-powered engines: are mainly operated with natural gas, but can be use biogas or landfill gas.
- b) Diesel engines: can use diesel fuel, although can run on other petroleum products for example heavy fuel oil or biodiesel.

This technology works by suing compressed air and fuel. A spark is needed to ignite the mixture in order to move a piston. Then, the mechanical energy is converted into electrical energy.

This type of DG promotes the vast majority of one-site generation. They are mass-produced by many manufactures around the world, cost less than other DG technologies, and have fully developed sales, maintenance, and repair infrastructure. (N.N, www.esource.com 2011). These technologies are a mature technology and largely spread because of their low capital investment requirements, fast start-up capabilities and high energy efficiency when combined with heat recovery system (Martin 2009). Reciprocating engines have several

other benefits such as market familiarity, decreasing exhaust emission, extended service intervals, and long engine life.

The main drawbacks of reciprocating engines are noise, costly maintenance and high emissions, particularly of nitrogen oxides (Fraser and Morita 2002). By changing combustion characteristics, the emissions can be reduced with a loss of efficiency. .

2) Gas Turbines

Gas turbines were originally developed for jet engines, gas turbines of all sizes which are now widely used in the power industry. Small industrial gas turbines of 1-20 MW are commonly used in Combined Heat Power applications (CHP) (Fraser and Morita 2002). This type of technology is notably useful when higher temperature steam is required compare to the one produced by a reciprocating engine. Gas turbines has slightly lower maintenance cost than reciprocating engines. It also has better electrical conversion efficiency than reciprocating engines.



Figure 7 Gas Turbines

Source : (N.N, www.energy.siemens.com 2013)

CHP generation takes place in large fossil-fired power plants or district heating, industry process heating or in decentralised plants for rather small-scale district heating networks. (Cali, Ropenus and Schroder 2009). CHP can reach total efficiencies above 80% compared with lower values for separated heating and electricity generation. In Germany, the electricity generation from CHP aggregates about 80,000 GWh (Giga Watt hour): in most other European countries, a production level between 10,000 and 30,000 GWh is reached. (Cali, Ropenus and Schroder 2009)

In the annual power-generation survey referred to above, gas turbines less than 30 MW accounted for 4.3 GW of capacity ordered worldwide, with the majority coming from OECD countries. From the figure above, we can see Gas Turbines produced by Siemens Company, with primary driver of the single-shaft SCC5-8000H combined cycle power plant, which has an output of over 570 MW and an efficiency level exceeding 60%

Gas turbines are widely used for electricity generation thanks to the regulatory incentives induced to favour fuel diversification towards natural gas and thanks to their low emission levels (Martin 2009). Gas turbines are ordered and widely used as continuous generators (58%) over the period covered by the survey, 18% were used as standby generators and 24% as peaking generators.

Although Gas Turbines are widely used as cogeneration, it has a drawback because of its noisy issue. Fortunately, it has somewhat lower emissions than for engines and cost-effective NO_x emissions-control technology is commercially available.

3) Micro turbines

Micro turbines are built with the same characteristics than gas turbines but with lower capacities and higher operating need. (Martin 2009). Although a Micro turbine has found a niche in power generation, it was originally developed for transport. One of the most striking technical characteristics of micro turbines is their extremely high rotational speed. (Fraser and Morita 2002). It has turbines that rotate up to 120,000 rpm and the generator up to 40,000 rpm. Individual units range from 30-200 kW but can be combined readily into systems of multiple units. (Fraser and Morita 2002).

This technology has low combustion temperatures which are able to make sure very low NOx emissions level. It also produces much less noise than an engine of comparable size. Natural, flare gas, landfill gas or biogas can be used as Micro turbines' fuel.



Figure 8 Micro Turbines

Source : (N.N, Whole Building Design Guide 2013)

Micro turbines offer several potential advantages compared to other technologies for small-scale power generation, including : a small number of moving parts, compact size, lightweight, greater efficiency, lower emissions, lower electricity costs, and opportunities to utilize waste fuels. Moreover, micro turbines are expected to capture a significant share of the distributed generation market due to their small size, relatively low capital costs, expected low operations and maintenance costs, and automatic electronic control.

In 2002, Micro turbines had short track record and still high costs compared with gas engines. At that time, the technology has just been commercialised and offered by a small number of suppliers (Fraser and Morita 2002). As natural gas prices rose and electricity price decreased, Micro turbines' marketing have been shifted from a global market to niche applications. Fortunately, significant cost reductions are likely to be made as micro turbines production volume increases.

4) Fuel Cells

Fuel Cells are built in order to convert chemical energy of a fuel into electricity, despite of converting mechanical energy into electrical energy. Natural gas or hydrogen is generally used as this technology's fuel. The transportation sector is potential market for fuel cells and car manufactures are making substantial investments in research and development. (Fraser and Morita 2002). However, there is potential too in power generation because this technology has potential to be commercialised much more quickly.

This technology is able to convert fuels to electricity at very high efficiencies approximately 35%-65%, compared with conventional technologies. Because of this high efficiency, Fuel cell limits the emissions of greenhouse gases. Furthermore as there is no combustion, other noxious emissions are low. Fuel cells can operate with very high reliability and so could supplement or replace grid-based electricity. (Fraser and Morita 2002).



Figure 9 Fuel Cell

Source : (N.N, Nucleo de Excelencia em Geracao Termelétrica e Distribuida Excellence Group in Termal Power and Distributed Generation 2013)

There are several type of Fuels Cells technology phosphoric acid fuel cell plant (PAFC), molten carbonates (MCFC), Proton-exchange Membrane (PEMFC), and solid oxide (SOFC). A PAFC is currently commercially available. PAFC has output of 200 KW with generally conversion efficiency of 37%. Capital costs are approximately USD 500 per KW, according to the manufacturer (Fraser and Morita 2002). Recently PEMF with its temperature fuel cell is a leading choice for transportation application. Furthermore PMFC is also being tested for power generation. An early field-trial plant of approximately 200 KW yielded conversion efficiencies of approximately 34%. (Fraser and Morita 2002).

The MCFC whose efficiencies are estimated at 50-55% uses high temperature fuel cell. This type of fuel cells is expected to be more economical in sizes above 1 MW. The SOFC is also a high –temperature fuel cell but with similar efficiencies. Several companies plan to commercialise a household-size fuel cell (with a capacity of a few KW) in the next few years. (Fraser and Morita 2002)

The main drawbacks of this technology is that it's still as a major field of research and significant effort is put in reducing capital cost and increasing efficiency.

5) Photovoltaic systems

Photovoltaic Systems are different from other DG technologies mentioned above because this technology is a capital-intensive, renewable technology but with very low operating costs. Photovoltaic Systems produce no heat and are inherently small-scale. Duet to these characteristics, this type of DG is best suited to household or small commercial applications, where power prices on the grid are highest.



Figure 10 Photovoltaic System

Source: (N.N, Solar Energy in Bolivia 2009)

According to the IEA's (International Energy Agency) Photovoltaic Power Systems Programme, the installation cost of a basic photovoltaic system ranges from USD 5000 to USD 7000 per peak KW (Fraser and Morita 2002). The low operating cost is possible for this type of Photovoltaic Systems because of it does not need any fuelling cost. Yet, it has a low capacity factor which ranges from 10% Germany to 22% in California.

Photovoltaic systems have been applied widely and about half of the existing PV systems in the OECD countries are off-grid. In 2007, approximately 1.54 GWP (Giga Watt Power) new photovoltaic capacities have installed in the EU-27 leading to a total installed capacity of 4.689 GWP. (Cali, Ropenus and Schroder 2009) Germany has the highest market share among other member states of European Union with 3.85 GWP photovoltaic capacity installed, Germany has the highest market share for total capacity of nearly 82%, followed by Spain 9.11% and Italy (2.14%). There is also a growth of PV usage in developing countries, serving rural populations that have no other access to basic energy services. Photovoltaic systems are used in order to supply electricity for various applications in households, community lighting, small business, agriculture, healthcare, and water supply.

Regarding the cost of this technology, stand-alone photovoltaic systems are less expensive than extending power lines. Remote telecommunications systems are the recent profitable application of this technology because this type enables reliability and low maintenance. Half of existing Photovoltaic systems are on-grid which is mostly distributed generation. Most of on grid Photovoltaic systems installations have enjoyed very large investments subsidies or favourable price for the electricity they generate (Fraser and Morita 2002). One of the main drawbacks of this technology is the dependency on the weather situation. Although PV operates during daylight hours when demand (and generally prices) for power are higher, changing weather conditions affect its output. (Fraser and Morita 2002).

6) Wind

Approximately 4.2 GW of capacity of wind power were installed during the year 2000. Wind generation is rapidly growing in importance as a share of worldwide electricity supply (Fraser and Morita 2002). Due to its size and location of some wind farms, which makes it appropriate for connection at distribution voltages, Wind power is considered as DG. However, in 2002 investment in wind power increased made in large wind farm by generating companies rather than by individual power consumers. Based on this situation, wind more tended to be considered central generation rather than distributed generation. Fortunately, because of the development of technology, individual homes, farms, or business may have their own wind turbines and generate their own electricity for personal/business use. These turbines are much smaller than utility-scale turbines. The potential of energy produced are 10 KW for residential turbines and 11 kW until 100 kW in size for industrial/business scale turbine. In many locations, if the turbine is connected to the grid, excess electricity not used by the owner of the turbine can be sold to the local utility and distributed for more widespread use. (N.N, Tribal Energy and Environmental Information Clearing 2013)



Figure 11 Wind Farms

Source: (N.N, Tribal Energy and Environmental Information Clearing 2013)

Wind power has experienced a tremendous growth over the last year and accounted for 3.7% of the EU-27 electricity demand in 2007. (Cali, Ropenus and Schroder 2009). In 2007, there were increase capacities about 7% for this technology. Moreover, in EU since 2000 , approximately 30 % of all new power capacity has been wind power, which is over the last years the second highest contribution after natural gas. The share of wind energy is in total installed capacity increase to 7% in 2007.

The following table will depict the general information for DG technologies

General information		Application range	Electric conversion efficiency	Application	Fuel	Comments
Reciprocating engines		Diesel: 20kW _e -10+MW _e (IEA) Gas: 5kW _e -5+MW _e (IEA)	Diesel: 36%-43% (IEA) Gas: 28%-42% (IEA)	Emergency or standby services CHP	Diesel, also heavy fuel oil and biodiesel Gas, mainly natural gas, biogas and landfill gas can also be used	
		By far most common technology below 1MW _e				
Gas turbines		1-20MW _e (IEA)	21-40% (IEA)	CHP Peak power supply units	Gas, kerosene	
Micro turbines		30kW _e -200kW _e (IEA) 35kW _e -1MW _e (A) Small-scale applications up to <1kW _e	25-30% (IEA)	Power generation, possible with CHP added	Generally uses natural gas, but flare, landfill and biogas can also be used	
Fuel cells	Molten carbonate: MCFC	50kW _e -1+MW _e (IEA)	35-60% (IEA)	PEMFC: low temperature applications in transport and stationary use MCFC: high temperature	Methanol Hydrogen or natural gas. Reforming of CH ₄ to H ₂ leads to decreased efficiency	
	Proton exchange membrane: PEMFC Solid oxide: SOFC	PAFC: 200kW _e -2MW _e MCFC: 250kW _e -2MW _e (A)	MCFC: ±50-55% (IEA) PAFC: ±35% (IEA)	Transport sector is major potential market		
	Phosphoric acid: PAFC Direct Methanol : DMFC Only PAFC is currently commercially available	PEMFC: 1kW _e -250kW _e (A) SOFC: 1kW _e -5MW _e (A)	PEMFC: ±35% (IEA) SOFC: ±50-55% (IEA) Electric efficiency of small-scale applications : ~25%	Power generation is the most likely immediate application CHP, UPS		
Photovoltaic	Generates no heat	1+kW (IEA)	not applicable	Household and small commercial applications	Sun	Non-predictable output; capacity factor ~10-15% in Western Europe
		20+kW (A); Every range possible when using more cells		Off-grid applications Developing countries Small scale applications		
Wind	On shore and in-land	200W-3MW (A)	Not applicable		Wind	Non-predictable output Capacity factor on shore ~20-25%
Other renewables	Includes thermal solar, ...		Not applicable			

Figure 12 General Summarise of DG

Source: (Martin 2009)

III.3 Generation and capacity figures

In the figure below, we will see the share of DG in various countries through the world (Gischler and Janson 2011). The first 7 countries that have the highest concentration of DG are from the European region. Denmark is number one in terms of DG concentration in the world. Denmark has reached an advanced stage in DG, with over 50 percent of generation. Denmark's DG is mostly represented by wind energy and industry cogeneration (with a smaller share of hydro) and was developed between the early 1980s and today by a mix of compulsory targets and subsidies for RE (Gischler and Janson 2011).

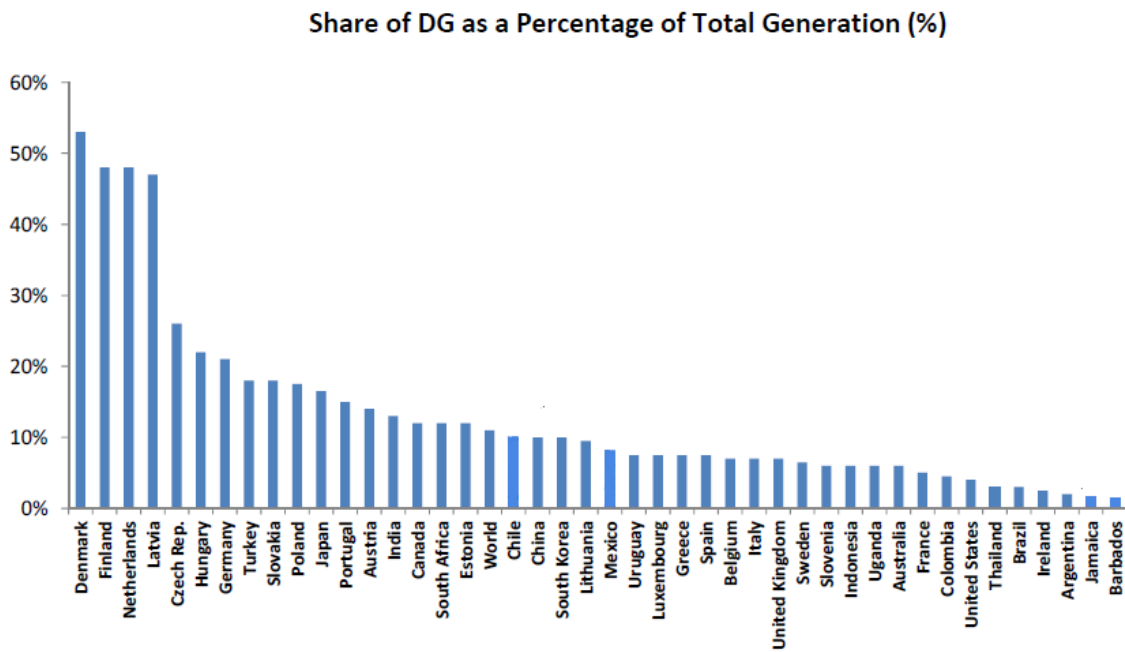

Figure 13 Installed Capacity (in MW) for DG and renewable

Source: (Karkkainen n.d.)

We will have information about the installed capacity for DG and RES in some OECD countries. The table was taken based on research that set a 20 MW limit in size for a unit to be considered as being DG.

Country	Wind (MW)	Solar (MW)	CHP (MW)	µCHP (MW)	Small hydro (MW)	Others (MW)	Estimated Total DG (MW)
Finland	122	marginal	294	N/A	270 (<i><10 MW</i>)	< 20	800
Italy	1500	120	3242 (<i><25 MW</i>)	N/A	4138	672*	9700
Netherlands	1560	53	8500	N/A	marginal		10200
Spain (<i><25 MW</i>)	3705	413	4214	0.788	1702	538**	10600
USA	1078	810	***	minimal	minimal		2000
Austria	1032	36	402	****	1559 (<i><20 MW</i>)	1	5000
Korea	178	36	3455	148	60 (<i><5 MW</i>)	81	4000
Notes * : In Italy, others are biogas (347 MW) and heat & enthalpy recovery (325 MW) **: In Spain, others are biomass, biogas and municipal solid waste fired units ***: In USA, total capacity almost 50 000 MW, most over 20 MW units ****: In Austria, total µCHP generation 6165 MWh, 1172 MW of small hydro capacity <10MW							

Figure 14 Installed Capacity (in MW) for DG and renewable

Source: (Karkkainen n.d.)

As we can see from the figure above the wind technology have the larger capacity in those countries listed in the figure. Moreover from the figure below we can see the renewable energy snapshot with in EU. Wind energy represents the greatest of new renewable generation being developed in the EU over the past 10 years, and it is projected to retain this position for the next year. (Sommerville, Sawler and Vantaggiato 2012). Wind Power contributed alone for 39% of all new European energy capacity installed in 2009.

Solar power is also has potential progress like wind power. In 2009, photovoltaic accounted for 17% of all new capacity installed in Europe, exceeding the amount of new generation produced through conventional energy sources other than gas.

Let us elaborate more with the data from European region, due to the rapid development of RES in this region. As we can see from the figure below, it shows the composition of electricity generation and electricity capacity in the European countries. Most of the countries have the amount of electricity generation as equal as their electricity capacity. But some countries like Belgium and Luxembourg has more electricity generation compare to their capacity. There is probability that these countries import the energy from their neighbours in order to fulfil the need of energy.

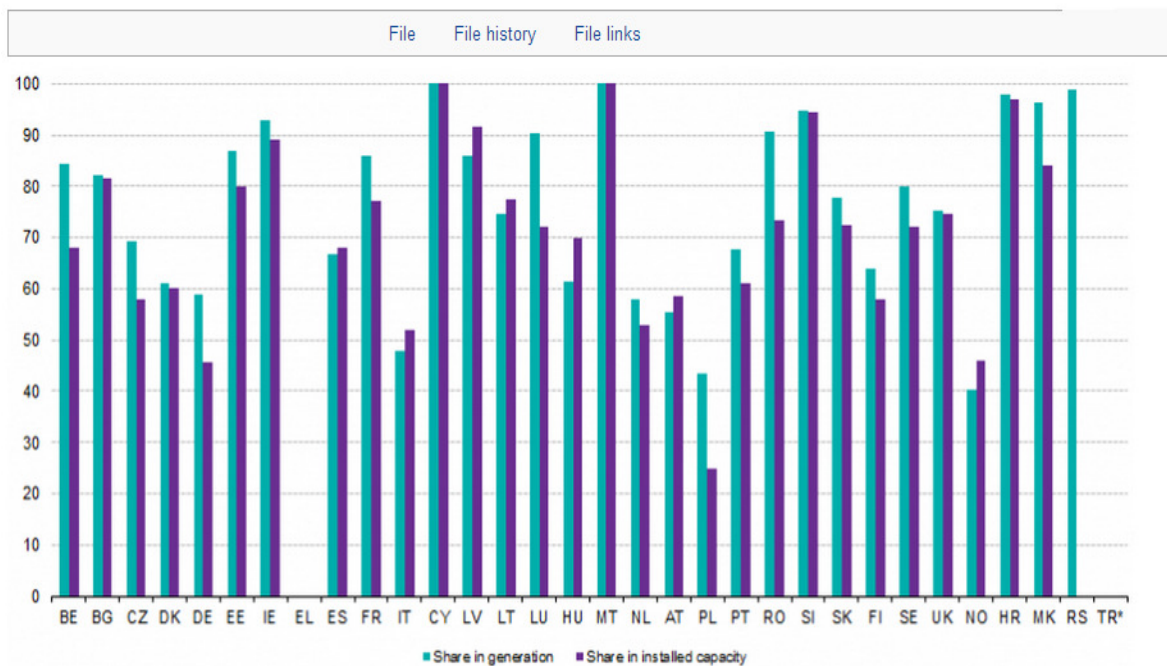

Figure 15 Cumulative Market Share and Installed Capacity share in EU, in 2011

Source:(N.N, Euelectric Power Statistics & Facts 2013)

Notes : BE : Belgium, BG, Bugaria, CZ : Czech Republic, DK : Denmark, DE :Germany, EE : Estonia, IE : Ireland, EL : Greece, ES: Spain, FR: France, HR: Croatia, IT Italy, CY: Cyprus, LV : Latvia, LT : Lithuania, LU: Luxembourg, HU : Hungary, MT: Malta, NL : Netherlands, AT : Austria, PL : Poland, PT: Portugal, RO : Romania, SL Slovenia, SK : Slovakia, FL: Finland, SE : Sweden, UK : United Kingdom, NO: Norway, RS : Serbia, TR: Turkey

Specifically we will see the data of resources of electricity generation from EU Member states, which depicts by the figure below. From 2010 until 2012 there were growths of RES composition, which showed the possibilities of DGs from RES. It is also predicted that in 2020 EU will reach 34% for its RES percentage.

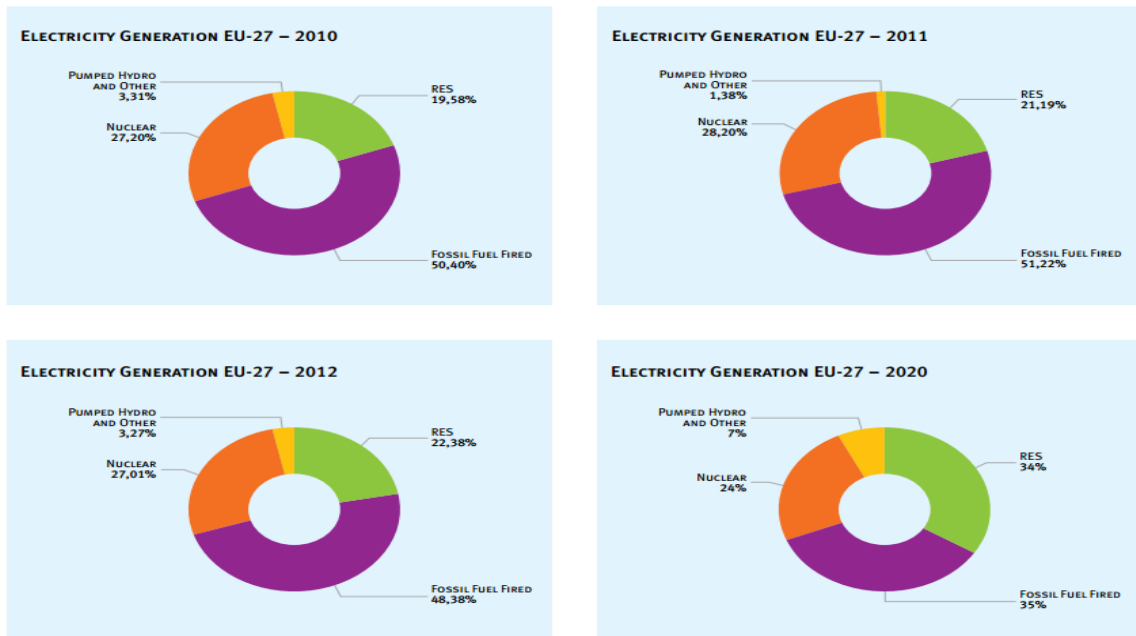

Figure 16 Electricity Generation Shares in the EU27 Countries

Source: (N.N, Euelectric Power Statistics & Facts 2013)

Nevertheless, installed capacity from DG showed in the EU Member States in 2011 and 2013 were more than 30%, as shown by the next figure. From this figure we can see there are still approximately 5% differences between the installed capacity and electricity generation from RES. There will be change that the DG using RES, were producing but the energy was not dispatched.

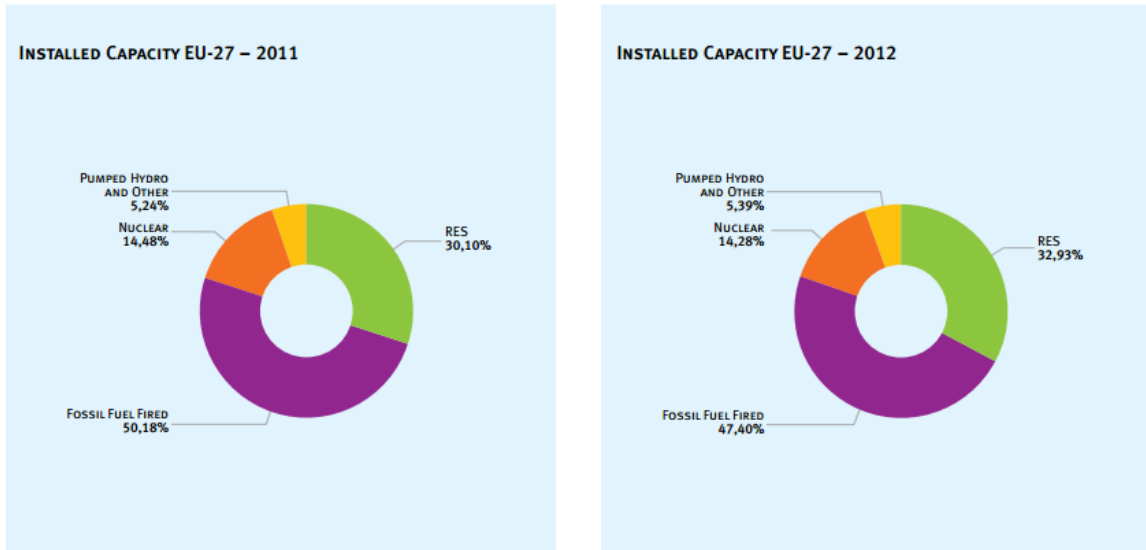

Figure 17 Installed Capacity Shares in the EU-27

Source : (N.N, Euelectric Power Statistics & Facts 2013)

The next figure will show another data from another resource that depicts the RES and DG in Europe

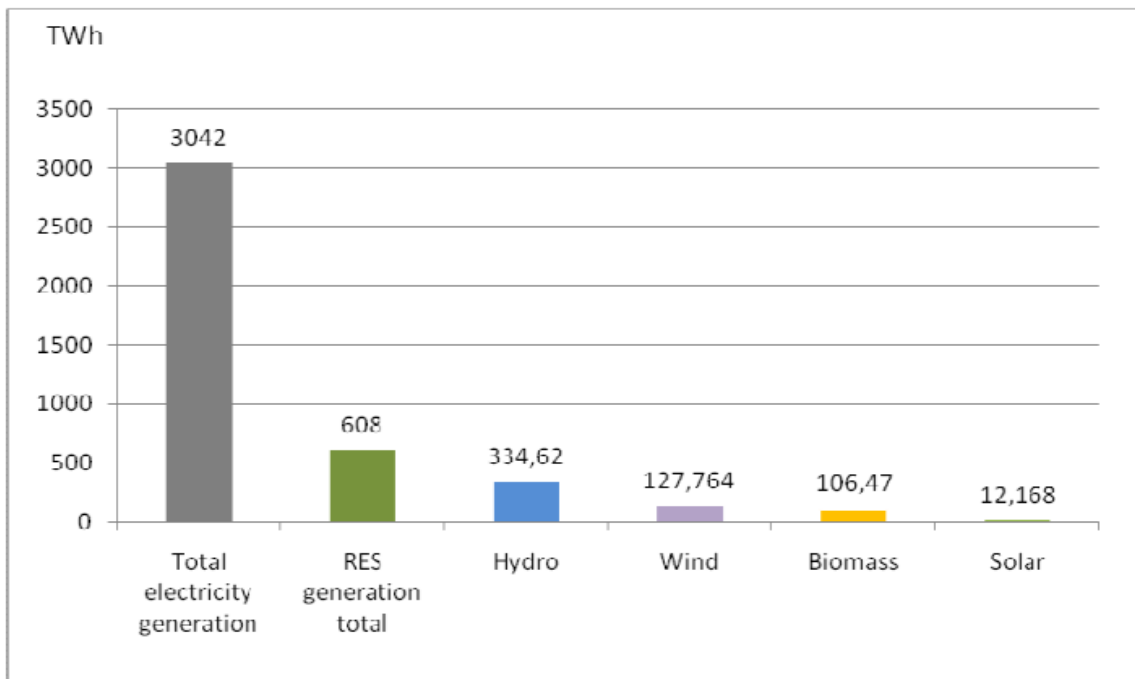

Figure 18 RES and DG in Europe

Source: (Sommerville, Sawler and Vantaggiato 2012)

European Union has the most tremendous growth for its DG renewable, as shows in the figure18. The figure shows that the DGs with RES as resources have a quite rapid growth. According to Pike Research annual worldwide installations of renewable DG will reach 63.5 GW a year in 2017, up from 20.6 GW in 2011, and nearly 232 GW of DG renewable will be added between 2012 and 2017 (N.N, Environmental Leader 2012). Solar photovoltaic will have the large majority of new installations with total 210 GW from 2012 to 2017.

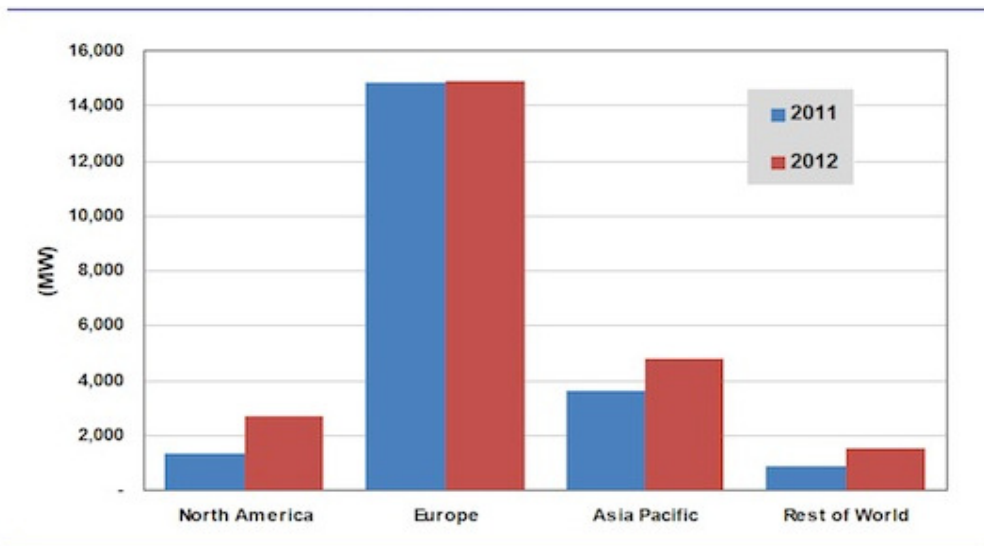

Figure 19 Annual Renewal Distributed Energy Generation Installed Capacity by Region, World Market 2011 and 2012

Source :(N.N, Environmental Leader 2012)

Certain counties in EU show a move from sheer DG connection to DG integration, especially since the obligation of accomplishment 2020 for EU member states. In the next figure, it illustrates the Union FenosaDistribucion (One of Spanish Electricity Company) installed capacity of DG connected to its distribution networks in Galicia, Spain. We can see that from the installed capacity 2.203 MW exceeds the area's total peak demand (1.842 MW)

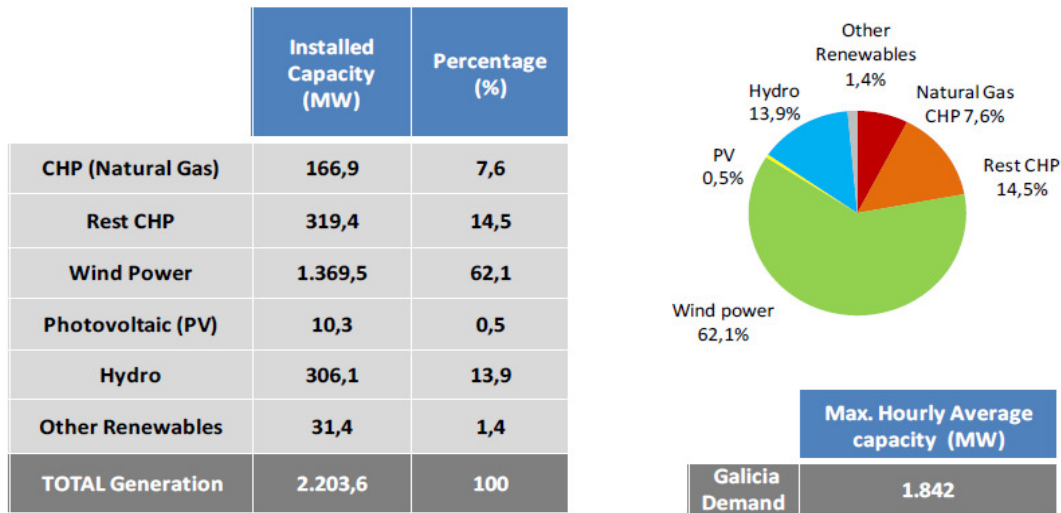

Figure 20 Distributed Generation Installed Capacity and Peak Deman in Galicia, Spain

Source :{(source: Union FenosaDistribucion, (Halberg, Alba Rios, et al. 2013))}

Germany has one of leader in terms of RES in EU, has installed capacity of intermittent renewable DG which already represents a large percentage of the peak load in the regional distribution network in the south of Germany. Figure 24 shows within 10 years this country has tremendous growth of RES and the installed capacity of intermittent renewable DG reflects a large percentage of the peak load. Since the policy to reduce its nuclear power, Germany focuses to develop its RES. From the TSO point of view, the DSO network then looks like ‘a larger generator’ in periods with high RES production(Eurelectric(Halberg, Alba Rios, et al. 2013)).

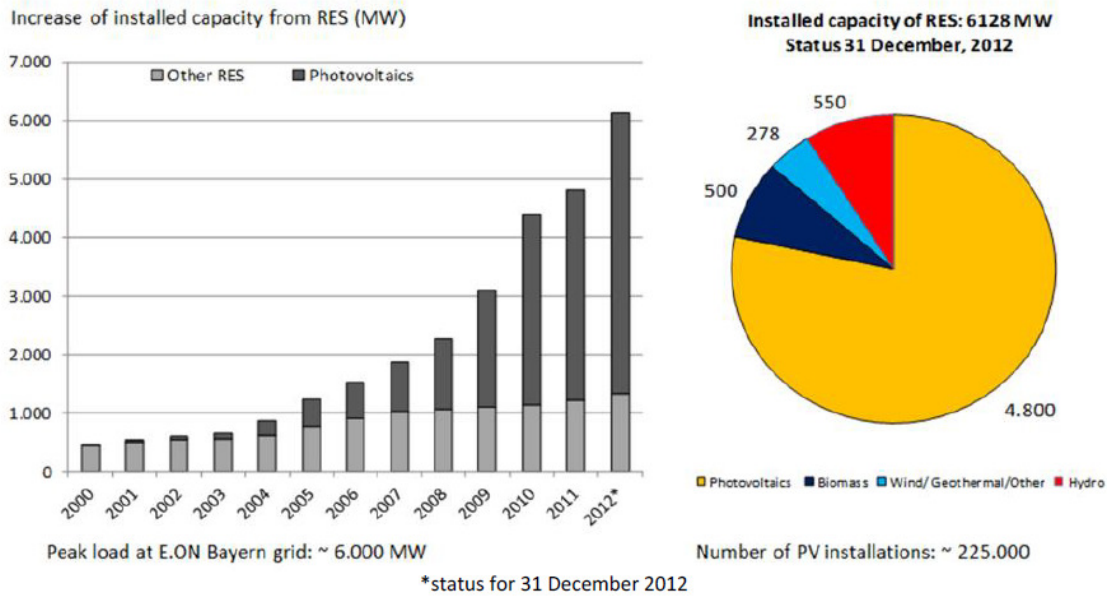

Figure 21 Installed Capacity of Photovoltaic Installations in the E.ON Bayern Grid (Source : E.ON Source :(Halberg, Alba Rios, et al. 2013))

Italy made the highest yearly growth in DG connected to the grid worldwide in 2011 by having 10 GW of PV connected to its distribution grids (EnelDistribuzione). The rapid growth of DG is undoubtedly happen in northwest Ireland whose peak demand of 160 MW, yet 307.75 MW of DG from wind power are already connected to the distribution system in 2012, along with 186 MW DGs are contracted or planned. Furthermore there were 640 MW of DG application had been submitted.

In another continent, precisely in the Central American countries, the data taken in 2009 showed that there was a proportion of the growth in the installed capacity of generation based on diesel and heavy fuel oil increased in the last 20 years by almost 600%. The fuel mix has changed very significantly since 1985, when most of the electricity was produced from renewable hydro resources. (Sommerville, Sawler and Vantaggiato 2012)

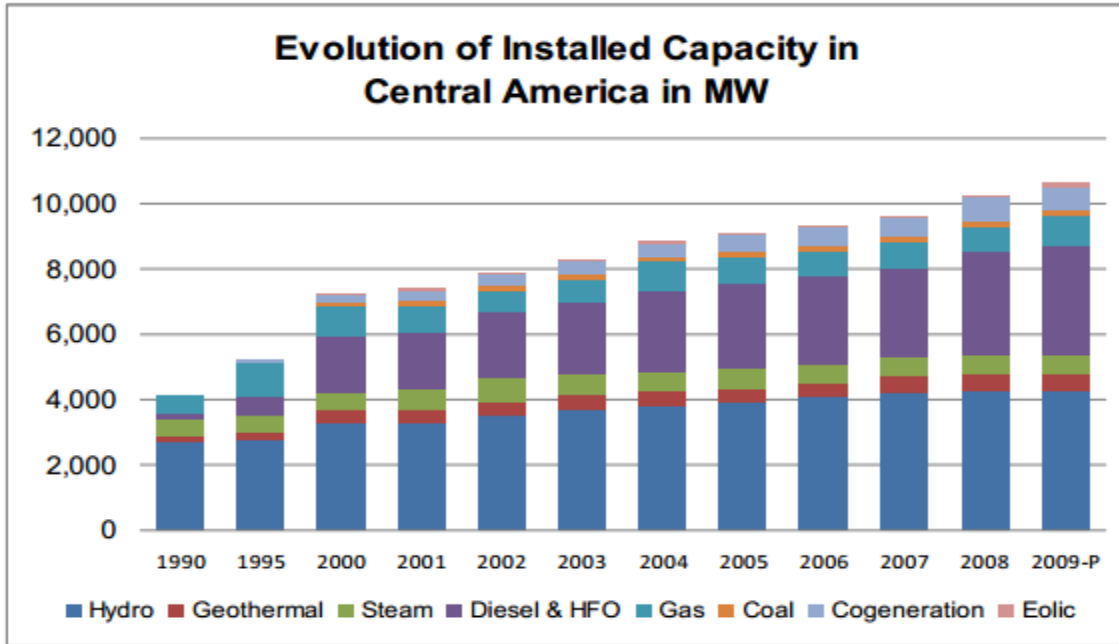

Figure 22 Installed Electricity Capacity in Central America

Source: (Sommerville, Sawler and Vantaggiato 2012)

Eventhough there are growth of DG in all over the world especially in EU and United States that have the largest market for DG with RES resources today, but DG still makes up a very small part of world's global electricity power capacity. Moreover there are still several major barriers that have to overcome in order to integrate DG in the electrical system.

IV. Current barriers to the DG integration

In this chapter, we will elaborate more about the barriers to integration of DG as has already mentioned as the motivation of this master thesis which are market access and incentive schemes for DG, connection and access to the distribution grid, and lack of participation in distributed system services.

We should learn from what happened in Denmark regarding penetration DG issue. For certain period of times, West Denmark managed to increase the DG connection which was apparently with only minor changes in the network control. It was not until the early 2000s that the reliability problems, created by the sudden increase in the wind generation, grew acute-notably the blackouts in East Denmark in 2003 were a wake-up call (Martin 2009)

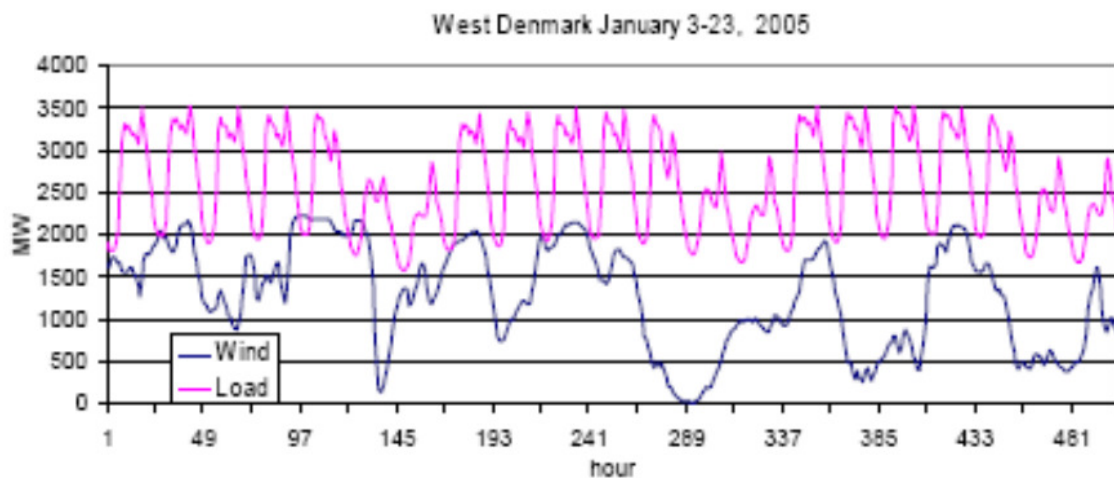

Figure 23 Wind Power Production (2400 MW Wind Power) and Load in Western Denmark

Source: (Karkkainen n.d.)

From the figure above, we could see there is no correlation between the production and the local consumption. In West Denmark, there were increasing problems in electrical networks, which happened both in local distribution networks and transmission networks including cross-border networks. The main

cause of these issues was large amounts of variable generation from renewable source which were not fully forecast able. In long term scope, the significant increase of DG share will advisably imply to remodel the whole physical and regulatory architecture of the electricity network and more precisely the distribution network.

From this circumstance, the energy that has been produced by DG was not dispatched and there was barrier for DG in order to access the market. Moreover, since generally, DSOs do not have incentive scheme in order to promote DG which happen in most of the case in the liberalized electricity market. One of the reason is, as the DG grows so fast, they incur more technical problem, which never happen before during the era of centralized generation. DSOs generally must only responsible for transform the electricity which has been supervised by TSO from Transformation grid, to their distribution grid until the retail market.

Due to the fact that the current infrastructures were not originally made to accommodate a large proportion of DG, the architecture of the electricity needs to be adjusted in order to sustain the growing penetration rate. For the moment, there should be only necessary alternation in order to accommodate these new capabilities. Energy policies are promoting energy efficiency, DG and RES increasing the production from DG and especially variable output (only partly controllable) types DG like wind power, solar, small hydro and CHP. (Karkkainen n.d.)

The next figure depicts the challenges caused by DG using RES; the time scale of the problems varies from milliseconds until years.

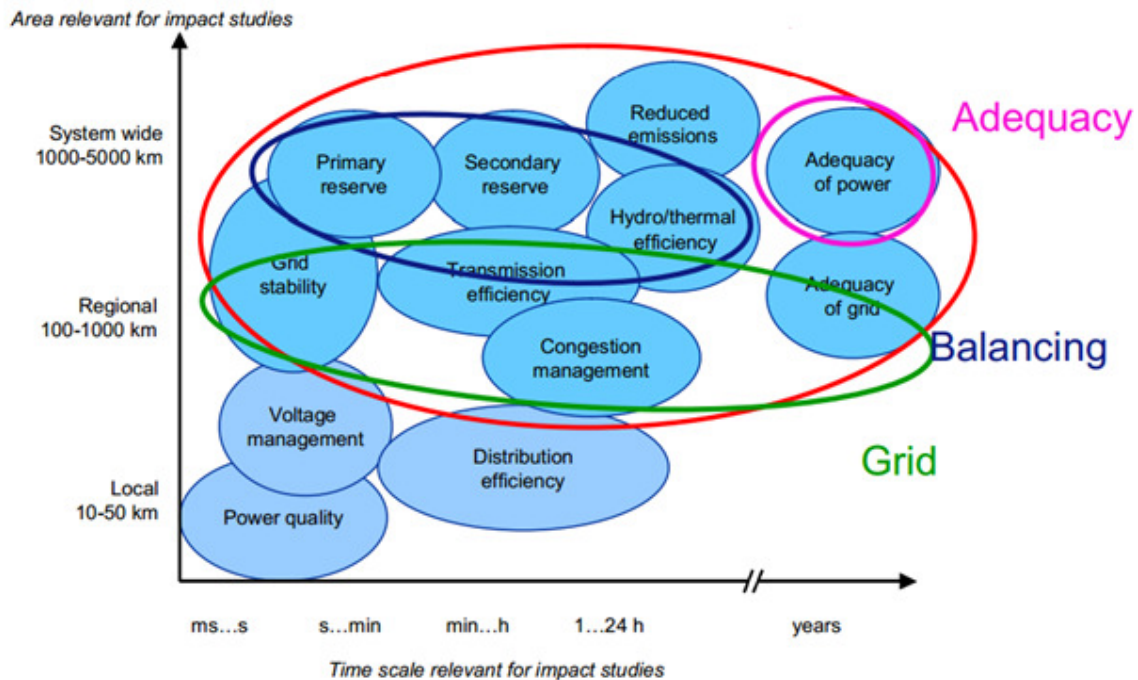

Figure 24 Impacts of wind power on power systems divided into different time scales

Source: (Karkkainen n.d.)

Generally small DG is often fully controlled by the owners themselves, which is not the same like centralised generation, dispatched in a market frame under the technical supervision of TSOs, small DG is often fully controlled by the owners themselves. TSOs are responsible for operation of the overall electrical energy supply system as a whole. Meanwhile DSO should operate a secure, reliable, and efficient energy supply network. Therefore DSOs have the responsibility to receive generated power-in the distribution network or form the transmission system-and to distribute it to the customers. (Corfee, et al. 2011) DSOs have to connect generating units to their networks equally, without discrimination. As the consequence of this circumstance, DG units must be accepted on the Medium Voltage (MV)Level and Low Voltage (LV) Level grid if they fulfil the respective technical network connection requirements.

From the perspective of the technical side the integration of DG with intermittent load, for example wind energy, solar energy and in some cases CHP, could put

forward additional challenges to system balancing. In order to have access to the existing electricity system, DG units have to fulfil the corresponding valid network connection guidelines. Yet, there are also specific grid operational requirements need to be fulfilled by DG in order to support a secure operation of the distribution network. Let alone, increasing amount of DGs entails a transition from centralised control and system management by few actors to a control system that allows and co-ordinates decentralised decision making by many actors in electricity system . New challenges in order to make sure the reliability and quality of power supply occur as the result of huge growth of energy regeneration gained from RES. Distribution part from electricity industry especially in the liberalization needs to make changes in order to adjust with the situation of the coming DG in its network. This technical issue regarding connection and access in distribution grid are issues to integrate DGs in the network.

There are several issues incurs to regarding the roles of DSOs in integrating DG into the electricity system, especially as the DG becomes mature in the development and are growing in terms of amount its penetration. DER will need a lot of support for example Information and Communication Technology (ICT) in order to integrate the high amount of existing and projected DG and later. Moreover, the regulatory frameworks are needed for both network operators and users are needed. DG faces a number of barriers, however, one of which is the fact that in most countries the regulatory framework has been set up with centralised generation in mind. (Khoe, What Are the Regulatory Challenges Facing Distributed Generation? n.d.). There are should be some revision in terms of network planning and operation methodologies in order to give new solutions into this issue. How could DSOs facing all the problems in their own network, without having significant role in terms managing the growth of DG in distribution grid?

There are 3 main groups regarding the challenges that DC faces in order to be integrated into the electricity system, which will be explained in IV.1, IV.2, and IV.3:

IV.1 Market access and Incentive Scheme for DGs

IV.1.1 Why DG is not yet profitable yet?

In the traditional and centralized approach, the focus is on the optimizing the operation of the system as a whole with centralized generation and transmission, often neglecting the potential of distributed resources. (Karkkainen n.d.). Unfortunately in the liberalized market, there are large numbers of actors along with their personal interest, which will be a barrier in terms of giving compensation for the benefits given by DGs. . In EU, which some of the Member States have liberalized their electricity market DGs have to face variety of ways of the market access and the economies of scale of incumbents which bring difficulties for DG units, especially small ones in order to establish themselves in the market? Furthermore, for a new player it is possible trading fees on the spot markets is quite high. Not to mention, the fulfilment of market operation requirements this could obstruct the access to wholesale market.

One of the examples of such players is prosumer who is smaller power producer in charge in operating DG or the owner of the DGs themselves. This situation is different compare to a centralized generation, when the energy dispatched is arranged in a market frame under the technical supervision of TSOs. Even when there is a determination to reach an economical optimized operation in the electricity system, the actual operation is more likely done in order to suit some of those actors' goals. Unless there is enough variety in the units to be optimized, the distributed market based optimization won't work well. Accordingly, a centralized approach is presumably often better for the internal optimization of a local system which is composed only by a few of DGs units

Not every member states of EU support the DG development, especially the one that use RES technology. Some European countries such as Austria, Belgian, Greek and Luxembourg still considers DG less beneficial specifically related to the lack of certainty on the extent to which benefits are passed to DG operators and that they are not sufficiently rewarded for such a net positive for example dampen avoided net losses and grid expansions) (Skytte and Ropenus 2005). Furthermore,

there is a major problem in Greece, where the situation does not tolerate much scope for new independent DG Units because the state owned companies virtually still hold a near-monopoly status.

This cost including the joining the market should be applied to any of the DG technology type. As eventually the DG must enter the market, as commodity. The power generated from DG will be treated as trading well, which will be bought by the end customer. The customers buy their power from a utility purchase power at the wholesale market (trading) and the transmission services from the distribution company. In the wholesale market there are several possibilities of transaction either bilaterally (Over The Counter (OTC)), or through an organized market (Power exchange) such as spot market, intraday market or balancing market. Normally the main actors in any electricity market are large power producers as power provider and traders; utilities and large industrial facilities as customers. It becomes an issue in the electricity market, as the integration of DGs into electrical system become massive, and these technologies are not mature enough to compete with centralized generation technologies. Consequently, DGs have to follow the rules in the market such as minimum capacity requirements for bids and other determinants that enable them to join the electricity market.

From the next figure, we will have information about the phases of new technology from it is built, grows, until it enters its mature phase and can survive in the market. The learning curve shows the possibilities of new technology to survive until it becomes existing technology or it will always ask for investment and become disruptive technology. Following the creation of a technology, refinements to that technology and the economies of scale that accrue as manufacturing and widespread distribution will develop until an equilibrium cost/performance is reached (N.N 2013). While the DG technology penetrates the market and try to put its price position, generally it would still need support from the government.

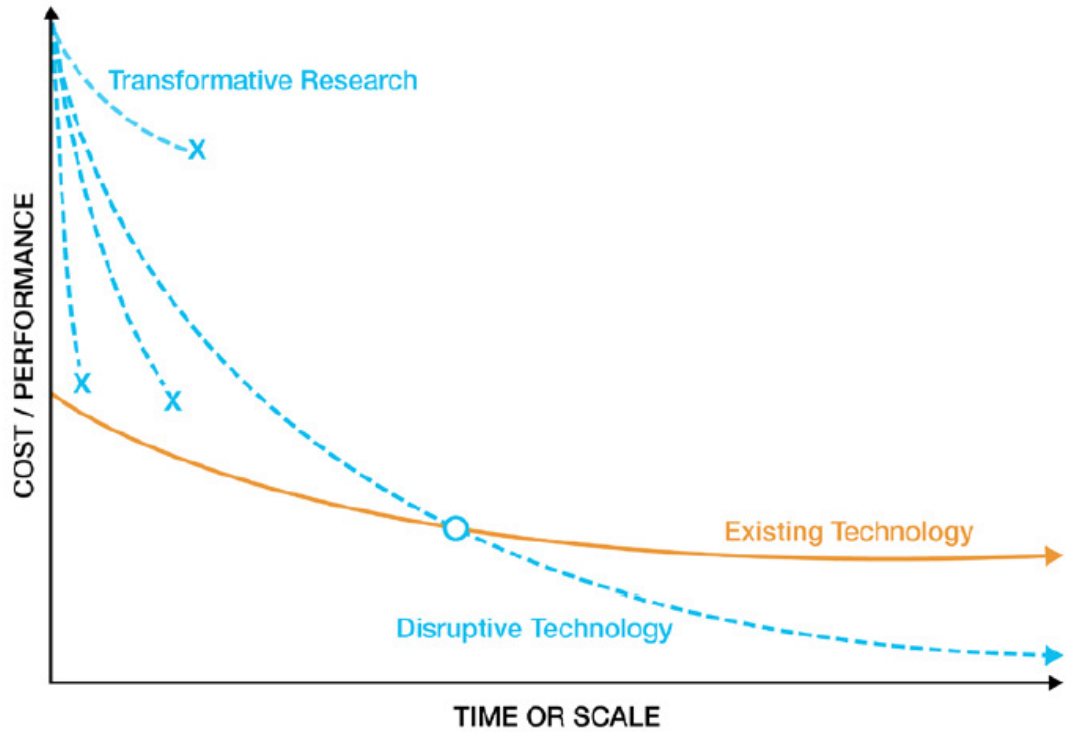

Figure 25 New DG technology learning curve transformation in terms of cost, performance and time scale

Source :(N.N 2013)

Just like the other new technology concept, DGs and especially those that use RES technology are not economically viable yet and may therefore still need support from the government of each country. Not to mention the treatment to DGs are the same like the incumbents, which is the cost of connection and access to distribution network should also be applied to the DG owners. Every DG with all their variant cost has its own learning curve. Not to mention the situation of investment that is unique for every country. The centre of Figure 31 shows that there is a desirable combination of cost and efficiency; moreover there is a noticeable gap as system size decreases. Each type of DG has a wide variety and a commensurately broad assortment of cost, but generally these costs includes financing cost, fuel purchases and operating and maintenance (O&M) expenses.

1. Equity Cost

It depends on the type of technology used by DG. Newly positioned DG will need large investment for individual investor, even if generally not as big as centralized generation such as nuclear generation. Equity cost can decrease because of advancements in manufacturing processes, incorporation of less expensive materials, and more streamlined installation method.

2. Stranded Cost of the old DG

Stranded cost is the costs arise when regulatory changes allow the construction of new generation such as DG, rendering some old generation assets redundant. The major problem is whether the DC customers should, through the tariffs they pay, compensate utility companies for these stranded costs. An option that has been proposed for dealing with stranded costs is an 'exit fee' charged on all customers who decide to leave the grid or reduce their load through DG, since previous investments will have been made with these consumers in mind (Kroe, What Are the Regulatory Challenges Facing Distributed Generation? t.thn.) Obviously this situation will not encourage the penetration of DG if the amount of DG connected is less than overall demand growth.

3. Finance Cost

There are possibilities for investor to have low interest rate and longer finance period in certain countries, but unfortunately, these possibilities depends on the time and the situation in the market. If the technology used is favoured by the local government in each country, there is possibility of financial support. If not, the investor will still think it is expensive to invest in this new technology and consider that this investment will not profitable. Traditionally many DG projects were financed using a firm's working capital either through free cash flows from other operations or through a debt/equity arrangement to maximize the firm's return on investment (Price, et al. 2011).

Financing problem could be a big barrier to the development of DG and thus its integration to the electricity system. As a new technology compare to centralized generation, banks may consider DG projects unattractive due to a lack of familiarity with the technologies involved, or the relatively small scale of the projects. As markets liberalise, there will be transition periods of regulatory uncertainty which increase the perceived risk levels of a project, which in turn may raise the cost of financing (Khoe, What Are the Regulatory Challenges Facing Distributed Generation? n.d.).

4. O&M Expenses

There are several O&M expenses that must be taken into consideration by DG owners, for example: Increase fuel transportation costs for gas fired, net metering cost, non by passable charges (PGC, DWR, nuclear decommissioning), utility interconnection, fuel cost and so on. The DG costs are strongly influenced by fuel cost. Even though some types of DGs that use RES technologies such as wind and solar PV have no fuel costs, there are some others such as combustions based that use conventional fuel like natural gas; or renewable resources for its fuel like biogas.

The other barriers of DGs have to overcome regarding market access and intensive scheme is cost competitiveness of DGs. This parameter varies a lot from one technology to others mainly because of the age of the technology and its current state of development. For example at the period of 2009, reciprocating engines have been used for decades and are mature technology while fuel cells are still subject to significant research and development in order to become a credible source of generation. (Martin 2009). A mature technology needs more than 5 years of research development in order to be adopted on a large scale.

The next figure shows a table that gives indication of the capital costs, operating and maintenance costs and fuel cost of the different technologies, (all costs measures are in \$2000). As different technologies

are used, DGs are highly sensitive to their inputs. This data are really connected to the data for fuels cells.

	Efficiency (%HHV)	Unit size (MWe)	Capital cost (\$/kW)	Fixed O&M cost (\$/kW-yr)	Variable O&M (c/kWh)	Fuel production costs (c/kWh)	
						1999 average	2001 average
Gas reciprocating engines	29	0.2	750	15	1	0.68	1.19
Diesel reciprocating engines	35	0.2	700	15	1	1.05	1.44
Micro-turbine	25	0.06	800	15	0.6	0.68	1.19
Fuel cell	38	0.1	3000	15	0.6	0.68	1.19
Gas turbine	29	10	480	15	0.55	0.68	1.19
CCGT (centralised generation)	50	200	550	15	0.55	0.68	1.19
CST (centralised generation)	33	500	1100	15	0.4	0.38	0.42

Figure 26 Cost Comparison between DG technologies

Source: (Martin 2009).

We can see from the table above, for most of the costs which are capital costs, fixed and variable operating, and maintenance costs, DG technologies are less or as costly as CCGT (Combined Cycles Gas Turbines). Even though coal steam turbines incline to have higher capital costs but this technology still highly competitive because of its cheap fuel costs. Unfortunately, in terms of pure cost per kilowatt basis, DG is obviously not the cheapest source of generation.

5. Network connection cost

The connection charges should be applied to DGs just like other generation, which will be additional operational cost to DGs owners. There are two types of connection charges: shallow and deep charges. DGs operators only pay the connection cost to the nearest point in the shallow charge, while network operators will bear all further necessary expenses such as converter stations and grid reinforcements. Meanwhile, deep

charge is more complicated to calculate because DG operator has to pay for all expenses associated with its grid connection, including upgrades at the transmission level. The challenges will be how to apply this charge to a new entry DG in the market.

DGs operator should also aware at what cost level they are in. Generally there are two types of charges which are physical connection to the network and use-of system charges.

5.1) physical connection or known as paid at once charge has two types of charges, which will have major impact on the penetration rate of DG. Those types are :

5.1.1) Deep connection charges

DG needs to pay for all the cost of connection under deep connection charges, including upstream network reinforcements. Deep connection charges will be detrimental for small scale DGs and to some extent peaking distributed generators, because the investment needed for connection will significantly reduce the net present value of the investment and can to some extent make it become negative (Martin 2009).

5.1.2) shallow connection charge

Contrary to deep connection charge, in shallow connection charge DG has to pay only the direct costs of connection and part of the reinforcement of the system proportional to its system use.

5.2) Use-of system charges

This type of charges is not a major issue for DG because the regulation is mostly favourable to DGs as they are not required to pay this charge. This feature is bound to change if DG accounts for a large share of total generation. (Martin 2009)

IV.1.2 How are we are going to open ways to this market access issues?

The next figure27,shows how DG is projected to evolve into a mature technology to the market. The figure depicts the capital cost reduction timeline based on the learning curve. It is indicated that DG will be a commercial product around 2025,

after the first DG unit came in 2020. It is beneficial from an economic perspective to invest in Research and Development (R&D) to bring the cost down to a reasonable value before embarking on large scale manufacturing with reliance on increased capacity to achieve the cost goal (Krulla, et al. 2013).

We can also see from figure 27 that there are several contributions from the local government in the beginning of the building of DG technology, and then the development continues to the phase where there are possibilities of industry partnership, utility aggregator, and so on until the cost are reduced and the DG becomes a mature technology. Support Schemes given to the DG as the new entry in the market are typically granted on the basis of technologies for example RES or CHP. Based on the inclusion of positive externalities associated with their deployment, the provision of support for DG is given. An externality arises in the market if the actions of either consumers or producers lead to cost or benefits that are not reflected in the price of the product in the market (Cali, Ropenus and Schroder 2009). Comparing to conventional thermal generation, a lot of DG technology either from CHP or RES technologies are not yet competitive to them.

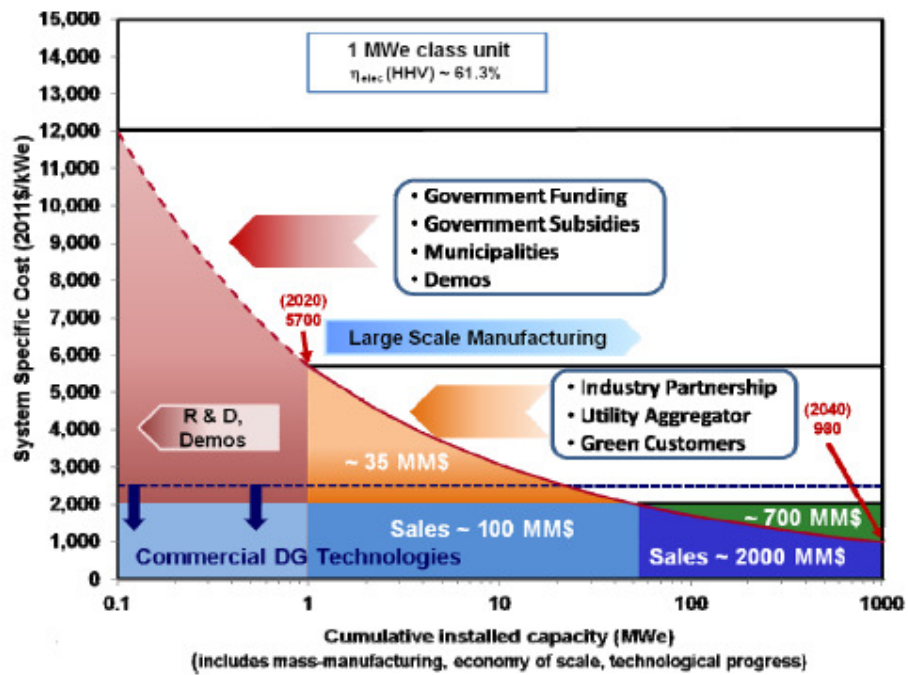
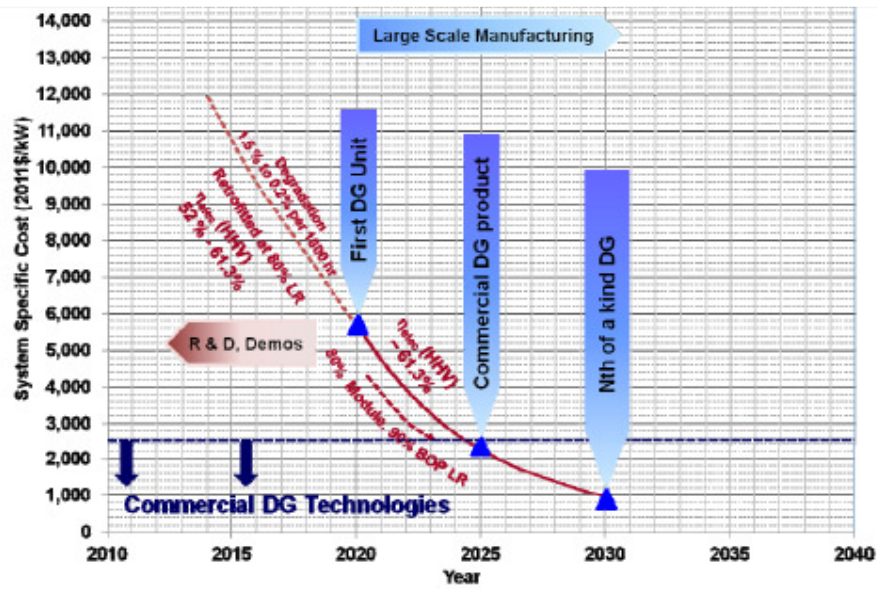

Figure 27 System Specific Cost Timeline

Source :(Krulla, et al. 2013)

There are important economics factor that need to be considered while waiting for the DGs to become mature and survive in the market such as support scheme (revenue), connection charges and network tariffs. Regarding the support

scheme, any government has possibility to choose whether to give feed-in tariffs (FIT), price premiums and quota systems. The challenge will be, the time needed to support the chosen DG technology until it can compete with the other power generation player. The government needs to have enough funds and calculate it carefully, not to mention, which kind of technology will be suitable to each country. Government need to figure out the possibility and feasibility of national support schemes. Investment and also operational cost must be calculated in order to encourage the DG owners to participate in the electricity system.

The rationale for the provision of support for DG either from CHP and RES-ES is based on the inclusion of positive externalities associated with their deployment (Cali, Ropenus and Schroder 2009). The positive externalities offered by the DG, which arises in the market are not reflected in the price of the electricity product in the market. As we concluded from IV.1.1 DG with all its variant technologies are not yet competitive compared to the technologies of conventional thermal generation. Nevertheless the low emission impact that offered by it especially from the RES technologies will contribute to the refinement of energy efficiency. Simultaneously, the deployment of RES-E reduces the import dependency of the EU on primary energy sources from external suppliers while intensifying competition with the market penetration of new RES-E and CHP producers (Cali, Ropenus and Schroder 2009). Therefore, in this region, integrating of DG will fulfil EU's energy policy such as competitiveness, sustainability and security of supply, which also stimulate and promote the support scheme for these technologies.

Support schemes that can be offered for the integration of DG in the electricity market, generally can be divided into investment support and operating support. From the figure below we can see the support scheme for DG offered in EU.

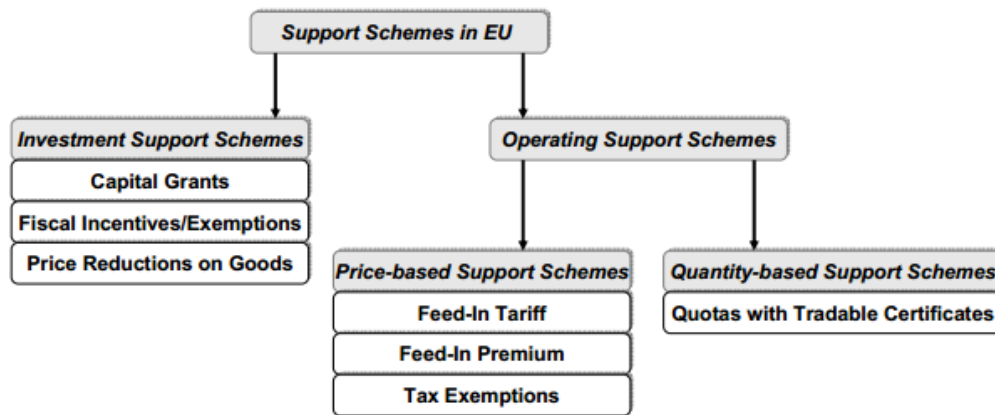

Figure 28 Overview of Support Schemes (Investment and Operating Support)

Source : (Cali, Ropenus and Schroder 2009)

The Investment Support Schemes can be offered for the DGs owner in terms of covering the equity and finance cost. It comprises capital grants, tax exemptions and price reductions on the purchase of goods. This type of support has no relation to production (kWh), but rather to facilitate upfront the penetration of a DGs production site. This mechanism of promoting renewable energy is mostly used to stimulate investments of energy technologies which are still very far from economic viability (Cali, Ropenus and Schroder 2009). The DGs' investors are able to take the same benefit effect from tax exemptions. Meanwhile, capital grants is another alternative of investment support schemes that can be combined with other support schemes.

In terms of supporting the DGs' position in the electricity market, operating support scheme has the major role in covering the O&M cost, and connection cost, until the energy can be dispatched to the electricity market. These operating support schemes which can further be differentiated into:

a) Price-based Support Schemes

Feed-in tariff schemes and price premiums constitute the predominantly applied price-based support instruments in the EU-27 (Cali, Ropenus and Schroder 2009). Both of them are generally socialized and in most cases are used in order to promote specific technology and to induce future

cost-reductions by applying dynamic decreasing tariffs/premium in the operational. As the technology used by DG becomes mature, the duration of support schemes given, represents an important parameter for an appraisal of the actual financial incentives

a.1) Fixed-in tariff system is a system that grants electricity producers a fixed price per kWh above market rates set by the federal or provincial authorities for any qualified electricity technologies, which currently it favours RES. The government could differentiate each tariff rates according to generation technologies, based on the latter's state of maturity and resource conditions in the relevant to each country. This situation enables technology and site specific promotion. Feed-in tariff schemes furnish a high level of investment certainty which bring investor confidence by reducing risk exposure to price volatility on power market. The effectiveness of feed-in tariffs in promoting RES-E penetration has become evident in terms of the wind capacity revolution in Denmark, Germany and Spain (Cali, Ropenus and Schroder 2009).

a.2) Price premium is another continuation form of fixed-in tariff, which applied as a market-based variant of it. DGs owners who used RES as their resources are entitled to a premium paid additionally on top of the wholesale market price, frequently equipped by a premium for balancing cost. Comparing to feed-in tariff, price premiums support scheme introduces competition between producers on the electricity market. The exposure of generators to the volatility of the wholesale market price provides incentives to adjust output following variations in demand and supply of power (Cali, Ropenus and Schroder 2009).

b) Quantity-based Support Schemes

There are two possibilities of quantity-based support schemes which are tendering systems and quota obligations

b.1) Tendering systems, in this support schemes in order to get awarded a contract of a (publicly) funded RES projects like support by means of power purchase agreement. There are possibilities how to select in order to judge of the bids may be applied and depend on the contract award mechanism. For example all participants only compete to offer the lowest bidding price, if the chosen procedure is lowest-bid tendering procedure. In a competitive bidding system, the proposal of RES operators is ranked in increasing order of cost until the amount to be contracted is reached (Cali, Ropenus and Schroder 2009). A long-term contract to supply electricity can be obtained by each selected generator at the pay-as bid price. France uses tendering support schemes as its quantity-based support schemes form. Possibility to differentiate between technologies and RES are allowed by tender as procurement mechanisms in order to avoid competition between same technologies project such as wind projects or between biomass projects

b.2) Quota obligations which is like renewable obligation, is adopted by United Kingdom. In quota obligation, minimum share of RES in total electricity generation are imposed on consumers, suppliers or producers. Tradable green certificates can be combined with quota obligation in order to arrange the amount of kWh of green electricity produced. Separate financial market can trade these green certificates. DG owners, especially which use RES are able to generate income by means of the wholesale electricity price, moreover by means of the green certificate price whenever they sell their certificates on the certificate market. In a similar fashion, the instrument of white certificates may be applied to achieve a quantitative target in energy saving; and if the imposed obligations are not fulfilled, the producers have to pay a penalty

which is arranged by the government (Cali, Ropenus and Schroder 2009).

IV.1.3 The Challenge of Prioritization Access for Support Scheme

Not enough about the financial form the support scheme; the challenge will be how to prioritize access which eventually, the situation will support the integrating of DG. The prioritization of access should be arranged at the national level on the basis of technological characteristics, which will be given to the DG/RES operators. In EU, Directive 2001/77/EC(the “RES-E Directive”) contains the legal provisions on the promotion of electricity based on RES. Member States may give direct or indirect to RES-E producers (Art.4) and may further provide for priority access to the grid system for electricity produced from RES (Art.7 (1)) (Cali, Ropenus and Schroder 2009). The target percentage of RES sharing in its electricity resources were the main reason for these support mechanism. Every Member States is advised to have shared of 20%from RES in overall its energy consumption. In a similar fashion, for DGs using CHP resources, Directive 2004/8/EC (“CHP Directive”) lays down that direct or indirect support may be provided to producers of cogeneration (Art.7) (Cali, Ropenus and Schroder 2009).

IV.2 Connection and Access to the Distribution Grid (Technical Constraints)

In order to encourage the integration of DG by applying the support scheme which eventually open market access to DGs, there are technical constraints should be considered by DSO. In general, all possible combination of production and load situation must be able to overcome by distribution networks. The design of distribution network basically is to be able to bear peak load that probably occurs for a few hours per year. In some countries in Europe, there is regulation that arrange for feed-in of renewable energy or other prudential power production and remuneration in order to adapt with constraints of short duration that triggers grid adaptations (e.g. reinforcement). DG affects the declination of

network asset's utilization rate even though distribution networks have always been designed in adaptation to reinforcement situation.

In normal operation network connection is supposed to be designed to guarantee that under normal operation all capacity can be injected at any time of the year. EU also asked its Member States to ask each of their DSOs to take into account DER and conventional assets in terms of planning their networks. Moreover, there are priority and guaranteed network access for electricity especially for RES in European regulatory framework, which are arranged in RES (Art.16 of RES Directive 2009/28/EC) and RES-based CHP (Art. 14 of the new Energy Efficiency Directive 2012/27/EC).

IV.2.1 Connection

Electricity connection is relation between two points that enable the flow of electrons (electric current), which is needed for a circuit in order to transfer electrical energy. Generation connection is arranged particularly by coordination between TSOs and DSOs. There are several criteria of connection that must be fulfilled by any generation including the DGs. Minimum technical criteria that must be fulfilled in order to make sure proper integration into the network is the equipment and its protective relays must be able to resist voltage dips and prevent islanding and there should be separate metering for production and consumption ((Eurelectric(Halberg, Alba Rios, et al. 2013))). Like other generation, DG should take the burden of the costs which including connection fees.

In the first request for DG connection, the available capacity of the existent network will be given at a low cost; however as the connection increasing, DSOs need more complex and expensive network development solution. In countries where generators bear grid connection as well as grid reinforcement/extension costs (deep connection charges), this may make the individual projects economically unviable ((Eurelectric(Halberg, Alba Rios, et al. 2013))). In countries where generators bear grid connection cost but not the grid reinforcement cost (shallow connection charges) and do not pay any use of the system charge, those

reinforcement network costs are socialized ((Eurelectric (Halberg, Alba Rios, et al. 2013)).

There would not be one-size-fits all approach in terms of DG connection solution, because of the various generation mixes, distribution of generation over different voltage levels and geographic distribution of the resources. Assessment and alternative solutions should be given to network customers in terms of choices between firm injection and higher connection charges and non-firm injection and considerably lower connection charges. DGs connection needs to be supported by network access rule in order to make sure the stability of the distribution network.

IV.2.2 Access

Access is a privilege assigned to any party (either producer or consumer) in order to have the means, opportunity, and enter the grid for the electricity energy. The fundamental to the success of DG is managing the access regime under which the connection to the grid. As the consequence, proper analysis and consideration in the planning process must be done in order to give access to the connection of DG. Traditional regulatory approach refers that in terms of connection request; the network operator obliges to do an individual analysis and supports an individual solution for every connection. Before reaching the maximum capacity the connection will be based on available capacity of the existent network. Then as the demand increases for any new DG connection in the same area, limitation of network capacity should be kept in order to achieve optimal condition from the overall cost and network development services.

Network access has important role in terms of the DGs' success integration. Two main principles in order to arrange the access are transparency and clear determination of the DG benefits. Transparency has goal in order to make sure there is no discriminatory and inhibit the possibility of DG entry barrier by DSO. One of the possibility barriers is when DSOs own the DGs and they do not want

any competition. DG owners must have knowledge about the arranged reward for the benefits they provide.

IV.2.3 Non-firm (interruptible) connections versus firm connections

There are two connections that can be defined regarding the connection of DG in order to realize and increase capacity that allows the connection of more DG in a cost-efficient way which are non-firm connection and firm connection. Non-firm connection is a connection in which a full export of the generation capacity to the distribution network is not guaranteed. This means that in the presence of network constraints (e.g. voltage and thermal constraints), the DNO reserves the right to reduce the generation output based on the terms and conditions set in the interruptible contract agreement (Anaya and Pollitt 2013). Frequently Non-firm connection permits the producer to connect larger capacity in exchange in order to reduce the generation capacity during certain period. For instance, the financial viability of wind generators may not be negatively impacted if a curtailment request is made during summer nights, due to the low price of electricity (Anaya and Pollitt 2013). For the connection with uncertainty condition because of variable energy sources for examples wind, wave and tidal, non-firm connections is more appropriate because the nature of the resources like unpredictability and intermittency.

Meanwhile, a firm connection is a connection that permits the full generation capacity export to the distribution network, and also known as tradition connection. Making sure the guarantee capacity will be exported, this type of connection may need the reinforcement in the distribution network. The option of firm connection is more reasonable for non-variable energy sources due the sustainability of the maximum output for extended periods (Anaya and Pollitt 2013).

Firm or variable access contracts can be chosen by DG developers in order to stick on their own business plan. With pre-defined mechanisms for DG in order to reduce their output to a predefined limit in infrequent situations which expected

only for a few hours per year, it is possible to offer variable network access right, as discounted connection contract for generation customers. The situation will be more than balance the cost of connection in all other hours if only few hours of re-dispatching per year are needed in order to limit peaks of production and use network capacity more efficiently because of a higher installed DG capacity relevant to justify network reinforcement.

There are some necessary connection and access problems in order to make sure high system reliability with DG which regarding technical constraints:

a) Capacity

Because of DG production profiles, location and firmness, integrating DG in the feed into DSO grids tend to incur a capacity challenges. The location of DG which is not always close to the load and non-dispatchable (DG is not able to control its own output) of DG production. Therefore, production does not always coincide with demand (stochastic regime) and DG does not necessarily generate when the distribution network is constrained ((Eurelectric(Halberg, Alba Rios, et al. 2013)). Furthermore, DSO must consider how to inject power to higher voltage level where the local capacity exceeds local load. This circumstance brings challenges for both distribution network development and operation.

The amount of power to be dealt by the equipment (cables, lines and transformers) are affected by adding DG at the distribution level. Reinforcement will have to be undertaken to prevent overload problems by DSOs. The ability of DG to produce electricity close to the point of consumption alleviates the need to use network capacity for transport over longer distances during certain hours; however the need to design the distribution network for peak load remain undiminished and the overall network cost may

even increase ((Eurelectric(Halberg, Alba Rios, et al. 2013))). The critical piece will often be the transformers (converting medium voltage to low voltage or high voltage to medium voltage): if power generated exceeds consumption by far, power will have to flow back from the low voltage network to the medium voltage network or from the medium to the high voltage network and be directed to other consumption areas(Martin 2009). The reverse flow needs to be handled by transformer for example by being able to alter back and have specification to cope with potential oversupply. The main problem will be at peak hours, when both continuous and peaking DGs will operate to cash in the price premium. Production forecast from peaking DGs is a key to determine the specifications of the equipment, as capacities will be added when the total power flow is already significant (Martin 2009) Congestion may happen when excessive DG feed in pushing the system beyond its physical capacity limits.

.

In the next figure it shows the situation in the southern Italian region of Puglia, when often, peak residential demand frequently corresponds to moments of no PV production. From the period 2010 until 2012 , there were tremendous increase in PVs installation and production energy along with the subsequent evolution of power flows at the connection point between the transmission network and the distribution network. The problem in the situation, there was no reduction in investment regarding netting between generation and demand, during the peak load resembles to literally zero PV production.

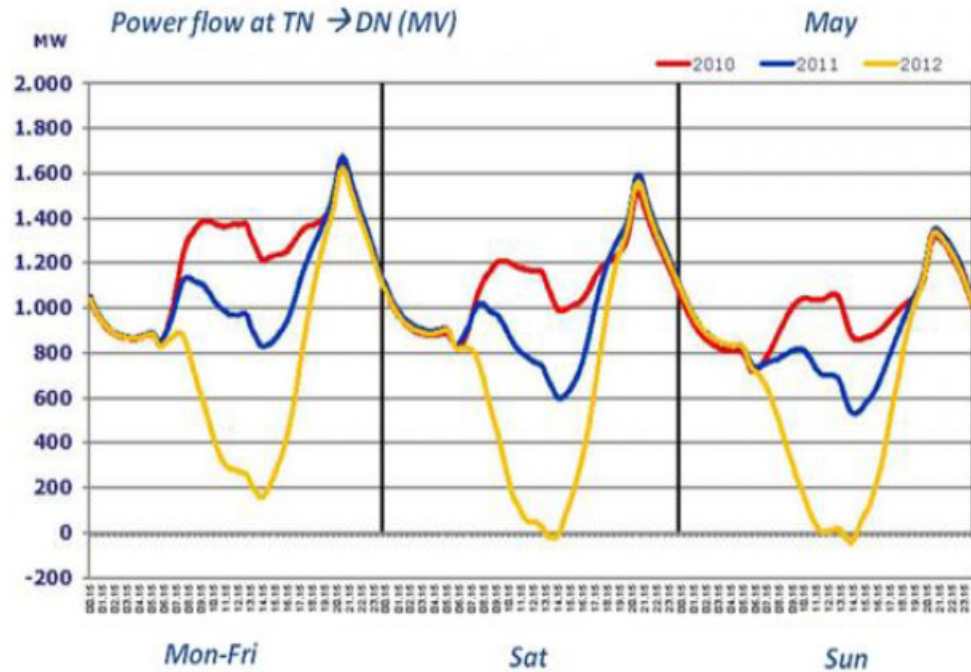

Figure 29 Power Flows Between Transmission and Distribution Network in Italy, 2000-2012 taken from EnelDistribuzione

Source: (Eurelectric(Halberg, Alba Rios, et al. 2013))

Regarding the capacity issue in terms of integrating DG, as the amount of DG is growing to be integrated in the electricity system, there is a possibility of virtual saturation. Virtual saturation is a situation where the entire capacity is reserved by plants queuing for connection that may not eventually materialise – may also occur as generator plants be firm before the final investment decision(Eurelectric(Halberg, Alba Rios, et al. 2013)).Yet, in the situation when the project is not built, DG occupies an idle capacity which may induce new grid capacity request in order to face increased costs in the situation network reinforcements are needed. Queuing, long waiting times and delaying grid connection of new generators can happen because of temporary lack of network capacity.

The development of distribution network is under DSO's responsibility regarding the new lines design and substations. These new substations or the existing ones are reinforced to enable connection of load and power production decentralization. At particular voltage level, there is possibility that DSO needs a new connection at a certain voltage level which depends on the size of DG and RES system. Third party access must be given to all customers by DSOs and also all information regarding efficient access and use of the distribution system. In European Union, the Art 32 of Directive 2009/72/EC arrange the right of DSO in refusing access to the grid only when they are able to show that they lack the necessary capacity.

b) Voltage

Voltage control is a system service managed by network operators in order to maintain voltage in their networks within limits and to minimised the reactive power flows and consequently, technical losses(Eurelectric(Halberg, Alba Rios, et al. 2013)). Generally in the electricity system, DGs are connected to low voltage networks. The security and hosting capacity of the distribution system is determined by voltage (statutory limits for the maximum and minimum voltage ensure that voltage is kept within the proper margins and is never close to the technical limits of the grids) and the physical current limits of the network (thermal rate of lines cable, transformers that determine the possible power flow) (Eurelectric(Halberg, Alba Rios, et al. 2013)).

Voltage inclines to drop because of resistance in cables when power is transferred over long distance. The consequence of DG being connected to the distribution network normally is increase of network. This situation helps the voltage within the specification over the distance and brings positive impact on the network. This positive impact is however strongly dependent on the number of

generators connected to the distribution network and their concentration: above a certain threshold, adding another DG might negatively impact the network by increasing voltage above the specifications. (Martin 2009)

HV	<ul style="list-style-type: none"> • Usually power transformers with on-load tap changers • Capacitors frequently used to control the voltage
MV	<ul style="list-style-type: none"> • No analogue values in secondary substations obtained in real time (typically analogue values only at MV feeders) • MV networks connected to HV through a power transformer with on-load tap changer Capacitors can be commonly found also in these substations to improve the power factor • Voltage setpoints specified at MV substation busbars
LV	<ul style="list-style-type: none"> • MV/LV transformers may be fixed ratio (i.e. have not tap changers) or have off-load tap changers, manually controlled. Taps selected to compensate the effect of MV voltage drops at LV levels (passive approach). • These tap-changers operate only a few times during transformers lifetime. • Sometimes capacitors are installed in consumer facilities to meet power factor regulations • New controllable MV/LV transformers are emerging but expensive

Voltage control in current distribution networks

Figure 30 Description about Voltage Control in Current Distribution Network

Source: Eurlectric(Halberg, Alba Rios, et al. 2013)

DSOs should consider voltage variations and also congestion in terms of accepting new connection of DG. The injection of DG will lead to active power which eventually is going to affect voltage profile modifications. The connection point for DG units and the relevant grid area must face the voltage increase (overvoltage) as the consequence of increasing connection of DG. Meanwhile congestion is probably happens when there are numerous of DG feed-in that connects to the system beyond its physical capacity limits. Necessary emergency actions in order to interrupt/ constrain off generation feed-in or supply must be done in the distribution network.

However, the voltage level may drop due to certain load types or increase because of small generators in low levels of the grid or by reactive power shortages. Short term abnormal voltage of current oscillation may occur as DGs are switched on or off. (Martin 2009). This situation may bring destabilizing effect on the network. Because of those situations there are some challenges regarding controlling the voltage as the number of connection of DGs increasing in the distribution network:

- a) Active power turns out a major change for voltages change especially in the MV and LV networks because technically, the effect of active power is more significant than the reactive power, therefore the lower the distribution voltage level, the higher this effect. DSOs may have difficulties in maintaining the voltage profile at the customer connection points, in particular on LV level, as active voltage control is not in place ((Eurelectric(Halberg, Alba Rios, et al. 2013))).
- b) In MV and LV networks, the active power effect may not be always, neutralised by the reactive power injections/withdrawals available in the systems. Moreover, in most countries, monitoring of grid values is missing and most DGs are not equipped to participate in system management-no active contribution of generation to network operation is expected(Eurelectric(Halberg, Alba Rios, et al. 2013))).This situation could put operational system security in danger and putting a risk to security of facilities for both customers' installations and the network

In EU, unfortunately currently in the European electricity system, especially for the case of smaller size DGS, DSOs do not have particular

system installed in order to acquire data from them. This information is needed in order to make sure the stability of the grid. Ironically in some cases, even though DSOs have no real time access to information from DG in real time, TSO could receive it. Unfortunately between the TSO and DSO, usually an operational exchange does not exist. The dilemma side of DSOs, they have to take into account distributed energy resources and conventional assets in terms of planning their networks, which arranged in EU Article 25.7 of Directive 2009/72/EC.

DSOs are subject to technical performance requirements for quality of service including continuity of supply (commonly assessed by zonal indexes such as average duration of interruptions per customer per year (SAIDI) and average number of interruptions per customer per year (SAIFI) or individual indexes like number and duration of interruptions and power quality laid out in national law, standards and grid codes (Eurelectric(Eurelectric(Halberg, Alba Rios, et al. 2013))). Moreover it is the responsibility of DSO in order to maintain the voltage quality in distribution networks such as voltage fluctuations on system within its boundary which should be considered since the in the planning process. In the planning DSOs should already choose the groups of DGs that could be connected into the grid and have access, in considering they will not contribute to any system congestion.

c) Protection

In order to prevent internal faults, defective distributed network and islanding, supplementary protection systems are needed while using DG. Islanding occurs when part of the network is still operating with the DGs delivery electricity to customers while the rest of the network has been disconnected. (Sommerville, Sawler

and Vantaggiato 2012). In terms of making sure steady supply of consumers with critical need for electricity or ensuring that the majority of the network is still operating while a section is under maintenance,(e.g hospitals or airports) islanding is really needed. Yet the problem comes from undetected islanding as network operators might undertake repair work and thus incurs significant risk for staff members.

d) Transmission and distribution losses

One of the main notions of implementation DG was giving advantages such as helping to reduce transmission and distribution losses as DGs are not connected to the transmission grid and some of them might even choose to operate as restrained plant for a client with accordingly limited use of the DG. Recent research has however shown that above a threshold (at very high penetration rate and with generators concentrated in a specific area and all of them feeding the distribution grid), the size of transmission and distribution losses goes up again(Eurelectric(Halberg, Alba Rios, et al. 2013)).

In the next figure it will show the connection between the DG penetration level and Grid losses. As the low share of DGs connected to the network, the losses drop until certain point, yet once the network gets injected with large number of DGs, grid losses tend to increase. DSOs must realize the situation that there possibility of reduction network cost in transport levels as the result of DG connection but higher costs will occur n the level to which it is connected.

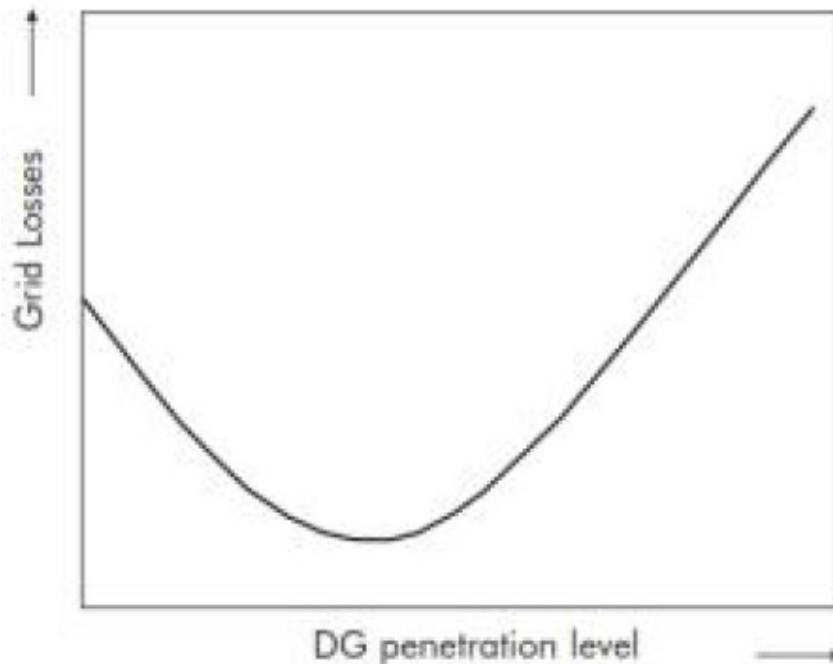

Figure 31 Relation Between The Degree of DG Penetration and Grid Losses

Source: Eurelectric (Halberg, Alba Rios, et al. 2013)

e) Lead time for connection

DG deployment needs adequate physical infrastructure like networks in order to connect sites. Limitation in the network's capacity to absorb new generation is one of the problems that DG party has to face. In Greece and Spain, there is voltage control problem in terms of connecting new units to grid

DSOs need to take into account distributed energy resources and conventional asset in terms of planning their networks. They will find difficulty when they receive application for connection which submitted at short notice and furthermore there is no information on connection to private networks. This situation is difficult to accomplish even though there is a rule that DSOs must provide third party access to all end customers and provide network users with all information regarding efficient access and use of the distribution system.

f) Ancillary Services

The integration costs, such as the amount spend on ancillary service of electricity system increases with the higher used of RES and DG. Ancillary services gives positive impact in the quality of electricity delivered which are provided by centralized generators. For example, centralized generators are requested to keep capacities in excess of peak to adjust production in case of demand surge, to hold voltage control devices. (Martin 2009). One of the consequences of increasing of DGs is that DGs will need to provide a larger share of these ancillary services. DSOs as the one who in charge with their distribution network, must provide this ancillary service especially when the integration of DG within their network its getting higher and higher.

In the European Union, ENTSO-E (European Network of Transmission System Operators for Electricity) underlined that there was a risk of frequency instability, liked to the behaviour of decentralised generation (massive trips caused by frequency increases of just 200 MHz), particularly for photo-voltaic production (Paul 2011).

Besides the technical issues mentioned above, DG's share is still negatively influenced by the drawback of the inappropriateness of regulation. For small DG units it will be hard to face entry barriers such as high degree concentration on the power markets or economies of scale of incumbents render.

Procedural barriers to network access

Delays, the longevity and complexity of authorization procedures are some of the examples barriers in order to access the network of electricity. Until July 2005, Germany was the only country that had no regulated network access. Those parties that involved in the transaction must negotiate the conditions. Industry

associations that laid down the principles and calculating grid access had to make an agreement between them.

DSOs must overcome the challenge overcome by DSO in terms of connection and access by cooperating with all relevant actors that must be involved in the connection requests analysis. Specifically they coordinate with TSOs in terms of enhancement network development. In regional basis like EU, there should regular network development plan with other DSOs in the same region.

IV.3 Lack of Participation in Distributed System Services

IV.3.1 What is System Service?

System service is recommendation specific rules consist of ancillary services, firm capacity management, security congestion management, frequency control, (anti) islanding operation, voltage control in order to increase system flexibility and better manage the electricity in integrating numerous generators into grid which offered for network operator (DSO or TSO, whom could define it in the grid code or procure it. System Services are delivered by DER to DSO in order to maximize the Out of Step (OoS) Protection for Generators and SoS(System Observation Service) in the distribution network.

It is the responsibility of DSOs to develop their grids efficiently and provide quality of service for the end users. Because of the possibility of bottlenecks in distribution grid or other technical limitations, the optimal function of electricity markets do not always occur. In order to fulfil their responsibilities in keeping the stability of the network in the numerous connection of DER/DG, DSOs require adequate new tools. It is important in this situation to optimize or steer the local load, particularly distributed electricity resources. The notion of system service should be embedded in the three different processes of DSP business which will be discussed in the part IV.3.2

IV.3.2 DSO Main Business Process

The responsibilities of recent DSOs entity in the liberalized electricity system:

1) **Distribution planning, system development, connection & provision of network capacity**

DSOs are in charge of distribution planning, system development, connection & provision of network capacity. As it mentioned before, DSOs are in charge in developing their network by designing new lines and substations. Moreover, DSOs have to reinforce the existing ones in order to enable connection of load and decentralised power production. One of the benefits that DG offers is reducing costly investment in the distribution networks (upgrade or capacity increase) by producing electricity where it is most needed. Unfortunately this situation are often not realised because of the structure of distribution network operators. Due to the fact that distribution network operators are regulated natural monopolies, they are frequently remunerated on a cost plus or rate of return basis with adjustment for reaching performance test. This situation makes DG not being favoured by distributed network operators because they do not directly have benefit from DG's penetration. Consequently, the distribution network operators would rather invest in the costly solution that offers them a safe income for example in network extension or upgrade with a guaranteed rate of return than invest in a less costly solution without gaining. Moreover, transmission network operators cannot hold generating capacities in general electricity market deregulation situation.

Network development is one of the responsibilities of DSO, including the designing new lines and substations. DSOs have to make sure that they are delivered or that existing ones are reinforced to allow connection of load and decentralised power production. Furthermore, DSO should make planning in investment on the basis of market needs. They have to deploy the infrastructure that will activate producers, customers/'prosumers',

suppliers and other service providers to meet on an open market place while dedicating them advanced tools in order to manage their grids.

Regarding implementation within their network Smart Grid process, DSOs have important roles in DGs integration in electricity system. In terms for connection of Distributed Generation, DSO has several obligations:

- 1) Knowing which one of the DGs are online and when they are working to prevent accidents
- 2) Having possibility to verify compliance with requirements
- 3) Registering all the DG in their territory area
- 4) Remote disconnecting DG to prevent damage
- 5) Defining control scheme and settings for generators connected to their grids, in coordination with the TSO

Three fundamental challenges to the deployment and development of smart grids in order to actively respond the demand market:

- a) Incentive should be given to DSOs in terms of investing in smart grids in order to manage their networks more intelligently where necessary.

The replacement of traditional grid by Smart Grid process is advisable in order to support the increasing amount of penetration of DGs. Smart Grid which help integrating DG will be part of major change in the management and control process. Unfortunately, the results of the regulatory incentives given for innovation such as smart grid are still mixed.

- b) An appropriate regulatory framework is needed to support the development of a new market model
- c) Well-functioning demand response markets require customer engagement and active participation, which will only be possible with market reflective prices, which will be discussed more in Active Demand Participation sub section

It is the obligation of DSOs to serve third party access to all end customers and furnish network users with all information they require for efficient access and use of the distribution system. In the European Union, the DSOs are able to refuse access to the grid only when they can prove that they lack the necessary network capacity (Art. 32 of Directive 2009/72/EC). Therefore, the decision about the connection and access in their network should be supervised by DSOs, since they know better about their own grid.

2) Connection and Access

DSOs have to manage distribution network operation / management and support in system operation. The system security and quality of service are supposed to be maintained by DSOs in the distribution network. This responsibility includes control, monitoring, and supervision, and managing scheduled and non-scheduled of outage. DSOs have to support the TSOs, who are generally are responsible of overall system security, for example through load shedding in emergency situations.

These are main factors regarding connection and access that should be considered by DSOs :

- a) Power flow management : Ensuring high reliability and quality in their networks. In terms of continuity and capacity of the networks, DSOs are subject to technical performance requirements for quality of service inclusive continuation of supply. The continuation of supply commonly are assessed by zone indexes such as average duration of interruption per customer per year (SAIFI) or individual indexes like number and duration of interruptions and power quality laid out in national law in European members, standards and grid codes. (Eurelectric(Halberg, Alba Rios, et al. 2013)). DSOs are incumbent about voltage quality in distribution networks such as maintaining voltage fluctuation on the system within given limits. The DSO has to make sure that networks are designed to maintain these standards

regardless of power flow conditions during the planning of the network. DSOs are responsible for undertaking switching action so that adequate supply quality is maintained especially in the situation of network faults, planned outages or other anomalous events. Moreover they have to take care of automation or remote switching in order to make sure fault isolation and restoration of supply

- b) Voltage and reactive power: electrical installations of connected network quality impact the quality of the voltage and add complexity and the need for both real-time measurement and mitigating resources such as on-load voltage control and strict network connection criteria. In EU, there is no operational exchange between the TSO and DSO. TSOs are in charge for the level of supervision, control, and simulation in HV (High Voltage) distribution networks in their networks. TSO has ability to manage electricity balance system by asking the generator to send their electricity dispatch schedule at the transmission level. Moreover, while TSO is able to receive information from DG in real time in some cases, DSOs have no access to this information. DSOs have no systems installed for acquiring data from DG of smaller size in particular (Halberg, Alba Rios, et al. 2013).The main problem that occurs in a system with high DGs penetration is that DSOs have to know more information about DG forecast, schedules and active dispatch to aid with real time or close to real-time management of distribution including local network information that will be substantial for operation of their networks.

3) Facility and equipment operation and maintenance

Operate a secure, reliable and efficient energy supply network. It is the responsibility of DSOs to received generated power-in in the distributed network and any energy form the transmission system to distribute it to the retail or end user of electricity. Therefore, DSOs have to connect any generating units that have passed the certain

condition indiscriminately. Distribution network operation/ management and support in system operation.

DSOs are responsible for maintaining the system security and quality of service in distribution networks. The responsibilities are controlling, monitoring, and supervision, as well as scheduled and non-scheduled management. They also have to maintain all the operations directly implicating their own customers. They have to help TSOs in terms of overall system security, when necessary in a predefined manner, either automatically or manually for example via load shedding in emergency situations. In EU, national regulations define about system of cooperation for intervention in generation and demand in cases of system security events. EU-wide network codes (operational security, balancing, congestion management) arranged a common basis for these rules.

a. Continuity and capacity

DSOs are responsible for quality of service including continuity of supply and power quality as laid out in national law, standards and grid codes. These technical requirements are generally assessed by SAIDI (zonal indexes for average duration of interruptions per customer per year) and SAIFI (average number of interruptions per year) or other individual indexes like number and duration of interruptions. DSOs are also accountable for voltage quality in distribution networks by maintaining voltage fluctuations on the system within given limits. They have to make sure in terms of network planning that networks are designed to maintain the give in standards limit. Also, DSOs have to take responsibility to switch actions so that adequate supply quality is maintained, in the situations like network faults, planned outages or other anomalous events. While to date this has been rather static, increasing automation or remote switching will need to be undertaken to

ensure near real-time fault isolation and restoration of supply (Eurelectric(Halberg, Alba Rios, et al. 2013).

In the passive distribution networks, DSO uses “fit and forget” approach in order to resolve all issue in their area territory. The resolving approach is done at the planning stage, which could tend to oversized network. Because of the local consumption use electricity produced by DGs, there is possibility that firm capacity (firm grid connection and access), is not used. In terms of requiring low flexibility, control and supervision, passive distribution network approach offers those benefits, in the condition that the distribution network has only very low DER connection. The uneconomical drawback of this approach is the system complies with all contingencies once DER penetration rises without additional investment in basic network infrastructure.

Energy losses

Generally DG brings positive impact on minimizing energy losses as long as it still has low penetration rate and low concentration. This positive impact could bring profitability to DG entity. Every country has its own policy in order to handle energy losses. In countries such as Italy, the network operator pay for the loss to the DGs connected at the transmission level (Martin 2009). On other countries like France, the operator has incentive in terms of prompting DGs to enter the market. Thus, the operator pays for the losses through the purchase of electricity to centralized generators (Martin 2009). Although the network operator will favour this situation, because he will get financial gain in letting DG enter the market and reduce the network losses, centralized generators will not get less

advantageous. Furthermore, the relationship between centralized generators and network operators will be affected by this circumstance. When both, though legally independent from one to the other, are owned by the same entity, the operator might not be willing to favour the DGs (Martin 2009).

b. Voltage and Reactive Power

DSOs have to make sure of voltage quality and be responsible for the network users' actions. If a situation needs extra attention, they need to add complexity and the need for both real-time measurement and mitigating resources such as on-load voltage control and strict network connection criteria. In EU region, there is standardization (EN 50160) that arranges the maximum and minimum voltage at each service connection point have to permit an undisturbed operation of all connected devices. The standardization requires the range of the voltage for each connection should be of $\pm 10\%$ of the rated voltage under normal operating conditions. In some countries, compliance with these or other specified national voltage quality requirements that can be even more restrictive represents part of DSOs' contractual obligations and quality regulations, moreover network operators are required to compensate customers in case the overall voltage quality limits are breached (Halberg, Alba Rios, et al. 2013).

This voltage issue cannot be done passively, because it concerns the quality of power being served to the customer which is the responsibility of distribution network in the liberalized market. Regarding this voltage issue, there is possibility that DSOs require a new connection at a particular voltage in terms of connection of DGs because DSOs have responsibility in developing their network.

Therefore since the planning stage, the DSOs should have already considering the amount of DGs and all their technical issues that can get connection and access to the distribution network, and moreover any reinforcement which might needed in the future.

The voltage level would depend on the size of DG and RES system. The responsibility are including designing new lines and substations, and ensuring the delivery of them, making sure that the existing ones are reinforced to enable connection of load and decentralized power production. DSOs must make sure the voltage quality in distribution networks which means they have to maintain voltage fluctuations on the system within given limits. The networks needs to be designed to maintain these standards regardless of power flow condition which must be considered in network planning by DSOs.

Current Situation of Traditional Design of Distribution Networks

Regarding to fulfil the three concept responsibilities mentioned above, generally most of the DSO still use traditional design in operating their distribution network. Under the paradigm “networks follow demand”, their primary role was to deliver energy flowing in one direction, from the transmission substation down to end user. This approach makes use of very few monitoring tools and suitable for distribution networks with predictable flows (Eurelectric (Halberg, Alba Rios, et al. 2013)).

Every country has its own policy regarding development of distribution networks. Voltage rate levels are usually distinguishes as LV, MH or HV. In most countries, monitoring of grid values is missing and most DGs are not

equipped to participate in system management-no active contribution of generation to network operation is expected (Eurelectric (Halberg, Alba Rios, et al. 2013)). There is a possibility that DSOs have difficulties in maintaining the voltage profile at the customer connection points, in particular on LV level, as active voltage control is not in place. MV and LV networks are mostly rather passive are the responsibilities of DSOs which makes them lack network visibility and control. As a result, operational system security may be endangered and security of facilities (both customers' installations and the network as such) put at risk.

DSOs in European Union region, need to take into account distribute energy resources and conventional assets when planning their networks, which arranged in Article 25.7 of Directive 2009/72/EC. In order to see the hierarchy of traditional design of distribution network in most European Union member the figure below will show us.

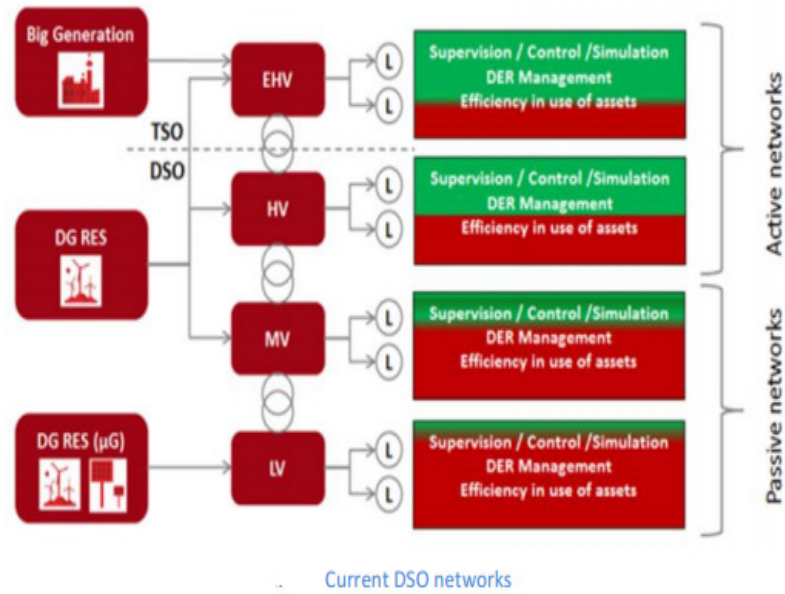

Figure 32 Distribution Network in most European Union Members

Source: Eurllectric(Halberg, Alba Rios, et al. 2013).

As we can see from the figure, the lower the monitoring level, the lower the operational flexibility. For more detail information we can see from the table below the description of the traditional distribution network

HV Network

- Also called sub-transmission
- Are quite similar to transmission networks
- Topological network is meshed
- Operated as radial or meshed depending on the situation
- Are operated in a similar way all around Europe : N-1 or N-2 contingency criteria
- Has monitoring level very high
- Can be supervised and controlled by DSOs from control room centres

MV Network

- Has different characteristics with respect to urban and rural grids
- Mostly, meshed topology
- Operated either as meshed (closed loop) or radial (open loop)
- Mostly located in urban areas which have high density of loads and relatively high demand
- Can be monitored, control remotely
- Can have automated protection/fault sectionalisation

LV Network

- Usually radially operate
- Similar to MV networks
- But have different characteristic in its urban and rural area
- Has less proportion of monitoring and control than MV
- Relies on aggregated information from substation in terms of measurements
- Are only available with a significant time lag.

The certain type of RES that DG uses as resources brings a challenge either to system balancing or local network operation. The security and hosting capacity of the distribution system is determined by voltage (statutory limits for the maximum and minimum voltage ensure that voltage is kept within the proper margins and is never close to the technical limits of the grid) and the physical current limits of the network (thermal rates of lines, cables,

transformers that determine the possible power flow) (Eurelectric (Halberg, Alba Rios, et al. 2013)).

Voltage variations and reserved power flows can drive out either distribution defined legal or physical operating boundaries. Injection of active power tends to incur voltage profile modifications which eventually lead to overvoltage for DG units, as the result of voltage increase. The possibility of reserved power flows from, which is flows from distribution to transmission, is because DG production surpass local load. Impact on voltage profiles could be stronger as the more local production surpasses local demands.

Particularly on LV level, there is a possibility that DSOs find difficulties in terms of maintaining the voltage profile at the customer connection point because the active voltage control is not in place. In most countries, monitoring of grid values is mission and most DGs are not equipped to participate in system management-no active contribution of generation to network operation is expected as result, operational system security may be endangered and security of facilities (both customers' installations at the network as such) put at risk (Eurelectric(Halberg, Alba Rios, et al. 2013)).

The integration of DG on large scale will however require the distribution network to be active in the sense that they will have to manage the flow coming from centralized generation through the transmission lines, forecast the levels of output from distributed generators (and especially peak generators), collect information, and devise start-up

producers in case of system, automation. (Martin 2009). The development of management and control procedures are needed in order to make sure a fast and safe operation, in order to handle the increased level of complexity. Either relying on a centralized control entity or several local controlling entities coordinated together is a possible choice in order to fulfil the change in network control and management. One of the examples of the importance of communication between DG owner and DSOs is when application for connection are submitted at short notice and DSOs do not receive information on connection to private networks.

In the next figure we will discuss more about the situation in the traditional distribution network, which also has been shown in figure 28. In Figure 28 we can see that the most of the LV and MV networks are Passive Network.

Passive Networks

In transmission level, the coordination between the centralized generators and the adjustments in outputs were done. Because of the characteristics of electricity that cannot be restored, centralized power system is organized so that supply resources are operated to follow demands under all situations. It is operated by a single dispatch entity that commands and operates all assets in an optimized fashion according to a consistent set of values.

The coordination that happens in transmission cannot be found easily in the distribution network especially since the connection of DGs getting higher and higher. Theoretically, DG should take part in the security of supply, power quality,

reduction of transmission and distribution peak load and congestion, reduced need for long distance transmission, prevention of network capacity, network investments' suspension and reduction in distribution grid losses through providing active power to the load and managing voltage and reactive power in the grid.

On the other hand, in a distributed system customer demands interact with and respond to supply conditions and capabilities. Originally, distribution networks have been less sophisticated than transmission network because they have passive role in terms of passing energy from the transmission networks to the customers. Moreover, in a system with high levels of distributed energy resources there will be a variety of assets operated by many different owners and operators acting to serve their own interests rather than optimize the electric system. The other problem is DG is not always located close to load and mostly DG production is not non dispatch able which makes DG cannot control its own output. Consequently, the power produced by DG does not always concur with demand in the stochastic regimen and DG does not generate supposedly when distribution network is constrained such as peak time. Basically DG does not have responsibility for contributing in meeting the demand especially in the peak. And such situation is a problem too, when distribution network must give the service to meet the demand.

Therefore because of DG production profiles, capacity challenge occurs in terms of integrating DG in to Distribution networks. The issues are location of DG which is not always close to load and incapability of controlling its

own output, due to not-dispatch able DG production. This situation leads to the inability of DG production to meet the demand (stochastic regime) and DG does not necessarily generate when distribution network is in restricted condition for example peak time. Additionally, DSO has to take into consideration power injection to higher voltage levels when the local capacity exceeds local load. This circumstance induces challenges either to distribution network development and operation.

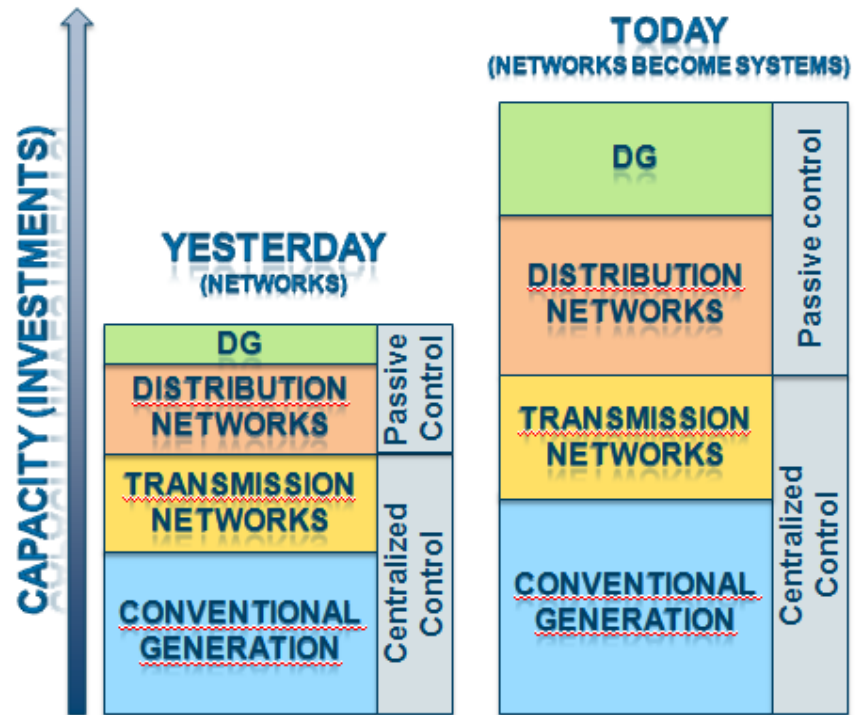

Figure 33 comparison the design of the Distribution Network with Less DG penetration and with today's condition

Source : (Fenix Project (Trebolle 2011))

As it mentioned before, passive network used “fit and forget” approach which suggests settling all the problems occur in distribution network at the planning stage, which has the potential to an oversized network. In this situation, because of the local consumption of the electricity produced by DG, there is possibility the firm capacity (firm grid connection and access) given by DSOs is not fully used anymore. This approach has the advantage of requiring low flexibility, control and supervision, but is only possible for a network with very low DER penetration (Eurelectric(Halberg, Alba Rios, et al. 2013)). This approach is less economical, since very tremendous investment in its basic network infrastructure must be done due to anticipating all the contingencies once DER penetration rises.

Just like it shown in the figure 29 the growth of DG and also electricity through times. The situation when in the past and the recent days is the same, Distribution Networks and DG are managed under Passive Control. With the growth of DG now days, there is other option than improving the control in the distribution network in order to arrange the connection and access for DG because it not possible in the future that DG will displace a significant amount of energy produced by large conventional plant. Nevertheless, electricity networks and conventional generation will need to continue the provision of system support services required to maintain security and integrity of the system if the condition in the network DG and DSM are not integrated in system operation. This situation will lead to incapability of large penetration of DG to replace the capacity of conventional plant network which shown in the

figure 29. The increasing in capacity of both transmission and distribution networks are needed in order to maintain the traditional passive operation in as DGs make a significant proportion of penetration, which tends to be connected to distribution networks.

Reactive Network Integration

Some countries with high share of DGS apply this reactive network integration which known as “only operation” approach. In this approach, the regulation arranges that there are restrictions in terms of connection as much as possible DGs into the network. Both load and generation are restricted in order to handle the congestions (or other grid problems) in the operation stage. The problems occurs in term of arranging the remuneration for those DGs as they are being restricted during many hours per year and could lead to negative business case for DG. Already today, some “front-runner” countries with high DG penetration levels can be considered as having reached the interim “reactive network integration” stage at which DSOs solve problems once they occur (Eurelectric(Halberg, Alba Rios, et al. 2013)).

IV.3.3 Why System Services?

The proposed solution for supporting 3 main business process of DSO is system services at the distribution level which are arranged in grid codes and ancillary services. Such services includethe participation of decentralised generators in voltage and reactive power management, distribution network capacity management and congestion management and information exchange between TSOs, DSOs and DER (Distributed Energy Resources)(Eurelectric(Halberg, Alba Rios, et al. 2013)).In terms of ancillary services, DG could contribute by improving the quality of services provided through voltage control. By connecting a DG to a

low voltage network would enable it to reduce the drop in voltage over the distance, which will provide additional peaking power capacities. Unfortunately, this potential service is not a source of revenues for DG under mostly current regulation in the liberalized market

As it mentioned before the main goal of the system services is to keep the integrity, security, and quality of the system work properly. Users connected to the system have right of distribution system service which provided by network operators in order to make sure power quality and the stability of the distribution grid are supplied. The cost of distributed system services are paid by grid users, generally through tariffs.

These are the condition that is expected from DGs as the system services being implemented in the distribution network:

- 1) The equipment and its protective relays must be able to resist voltage dips
- 2) Preventing islanding
- 3) Separating metering for production and consumption
- 4) Bearing the same cost as other generators including adequate connection fee.
- 5) Being registered with DSO and
- 6) Can be remote disconnecting by the DSO

By enabling the offering of market products and meanwhile ensuring the security, integrity and quality of supply, DSOs are going to take part as market facilitators at operation timescales. In the situation when market products cannot meet distribution grid security standards, new Demand Side Management System (DSM) services will be required. DSM is used with the aim to reduce energy consumption and improve overall electricity usage efficiency through the implementation of policies and methods that control electricity demand (Halberg, Alba Rios, et al. 2013). It is expected that DSM is able to bring DSOs a new system services either for long term planning or in the operation (short term planning). Normally power companies have a task of DSM in order to reduce or remove peak load, as the result deferring the installation of new capacities and distribution

facilities. Based on this circumstance, DSOs could solve grid constraints through demand flexibility by having new agreements with suppliers/ large customers.

V. Regulatory recommendations

In this chapter, the solution recommendations regarding the challenges that have been revealed as the motivation of the thesis and has been further discussed in chapter IV. Any possibility of recommendations for the each problem will be revealed in sub chapter V.1, V.2 and V.3.

V.1 Recommendation for Market Access and Incentives Schemes for DG:

As we have already known, there are numerous of DG technologies resources either from RES or CHP, and furthermore in chapter IV we have mentioned that this DGs concept are still new if we compare to centralized generations which have been mature in the electricity market. According to learning curve which has shown in chapter IV, the new technologies will still cost a lot in order to survive in the market and compete with the incumbent player, therefore the government still need to “help” them by giving support scheme. The recommendations to give these supports schemes

- a) The support scheme should be decreasing as the technology become mature through times

The regulation should set up time frame that for giving the support scheme given by the government. As we can see from figure 33, as the cost of the DG decreases through times, the technology will become mature and until certain time it will able to be commercialized in to the market and be manufactured in the large scale. The government need to reduce the amount of fund given to this technology and introduce the other support for example industry partnership between the same

technology producers, until this DG will become mature to the market and ready to compete to other type generation either centralized generation or DGs technology. After on technology has been mature, the regular fund that usually being budgeted annually can be allocated to other new technology or certain technologies that have not been mature yet. In every country has different prioritize of technology especially in terms of RES technology which really depends on the natural resources of each country.

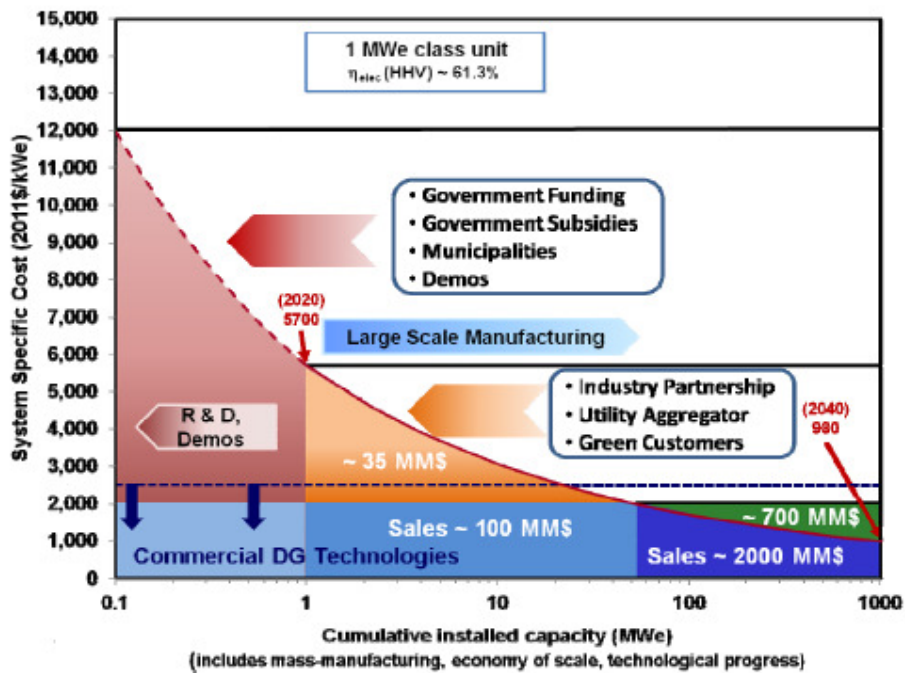
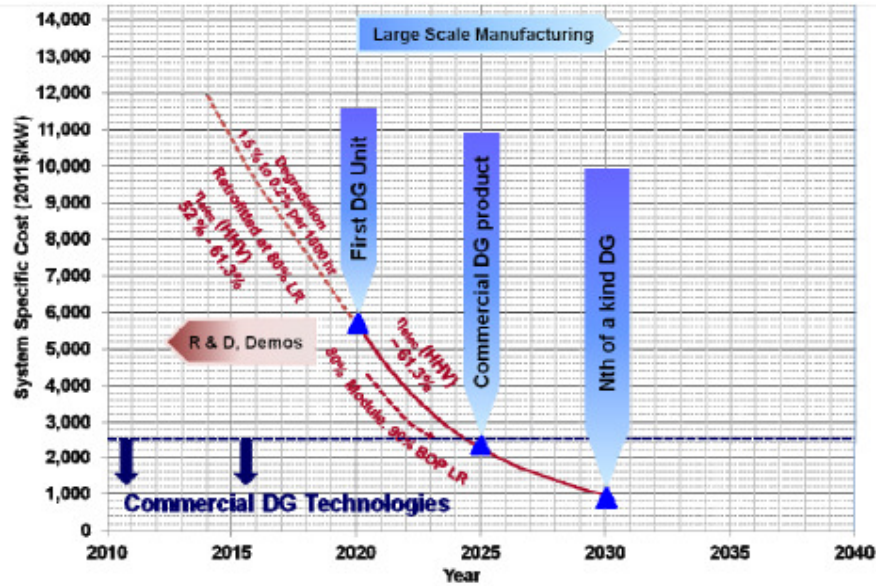

Figure 34 Proposing Decreasing of Support Scheme Through Times

Source :(Krulla, et al. 2013)

- b) Making more market based oriented support scheme based on production will be better to be applied for the support scheme rather than investment. This policy should be applied not to the new entry technologies of DG in order to support their position in the market first

before facing the real competition market. However as time goes by and the cost of the production of the certain type of DG has been decreasing, this policy should be applied to them. By introducing market based oriented support scheme like quota or bidding, the DG owner will compete each other in order to have the most efficient cost. This cost will be eventually to passed to the customer, who will in any even be required to fund the additional costs through taxes or through increased consumer prices. It also will be easier to make it transparent to the society, rather than just giving an amount of fund to certain technologies of DG. This transparency could be or at least part of it being exposed to the price dynamics of supply and demand, in order to give price signals to the society.

c) Giving incentives to DGs that use RES technology

As we concern for our environment, and also for those regions that have RES target like in EU, it is better to give prioritized to DG using RES than other technology or even fuel generation. The price based support scheme or quantity based support schemes. The other way in order not to introduce differentiation among DG using CHP, the producer that used RES technology should get incentive for example price premium or allowance in investment. This incentives should also consider the mature of the technology itself. Again as the technology of RES becomes mature in the market, a market based support scheme should be applied to this RES in order to make sure cost-effectiveness.

d) Making co-ordination with other countries in terms of RES development in order to reduce cost of RES

Especially with the region with RES target like EU, coordination within countries will help them in order to do economies of scale and reduce of cost in terms of RES development. This situation will reduce the dependency with financial support scheme like feed-in tariff, which

eventually will not increase the electricity tariff to the customer. The players that are interested in investing in RES will increase as the reduction of cost production which eventually supports the integration of DG in the distribution network. This coordination will also make transparency in administrative which is needed to have coordination between energy companies from different countries.

- e) The support scheme should be given to the technology that have potential to be mature in short time or not prioritizing the immature technology.

Since the government has limitation of fund to be distributed to DGs development which consist different kind of technologies. However since the goal is promoting the penetration of DGs in the distribution network, the government must choose the certain candidates to receive the support scheme either from state budget or access tariff to the network. The government should define into two groups for the available funds. One group with more mature technologies will have the bigger percentage while the other have smaller percentage of the fund. The bigger part will be divided to each project of DG mature technologies which consist of more player while the smaller part will be distributed to small number of player as well.

- f) Recommendation for Net Metering Policy

Net Metering Policy is able to encourage DGs projects by making them more financially viable by having DG owner operators able to sell excess electricity back to the utility. This policy can also be used to promote certain type of DG technologies for example giving the DG owners using RES technology to transmit the excess electricity back into the main power grid and in return, they will receive either credit or payment from the utility. There is an effort to alter the design or operation of the electricity market in order to intensify the connection of DG technology to the distribution network. Net metering, which pays small generators retail electricity prices for power supplies to the local grid, is an example of

support policy sometimes offered to household customer producing power with PV (Fraser and Morita 2002)

V.2 Recommendation for Connection and Access Challenges:

a) Recommendation regarding the operation of non firm connection

Since the DGs have variable of technologies types it is recommended to use access and connection no firms' variable. In this type of connection there no need guarantee the full export of the generation capacity to the distribution network. Especially for the region that has many DG with RES resources like wind, wave and tidal with their high unpredictability and intermittency energy. It makes the nameplate capacity is restricted. Moreover, by having non-firm connection, it will not only be able to easier to avoid the interruptions but also open opportunity to variant resources. Using the non-firm connection the energy produced by DGs could be dispatched if the distribution system is able to accommodate their output, yet there is no compensation in the situation it cannot be dispatched. Until the DGs in the distribution network are integrated totally and distribution network could work properly non-firm connection is used. In the future when the distribution system is reinforced whether it is LV, MV or HV and also can facilitate more capacity, the firm connection can be offered.

b) Recommendation regarding the charges for the connection and access

In order to apply the non firm connection as it is suggestion, shallowish connection charging policy should also be recommended to support the integration of DG in to the network. Shallowish charges will offer an intermediate approach between the shallow connection charge and deep connection charge. In order to support the integration of a loft of small DG units especially located in the LV network, there should be a trade offbetween providing incentives for the optimal and cost-effective

location (offered by deep connection charges) of new DG and facilitating entry for small-sized DG operators (offered by shallow connection charges). In terms of gaining economic signal for DG integration, shallow connection charges will be recommended as the best approach for :

- 1) Reducing the entry barriers especially for those technology that become prioritize to be mature technology
- 2) having simple calculation and transparent one, especially for evaluation the support scheme evaluation
- 3) giving lower transaction costs for DG promoters

Due to the complexity situation brought by the a lot of DG connection, shallow connection could be less attractive for DSOs. Moreover DSOs need a clarity regarding mechanism to recover network reinforcements related to DG connections. The DGs owners will be charged to pay only for sole use assed that needed for their connection. Moreover, system charge is withdrawn from DGs, will recover the remaining network reinforcement. Therefore DSOs could be compensated through system charges for any costs incurred by network reinforcements. It is recommended that system charge should fulfil these conditions:

- 1) Reflecting the cost used in order to provide the network user with network transport and system service
- 2) Making sure full recovery of the DSO's total acknowledged revenues.

The consequence of this shallowish charge, there is possibility of positive or negative system charges, must be paid by DGs on their impact to distribution network. It is recommended to differentiate DG system charge by time of use and voltage levels such as :

- 1) Giving incentive to any DG connections at lower voltage levels, where there are more probability of energy losses reduction and delay system reinforcement

- 2) Promoting higher production at local peak hours, in the time-of-use differentiation for meeting the local supply and demand in local area.
- 3) Focusing on bringing down network utilisation and losses at peak load time by using time-variable system charge.

c) Recommendation for the criteria of protection

In terms of disconnection policy, it is recommended to avoid it in order to encourage the integration of DG. With non firm connection DSO should be able to interrupt the export of the capacity under certain condition which arrange in the agreement between DG and DSO. Therefore, it is likeable to prevent the major condition such disconnection after this agreement. On the contrary, through times, the DSOs need to develop networks that provide sufficient flexibility and capacity to the connection of new loads and generation by having more information regarding the DGs within their network.

V.3 Recommendation Lack of Participation in Distributed System Services

a) Recommendation Active System Management Approach

As we have mentioned before the evolution of Distribution Network from Passive Network until Reactive Network Integration which found now days do not bring a solution in terms of integrating numerous of DGs connection while still keeping the stability of the distribution network. There should be another approach that gives the DSOs more privilege and responsibility in order to manage their own networks. For answering the next step that should be taken by DSO, it is recommended the Active System Management.

As we can see from the figure 30, the next step of approaching in adapting with the growth of DG penetration in the future is Active System Management. In order to make changes in the connection and access challenges, the first condition is Distribution network should be transformed from the passive network to more active one in order to accommodate to growth of DGs connection. The networks should not be unidirectional flows again from transmission to final customers. The DG penetration should be predictable in the distribution network and increasing the level of monitoring of MV and LV which have potential of congestion if it is done for supporting DG increasing number. Fit and forget approach cannot be applied any longer since the issues in the distribution network should be solved not only in the planning stage but also during connection & access and operation & management of distribution network.

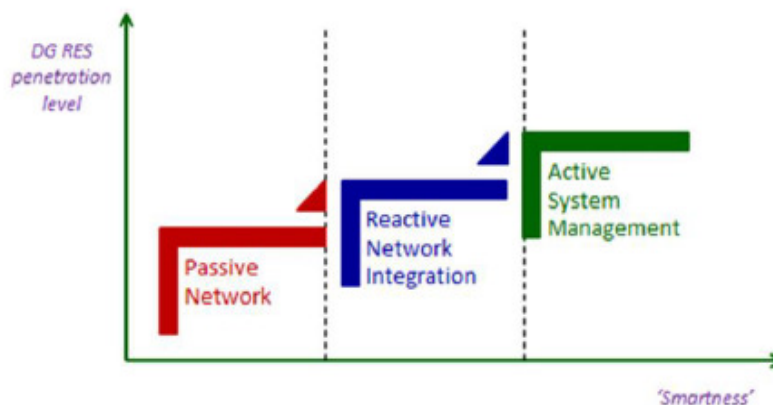

Figure 35 Three-Step Evolution of Distribution Systems

Source:Eurelectric(Halberg, Alba Rios, et al. 2013)

With Active management approach distribution networks' operational planning will be similar to transmission network in order o support the high DER shares so that energy and incentivise dispatch in a way that appropriate with the network. As the DG connection increasing, a regulation should arranged an enhanced capacity planning and possibility

of improved congestion management at distribution network which will be available at different times and location for all parties, without losing the network stability

a.1) Recommendation in the DSO Planning Business process

a.1.1) Recommendation DSOs Active Demand Management

Active networks support the integration of DG into the distribution network by enabling the connection of large number of dispersed generation and to run parts of the distribution network in islanded mode. Active Network serves demand control and protection methods in order to run the system in a safe and reliable condition. The active approach would allow for interaction between planning access & connection and operational timeframe. The need of investment in the distribution network can be reduced by applying this active approach at different levels of connection firmness and real-time flexibility.

In terms of planning DSOs have to decide on the most efficient investments in order to cope with the forecasted future demand and the connection requirements of new distributed generators.(Eurelectric(Halberg, Claxton, et al. n.d.)). Under a business-as usual planning approach the grid development follows (estimated) demand; resulting in oversized, infrequently used distribution assets-hardly an optimal approach the grid development follows (estimated) demand, resulting in oversized, infrequently used distribution assets-hardly an optimal approach (Eurelectric(Halberg, Claxton, et al. n.d.))

Active Networks are possible evolution of the current passive distribution networks and may be technically and economically the best way to initially facilitate DG in liberalized market (Karkkainen n.d.). Active network has role to become a facilitators in order to

serve the increased penetration of DG and demand-side resources which are established on new ICT and support a strategy to actively manage the network.

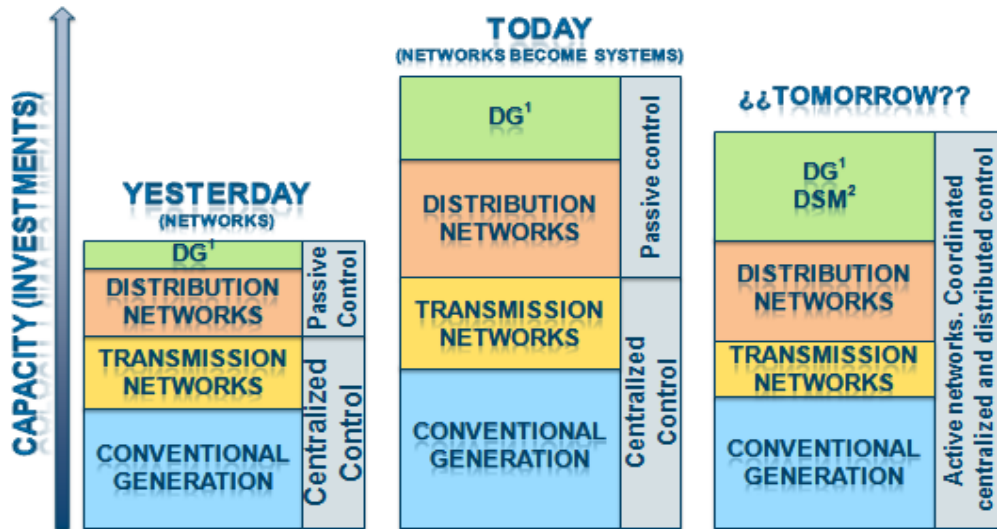

Figure 36 The Capacity Evolution of DSO in Business from Yesterday, Today an Tomorrow's plan

Source : (Fenix Project (Trebolle 2011))

In order to support the integration of DGs in the distribution network, DSO needs to have active role to know the demand side within its network. Therefore it is recommended for the DSOs in their planning business process to integrate DG and DSM into networks. As we can see from figure 31, there is possibility for DG and DSM to have the responsibility of delivery of system support services which is the role of central generation right now. By having the DSM information in the local area, DG will able to fulfil the supply without depending again with the energy produced by central generation, by its controllability reducing the capacity of central generation. The active network management will enable this situation which will make a change from traditional central control philosophy to a new distributed control paradigm, because of the establishment of ICT and also Smart Meter in order to gain

the demand information. By implementing the smart meters, the DSO will also have the pattern of usage of the local demand, and the price signals.

a.1.2) Recommendation for DSO to cooperate with Suppliers and System Services between them

Among the suppliers themselves, this new model should encourage market competition and give attention in business opportunities, and in the same time secure DSOs the necessary operation instruments (grid codes and ancillary services) to maintain grid stability.

The Collaboration between Suppliers and DSOs

The new design of demand response should include well-functioning markets with products and services for customers based on both technical and price signals, and enabling them to actively participate on a voluntary basis in the market (Eurelectric(Halberg, Claxton, et al. n.d.)). Furthermore, new arrangement between DSOs and suppliers are reflected in the grid codes and ancillary services in this case. The contracting of the customers (including DER) for maximising the utilisation of distribution assets in planning and operation timescales where locally needed should also be included in the arrangement.

This table below show the possible arrangement between DSOs and suppliers :

OBJECT OF AGREEMENT	PURPOSE	RESPONSIBLE ACTOR	SERVICE/PRODUCT PROVIDER
Provide customers with information on energy consumption & related cost	Enhance customer awareness and their active role in electricity markets	Supplier	Supplier
Balance of demand/supply in the transmission grid	Optimise demand and supply to balance the grid	TSO	Balance responsible party
Balance of demand/supply portfolio at balance responsible level	Optimise demand and supply to ensure global system flexibility	Balance responsible party	Supplier/large customer
Security congestion management (short-term)	Operate the grid within the security standards	DSO	Supplier/large customer
Firm capacity management (long-term)	DSO planning purposes; optimise demand and supply with a view to using assets most efficiently	DSO	Supplier/large customer
Voltage control	High quality of service	DSO	Supplier/large customer

Figure 37 Arrangements between DSOs and Suppliers

Source :Eurelectric(Halberg, Alba Rios, et al. 2013)

From the figure above it depicts that in the Active Management Approach, the DSOs are able to make an agreements with DERs in terms arranging the system services between them. These services between the actors involve are expected to cover planning issues such as fir capacity management and operation issue such as frequency control, voltage control, the black start capability, the islanding operation, and congestion management.

a.2) Recommendation for the Connection and Access for DSO

a.2.1) Increasing the communication between DSO and TSO through different time frames

Interaction between planning, access and connection and operational timeframes could be realized by implementing the active approach. Investment needs can also be fulfilled by implementing different levels of connection firmness and real-time flexibility. The existing hosting capacity of the distribution network can be used more optimally if other options including ICT, connection & operational requirements guaranteeing adequate performance of DER towards the system such as through grid codes and market based procurement of ancillary service from DER are considered (Eurelectric(Halberg, Alba Rios, et al. 2013)). In order to improve the lacking of DSO role in connection and access, DSO should interact with TSO at different time frames.

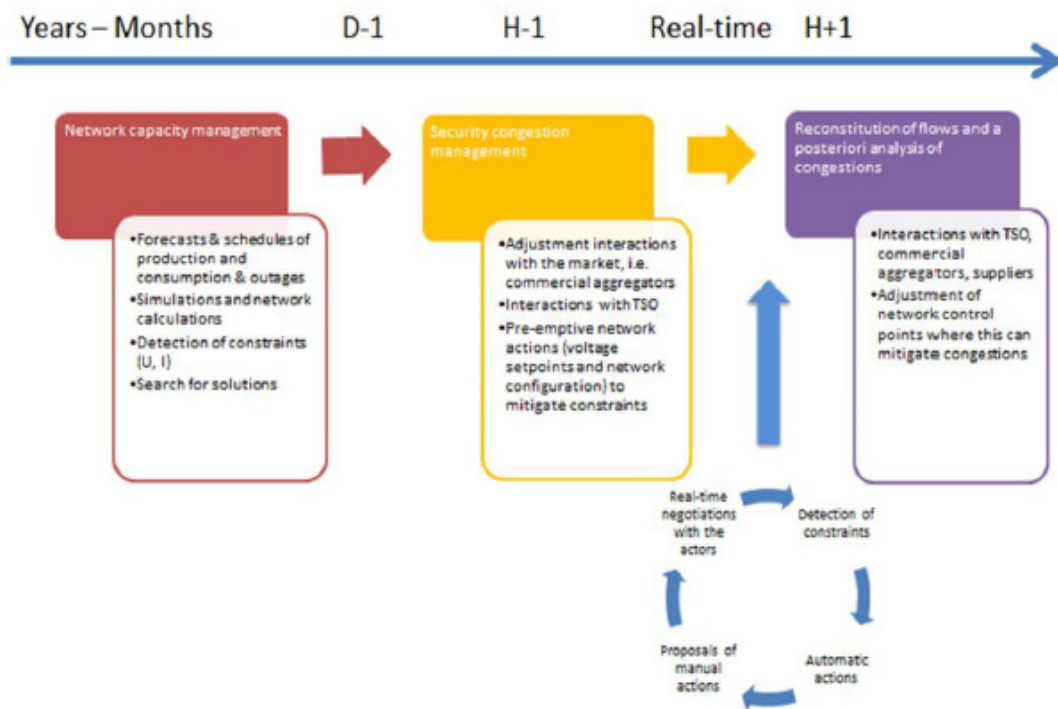

Figure 38 DSO interaction with TSO through several time frame

Source :(Eurelectric(Halberg, Alba Rios, et al. 2013)).

From the picture above we could see how DSO interact with TSO through several time frames in order to solve manage the congestion. This communication is recommended for the network development coordination between them too. Each country will have its own arrange in order to make this coordination possible. DSOs should have active system management approach that allows them to be able to integrate as maximal as possible the DERs in their network. This approach will help the DSOs to make the most of the existing grid while still fulfilling the security standards and enabling DER to find the proper condition for their business plan in also the most cost effective way. This communication will also make the possible market-based network capacity management by having open commercial tendering processes or optional variable access contracts in order to accommodate large amount of DGs and integrate them to the distribution network. This recommendation has goal in order to avoid the cost as the result of any curtailment in order to overcome the congestion.

a.2.2) Building the DG based on DSO Recommendation

Obviously the distribution operator knows better about its network because it has most access to information about where the optimal locations for DG are. DSO is the only one who can develop the network in a coordinated, system-wide manner. Third party of DGs will be hard to compete in the distribution network if it is allowed to DSOs to win only DG production. One possible solution to this ownership /unbundling dilemma is for DSOs to tender for DG capacity at points on the network that the DSO knows to be the most in need of DG. (Khoe, What Are the Regulatory Challenges Facing Distributed Generation? t.thn.) Optimisation of network capacity through improved consideration of DES in network planning would be encompassed by Network capacity management. DSO needs to

have ability in advance to identify the areas where the network problems could occur with active approach as explained in the following points:

a) Variable Network Access

Variable network access contracts as a new network access options
Variable network access rights could be offered as a discounted connection contract for generation customers, with pre-defined mechanisms for DG to reduce their output to a predefined limit in frequent situations, expected only for few hours per year (Halberg, Alba Rios, et al. 2013). Network capacity will be more efficient if only several hours of re-dispatching per year are needed to limit peaks of production. Those peak hours will be treated by additional DG output according to schedule because of higher installed DGs capacity until to a certain point where the cost of net losses and curtailed generation become relevant to justify network reinforcement

In many jurisdictions variable access is precluded by obligation to compensate generators for any energy they are not allowed in many jurisdictions (Halberg, Alba Rios, et al. 2013). Frequently, curtailment is possible in order to deal with short duration restrictions. However it is not permanent condition and grid will adapt automatically like triggering network reinforcement if this issue is considered economically justifiable by the connected parties or even DSO.

b) Tendering for a flexible services

Tendering is an alternatives service especially during period of closing to real-time operation solution such as DSO tendering for a flexibility service. In order to predict how much generation could assist during the peak consumption, an assessment of firm capacity is important. A mechanisms incentivising DG to generate or the consumption to stop consuming when the peak on the network takes place would enable more efficient use of the existing

distribution assets and deferral of grid reinforcement (Halberg, Alba Rios, et al. 2013). An extra service should be given for certain provision in the system. An open commercial tendering process by DSO can determine remuneration for that extra service for example DGs can bid certain amount of capacity reliably available through a local auction for certain service. DG or other commercial operator is considered reliable thus will be contracted to deliver certain firm capacity which must be financially responsible for its delivery. A one-size fits all approach may not be sufficient from the social welfare point of view because of the various technologies mixes of DGs, voltages levels of DGs and also geographic distribution of the resources.

The option of giving network customers a choice between firm injection and higher connection charges and non-firm injection and considerably lower connection charges should be assessed against other solutions. (Halberg, Alba Rios, et al. 2013).

a.3) Recommendation for DSO System Operation and Management

Incentives should be given to any DGs that sell their production into the electricity market. Aggregation of DG in form of so-called Virtual Power Plants (VPPs) or of DG, flexible loads and possibly decentralised storage is expected to play an important role in facilitating access of small customers to the market and addressing the uncertainty of availability and providing enhanced capability to manage the risk of not being able to meet the contracted scheduled output ((Halberg, Alba Rios, et al. 2013)). Electricity Service Companies (ESCO) or suppliers are also able to replace the role of the aggregator. It is also the responsibility of DG like other generators, in order to meet scheduling, nomination, balancing obligation, paying the balancing charges, take responsibility for their imbalance on equal term with other Balancing Responsible Parties. There should be incentive for variable RES technologies for reducing forecast error and minimizing imbalances in the market and taking up obligatory

responsibilities towards the system in order to keep the system stability and cost reduction, just like other generation technologies do.

Electricity market gets the serve and support from the network that works well. Problems in the physical, operational, or policy constraints could bring operational barrier to DG. Even though they are temporary and happen in particular time, there is possibility to detect them before or during the day-ahead, the hour-ahead market or during real time system operation. Those problems in the network could be eliminated and overcome by facilitating secure network operation and smooth functioning of the future market with increasing DER penetration. Therefore, the network needs an advance role of DSO, by becoming active operators and adequate tools must be provided to DSO.

a.3.1) Recommendation Traffic Lights Approach for DSO Operation

New system service in order to enable DSOs become more active should be offer to the new system and keeping the security, integrity and quality of supply in the DSOs' networks. There should be a clear definition about the voltage and reactive power contribution and ancillary services among the parties involved in the distribution network. In the figure below it show a detailed overview of such system service and the possibility form of delivery. It is recommended that in the future DSOs should be offered flexibility which usually through aggregators in order to be able to relieve congestion in their networks. This recommendation will not change the basic technical responsibility of TSO in order to provide balancing and re-dispatching in transmission grid, especially in the real-time flexibility.

Technical Cooperation of Transmission System and Distribution Generation

The operation of generation units in subordinate distribution network can make unbalance system

condition occurred in transmission systems. While generation/load balance is carried out at system level by the TSO, voltage control of the distribution grid requires the involvement of the DSO (Eurelectric (Halberg, Alba Rios, et al. 2013)). Distribution network need a changes because as the increasing of amount of DGs being connected to the network, it is no longer possible to make sure of a sustained system security without some dynamic resources, including reactive power compensation and active voltage control. This situation can be a threat a secure operation including disturbances in the system load and supply balance. A secure network operation has to be fulfilled by TSO in network operation during a threat to the system security. There are two levels of measure that are needed: network-related measures and market-related measures.

- a) Network-related measure at the first level has goal to eliminate threats through switching process in the transmission system
- b) Thus if a threat is not eliminated during the first level market-related measures at the second level it will be done. Several measures in the market-related measures are the use of operating reserve, load shedding, and the reduction of active power generation (dispatch curtailment) (Corfee, et al. 2011). As a consequence of this situation, DG dispatch and DSO network operation can be directly influenced by the TSO

The next figure illustrates the stages in the electricity market in which the network operators do not interfere, but act as the facilitator of the electricity system. Administration by network operators for both transmission and distribution system needs are shown by the green area. Such system service could be defined in grid codes (voltage and reactive power contribution) or procured as ancillary services from DG within a transparent and non-discriminatory regulatory framework (Eurelectric (Halberg, Alba Rios, et al. 2013)). Even though today, ancillary services are managed by the TSO (largely from large centralized power producers) in order to manage the system as whole. In the future, DSO should have the authority to relieve congestion from their networks in flexibility platforms where flexibility is offered in particular for close to real time flexibility.

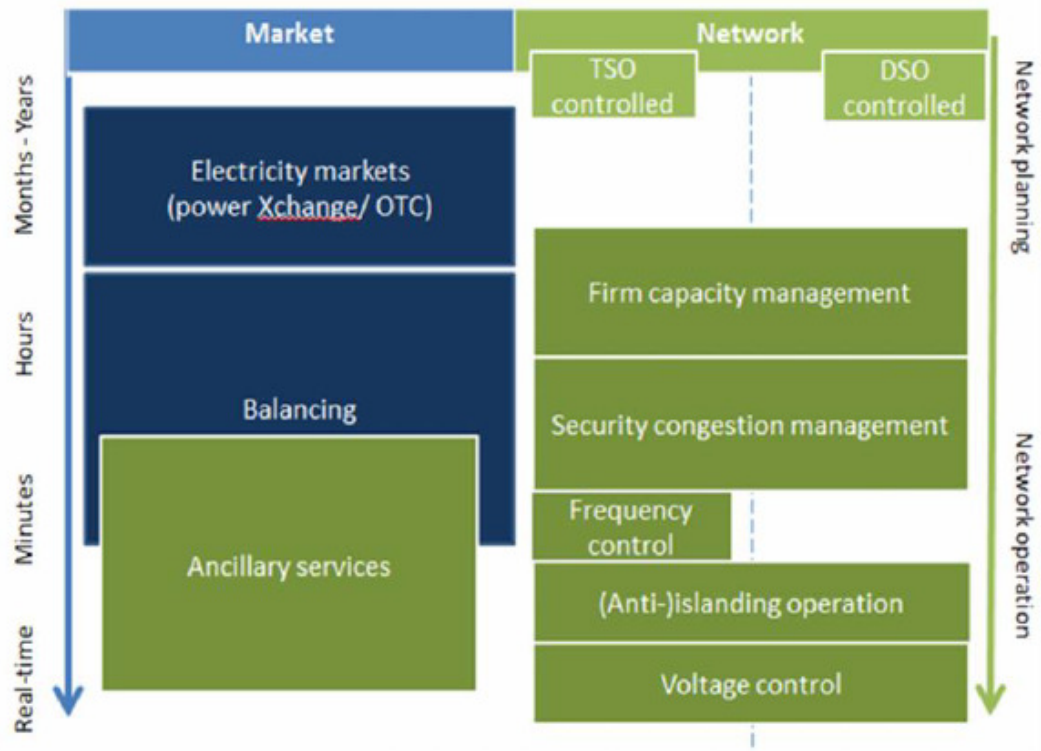

Figure 39: Market and Network Operations

Source :Eurelectric (Halberg, Alba Rios, et al. 2013)

Active DSO should be allowed in order to coordinate the offering of new system services, while ensuring the security integrity and quality of supply in their networks. Because the data that enable the active DSO, must be accumulated at substation level and in-depth knowledge of the grid, therefore DSO is best place to facilitate this mechanisms of system services. In EU member States, the DSO has a legal responsibility in order to make sure those technical constraints could be prevented.

DSOs need to have visibility the condition in electricity market side which probably has impact in the DSOs' network and influence network constraints in either the short or long term. One of the examples is when a flexibility provider has to use distribution system because its resources are connected to deliver its electricity

as the cause of its contract which provides reserves to the TSO. Distribution system could have bottleneck while this service needs to be transferred which will prevent the process of delivery. Therefore further investigation regarding technical aspects of flexibility is required.

An action needs to be done in the situation like congestion or voltage rise which will harm the system security, for example general curtailment. The DSO can ask the TSO, who is able to control active power of DG above a certain installed capacity, to constrain DG if there is a local problem (Halberg, Alba Rios, et al. 2013). It is recommended that DSOs has the authority only to react to DG actions, and furthermore TSO cannot monitor either the voltage or flows of distribution network condition. Eventually, this circumstance will degenerate the sustainability in the distributed system which take negative effect in both demand side and DG.

Meanwhile in certain modification cases needed either by DSO or TSO will not affect each other's ability in order to keep their network stability, which could be substantial in other cases. For example when the HV network or UHV have already been saturated, the MV network cannot be planned without taking into account the condition of High Voltage Level (HV) network. Minimizing losses in the electrical system can be done by an optimal network development by TSOs and DSOs by exchanging information regarding transmission and distribution network regularly

In order to support the quality of service and security of supply in distribution networks, ancillary services should be provided by DG, loads and decentralised storage. Moreover in order to solve grid constraints, it is better to have DSOs being able to buy flexibility

from DG and consumers. This situation can be less expensive than doing grid expansion, or also as alternative choice in order to wait until grid investments and reinforcements are finalised.

This recommendation will need flexibility in terms of new market mechanisms. With flexibility platforms, the parties involved in DG connection are able to have important role especially during real-time flexibility. Using mutually agreed conditions, this platforms would enable aggregators procure options to market customers' flexibility. A large number of DG and consumers would be grouped by aggregators in order to propose flexibility services to DSOs in terms of management of local constraints just like the flexibility services of TSOs in terms of balancing management of transmission network congestion.

In the liberalized market, transmission networks have basic system state defined in their operational. Therefore, in the distribution networks to enable the management of DGs, basic system states need to be defined too. Appropriate actions based on different system state can be chosen using a **“traffic light scheme”**.

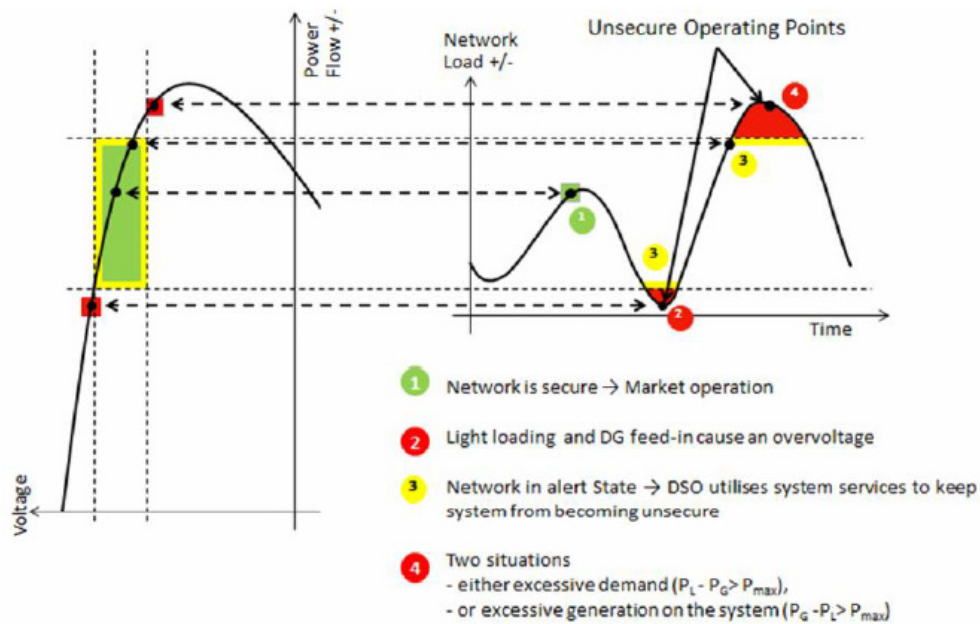

Figure 40 Traffic Light Scheme

Source: Eurelectric (Halberg, Alba Rios, et al. 2013)

Recommended being active in order to make sure the quality of power and service, DSOs have to manage the operation of distribution system, in which quite alike to the general practice in the transmission network by TSO. Basic system state should be define for example standardization in security and power quality and moreover standardization in terms of light scheme in order to distinguish system states.

a) DSO needs to make signal if the network condition operating state is normal, for example the condition is green. Green light describe the normal condition, when DSOs are able to operate using market –based procedures, in which there are no restrictions for grid users

b) When distributor operator has an emerging congestion, it means alert state, the DSO has to

make signal yellow. DSO actively engages with market (DG or load) to procure flexibility to relieve grid constraints(Eurelectric(Halberg, Alba Rios, et al. 2013)). Yellow light is alert/insecure states. In this situation, market-based procedures would be used by DSO in order to incentivise grid user to adjust production and/or consumption to the grid circumstance.

b.1) Via flexibility platform: in order to link the offers of aggregators with identification for the location, a methodology has to be developed. For examples, aggregators could divide their Virtual Power Network capacity into local pools. Moreover, a contract can be made by a DSO as an aggregator in order to deliver local generated or load from local capacity pool which can be facilitated by data hub.

b.2) Directly: in terms of making sure the maximization of the distribution asset utilization In planning and operational timescales, a DSO could contract the customer ,with transparency and non-discrimination way for example via tenders

c) Red light would warn that there emergency condition in the network which make DSOs necessarily carry through direct load management of emergency DG curtailment after the contracted options have been exhausted. And ex post action

should also be defined in order to describe justification and compensation of all actions taken under alert and emergency conditions. In the emergency cases, the DSO can give red signal. In strictly defined emergency cases, the DSO would be able to manage distributed renewable generation, to implement grid efficiency improvement measures, and to control the isolation and restoration of outages (Eurelectric (Halberg, Alba Rios, et al. 2013)). This last condition can be taken by DSO if only the rest of the option has failed to restore system integrity

a.3.2) Recommendation of Information Exchange between DSO and TSO

A well-structured and organised information exchange in the distribution networks are needed in the increasing share of DG and distribution grid flexible loads connection. In order to operate in real time and close to real time, DSOs need knowledge of DG forecasts, schedules, and planned maintenance. Recently, that useful information is often not received by DSOs. On the other hand, in some case, the TSOs could receive the information from DG while surpass DSO utterly.

A definition of a framework should be determined in order to exchange operational information between network operators, and between network operators and end customers for keeping the interest of safeguarding system security. It should be DSOs who accommodate TSOs with the operational information from final customers connected to distribution networks. When TSOs need the

information regarding safeguarding the operation of the system requires action from the customers, TSOs should not be able to bypass DSOs, TSOs should transmits these order to be routed via the DSO in question.

Additionally, more information will need by network operator in terms of organizing aggregators and independent power producers connected to their networks. Exchanging which information that should be exchanged between TSO and DSO in terms of overcome the constraints that happen in the distribution grid because of balancing market or constraints in transmission grids as the effects of DSO's decision in solving distribution network problem.

a.3.3) Recommendation for Voltage Control in Distribution Network

One of the system service should be done by DSOs is maintaining voltage in certain limits which is managed by DSOs in their distribution grid in order to minimises reactive power flows and eventually investments and technical losses in the system. Local solutions should be done in the distribution network that has increasing DG penetration because voltage problems would become more frequent. These local solutions will solve the problem of reactive power which cannot be transported over long distances and market procedures in certain cases cannot resolve this problem. DSOs are the ones that know better about the distribution network; therefore they are the one who should be permitted in order to investigate all local options with a goal in determining the most efficient one. Combination of network users (e.g generators that can produce or absorb reactive power) and the network itself

(e.g power electronics, controllable MV/LV transformers) are able to be the combination solution for DSOs. DGs necessarily have an responsibility to deliver a certain amount of reactive power which defined in connection and operation grid codes during user participation choice is the most cost-effective solution.

Active Power Balance and Frequency Stability

Maintaining the active power balance of the system and the related frequency stability require quantitative measurement of the system status (Corfee, et al. 2011). The system balance can be valued in real time projected for the future, if the current measurement and forecast values of supply and demand are almost precise. Potential network congestion can be predicted from this information. The active power balance can be controlled by the use of operating reserve from conventional power plants as well as the active power reduction generating units. (Corfee, et al. 2011)

Balancing system

Balancing system is a new system services that could be negotiated in market/ bilateral or be mandatory in grid way (Eurelectric (Halberg, Claxton, et al. n.d.)).As the number of DG grows more and more in the electricity system, national and local balances between supply and demand face more complicated problem in order to manage with high levels of variable generation, which can increase

total financial electricity costs. Both locally and globally region have to integrate variable generation and distributed energy resources by integrating them into the electricity network and into the energy market. Most networks impose balancing obligation on generators that use them in essences, this required a generator to predict its load patterns (Khoe, What Are the Regulatory Challenges Facing Distributed Generation? n.d.). That is why meeting the amount of supply as correct as possible is really important for a generator.

On the contrary in the situation of DGs, they do not have to meet this obligation as tight as centralized obligation because of their passive role in the electricity system. However, as the amount of integration of DGs in the electricity is growing , DGs are suppose to oblige to meet scheduling, nomination and balancing obligations as other power generators do, including payment of responsible parties. It is highly benefit for system stability and cost reduction if variable RES technologies are intensive to reduce forecast errors and to minimise imbalance in the market and take up necessary responsibilities toward the system as other generation technologies do (Eurelectric(Halberg, Alba Rios, y otros 2013))

Reactive Power Balance, Static Voltage Stability and Protection

Energy supply system is also affected by the steady-state voltage stability and the reactive power balance on the grid. On long transmission routes that are heavily loaded, the impedance increase that occurs through the failure of any of the parallel transmission system elements can lead to critical grid voltage conditions (Corfee, et al. 2011). In order to dispatch steady-state voltage stability can be assessed and reactive power reserves by using measurement technology in order to prevent critical voltage conditions. DG units can be sued for such network support if they are capable of supplying reactive power into the network (Corfee, et al. 2011). Guidelines that mention set-point values regarding voltage o reactive power which are transmitted via remote control system to DG on the MV and LV networks, must be determined by TSO and also DSO who knows better his distribution network.

Protection systems are required to ensure that DG systems are not supplying the network during outage conditions and can be resynchronised to the grid when power is restored (Fraser and Morita 2002).

Dynamic Grid Support

Dynamic grid support refers to stable behaviour of a generation plain in case of voltage depressions caused by grid faults (that is, fault ride-through capability) (Corfee, et al. 2011). Disconnection of

DGs in MV and LV networks that occurs abruptly, during a normal without any faults on the network should be avoided. Special technical steps that DG must be taken into account for their guidelines are:

- a) DG units should not disconnect from the grid during faults.
- b) Reactive powers for grid voltage stability have to be supplied by DG units during faults.

The performance criteria should be met during all faults types (that is, three phase faults and line to ground faults) In addition, the operation of the DG unit must continue for as specified fault duration. (Corfee, et al. 2011)

In order to prevent critical overloads in the network or other unacceptable grid condition, DG units must be able to reduce their output. TSO is the one who in charge of the assessments of critical system conditions. Determination of the set points for DG active power dispatch reductions are also made by the TSO and are issued to DGs via remote control (telecommunication) (Corfee, et al. 2011).By this active power ability, DSO should have authority regarding the curtailment of DG' proper production. A county that has liberalized its electricity market should make guidelines in order to differentiate the TSO authority and the DSO authority country.

a.3.4) Recommendation incentive for DSOs

Network operators especially DSOs have lack of incentives in order to consider heat in terms of distributed cogeneration. Operators will favour project having a positive impact on the system stability regardless of the increased efficiency to be achieved through production of electricity and heat (Martin 2009). Unfortunately, cogeneration is one of key assets of DG. Reinforcement work has to be undertaken to accommodate. This additional distribution costs (incremental Capital Expenditure and Operational Cost) caused by DG is seldom accounted for the current compensation of network operators (Martin 2009). This situation will make DG less favourable for distribution network operators.

a) Unbundling activities

DG integration to the electricity system will be supported by the independence of distribution network operator with respect to the centralized generation. Legal independence of those two parties should be done as the consequence of the electricity deregulation. When the ownership structures are the same entity the problem is even more critical. Studies even report unfair discrimination towards DG (Martin 2009). As DGs are frequently in a critical phase of their investment process when encountering such difficulties, this situation becomes a major problem. Moreover, DGs have relative small size proportion in the electricity system, unjustified delays and procedures might significantly affect their financial strength. There are several other regulatory recommendations, in its review of DG additional regulatory burdens in the form of:

1) Licensing requirements

Originally, licensing requirements were planned for large centralized generators, and the requirements are frequently irrelevant

for small scale generators or come at a high costs.

2) Solution in Pproblems in exported electricity

Ability to supply the grid when it is required or when consumption at the nearest point is too low is the benefit promised by DG. However the lack of visibility on the tariffs or the low tariffs for the electricity fed back to grid has been a major consideration or DG which affect the DG in terms of economic profitability of its project.

3) DSO consider DG as a competitor

As the result of unbundling between DSO and retail market, DSO that also operates DG may associate third party DG as competition and prevent the third party's access to the distribution network. Alternatively, a DSO that entirely unbundled from the retail function might consider DG which supplies to local areas as threatening its supply margin. (Khoe, What Are the Regulatory Challenges Facing Distributed Generation? n.d.)

VI. Conclusion

Since the liberalization of electricity system, in Europe, United States and South America, the electricity has change rapidly. The most efficient ways are being invented as time goes by in order to serve the electricity to the end user. More and more innovation is being introduced not only technology-wise but also policy-wise in order to fulfil security of supply of electricity, energy efficiency, and hopefully reduce the environmental pollution. Smart Grid is one of the innovation concepts and paradigm with all the benefits that gave promise to the society. It supports the need of electricity system in order to enhance the power quality and power services to the customer.

DG is part of innovation that was encouraged because of the need in the market itself due to the increasing of power usage from the demand side. DG promotes a lot of benefits too to the society in order to guarantee security of supply, energy efficiency and good environmental impact. Both concept smart grid and distribution generation support each other for delivering better power in quality and service to which is the basic need of a human being.

New technology always come not only with the benefit but also with all the drawbacks that could be predicted before or occur as the technology enter the market. It is common condition that the drawbacks, challenges and barriers are not about the technical side of the technology itself but also the social side of it. Being reluctant to innovation is not the solution to face the drawback. Finding out the solutions to the drawback is the best way in order to take advantage of the benefits that the innovation promotes. Either the solution will be from technical side or from social side will bring opportunity cost to figure out. As long as the cost and the solution gained can overcome the economic side of drawbacks of the new technology, thus the innovation can be carried on to the next level.

In the future, there will be other innovation as an impact of the penetration of DG and implementation of Smart Grid. The innovation could be technically physical form or social policy form in order to never stop finding ways to give better power to the society.

- 1) Differential impact of an increasing level of DGs on the effect to DSO cost should be recognized to existing regulation; therefore regulators must do investigation in order to propose alternative regulation that can properly consider the impact of increasing DGs.
- 2) Regulator should make formula regarding calculation of the impact connection DG on both OPEX and CAPEX are included
- 3) New calculation of incentive should be given to DSOs for stimulating them in terms of facilitating and accommodating new DG connection in their distribution networks.
- 4) If the provision of ancillary services assigned to DSOs as the impact of increasing presence of DG, then DG must compensate the DG operators for the benefit they get.
- 5) System services at distribution level should be implemented in the regulatory framework because it has role as a tool in order to support the local distribution grid for the stability and security of supply. Clear definition regarding system service such as voltage and reactive power contribution. Moreover ancillary services in the DSO territory within a transparent and non-discriminatory regulatory framework.
- 6) For those countries who have had implemented Smart Grid process in their networks. The Smart Grid should be used in order to support the new technical and method improvement in the distribution network which eventually will also accommodate the connection of DG in the network.
- 7) New market should be developed in terms of new players that involved in the buying and selling electricity as the consequence of the growth of DG. For example the possibility of aggregators to take part as intermediary to many small DG and load customers by offering the flexibility options to buy from their clients to TSOs and DSOs. The new market model will

actualize the energy and ancillary services, from demand, DG, and storage resources in the distribution network.

- 8) A new essential ICT system should be developed in order to support DSOs to do their new roles to be more active in the distribution network as they are going to apply the system services. The ICT system will also need to guarantee the security in the distribution network because of the increasing role of DSOs which need more interchange information with other players. This new ICT system will support DSOs in order to plan and manage the new opportunities and risk related to the grid, facilitate them and the other player such as generators, suppliers and consumers with network services. By having the new ICT system, DSOs are able to manage operation data in their network and support them to exchange information with TSOs in the suitable form.
- 9) In order to avoid grid congestion, existing rules regarding access regimes should be reviewed in order to arrange the new priority and guarantee in connection to grid as the increasing of DGs in the distribution network. Grid and market operators should be supported by these new rules in order to implement cost-effective solution and making efficient investment in grid extension.
- 10) As the DSOs have more active role in the electrical system, they should promote the economical solution in the transformation of the distribution network as the result of connection DGs. Any cost that should be replaced from CAPEX or OPEX must be taken into consideration by DSOs as long as enable the more efficient condition of network design and operation. Arrangement of remuneration for DSO should be made in the regulation either of the suitable reward for CAPEX or OPEX enhancement evolution.

Bibliography

Altmann, M, et al. "European Parliament/ Committee." January 2012. <http://www.europarl.europa.eu/activities/committees/studies.do?language=EN> (accessed December 2013).

Anaya, Karim L, and Michael G Pollitt. *Finding the Optimal Approach for Allocating and Realising Distribution System Capacity : Deciding between Interruptible Connections and Firm DG Connections*. Working paper, Cambridge: Cambridge, 2013.

Cali, Umit, Stephanie Ropenus, and Sascha Schroder. "Development of Interactions between Distributed Generation and Distribution System Operators West Denmark, Germany, the Netherlands, Spain, and the United Kingdom." *Intelligent Energy Europe*, 2009.

Collete Lewiner. "European Energy Markets Observatory." 2012.

Conchado, Adela, and Pedro Linares. "Gestion Activa de La Demanda Electrica Domestica : Beneficios y Costes."

Corfee, Karin, et al. "European Renewable Distributed Generation Infrastructure Study-Lessons Learned from Electricity Markets in Germany and SPain." *Kemak Consultant Report*, 2011.

Fraser, Peter, and Shin Morita. *Distributed Generation in Liberalised Electricity Markets*. Paris: International Energy Agency, 2002.

Giordano, Vincenzo, et al. "Smart Grid Projects in Europe : Lesson Learned and Current Developments." *JRC Reference Reports*, 2011.

Gischler, Christiaan, and Nils Janson. *Perspectives for Distributed Generation with Renewable Energy in Latin America and the Caribbean*. Santo Domingo: Compete Caribbean, 2011.

Government, Scottish. *The Scottish Government- Energy Storage and Management Study*. October 2010. <http://www.scotland.gov.uk/Publications/2010/10/28091356/4> (accessed June 2013).

Halberg, Per, Alan Claxton, Philippe De Raedemaeker, Andres Holm Foosnaes, Jesus Garcia Martin, and David Treballe. "Eurelectric Views on Demand-Side Participation : Involving Customers, Improving Markets, Enhancing Network Operation." *Eurelectric*.

Halberg, Per, et al. "Active Distribution System Management A Key Tool for the Smooth Integration of Distributed Generation." *Eurelectric*, 2013.

Hewitt, Judith, and Chris Lock. *www.ofgem.gov.uk*. February 2013. <https://www.ofgem.gov.uk/ofgem-publications/64006/householdenergybillsexplainedudjuly2013web.pdf> (accessed November 2013).

Jones, Willie D. *IEEE Spectrum*. 17 January 2012. <http://spectrum.ieee.org/riskfactor/energy/the-smarter-grid/parliament-predicted-benefits-of-uk-smart-metering-program-overblown> (accessed June 2013).

Karkkainen, Seppo. *Integration of Demand Side Management, Distributed Generation, Renewable Energy Sources and Energy Storages*. Task, Finland: International Energy Agency Demand-Side Management Programme.

Khoe, Richard. "What Are the Regulatory Challenges Facing Distributed Generation."

Khoe, Richard. "What Are the Regulatory Challenges Facing Distributed Generation?"

Krulla, Katrina, et al. *Assessment of the Distributed Generation Market Potential for Solid Oxide Fuel Cells*. National Energy Technology Laboratory Report, U.S. Department of Energy, 2013.

Leth Bak, Claus, et al. *Department of Energy Technology*. <http://www.et.aau.dk/research-programmes/smart-grids-active-networks/> (accessed June 2013).

Lighter, Eric M. "Smart Grid and DER Integration Activities Supported by the U.S Department of Energy." *3rd International conference on integration of renewable and distributed energy resources*. Nice, 2008. 4.

Martin, Jeremi. "Distributed vs. Centralized Electricity Generation :Are We Witnessing A Change of Paradigm ." 2009.

McCrone, Angus, et al. *Global Trends in Renewable Energy Investment 2012*. Frankfurt: Frankfurt School Unep Collaborating Centre for Climate & Sustainable Energy Finance, 2012.

Migaud, et al. *The Cost of The Nuclear Power Sector*. Paris: Cour des Comptes, 2012.

Mohn, Terry, Jesse Berst, and Larisa Dobriansky. *Santa Fe Innovation Park*. 2013. <http://santafeinnovate.org/projects/smart-systems-center-microgrid-lab/> (accessed November 2013).

N.N. *Cogeneration & On-site Power Production*. 1 January 2010. <http://www.cospp.com/articles/print/volume-11/issue-1/features/utility-engagement.html> (accessed June 2013).

N.N. "Empowering Consumers and Promoting Innovation through Smart Grid." *Commiteed on Science, Space and Technology Subcommittee on Technology and Innovation U.S House of Representatives*.

—. "Environmental Leader." *Environmental & Energy Management News*. August 2012. <http://www.environmentalleader.com/2012/08/14/pike-distributed-renewable-power-supply-to-triple-by-2017/?graph=full&id=1> (accessed 2013).

—. "Euelectric Power Statistics & Facts." *Eurelectric*. December 2013. http://www.eurelectric.org/media/113667/power_statistics_and_trends_2013-2013-2710-0001-01-e.pdf (accessed January 2014).

—. *European Commission Resarch and Innovation*. 2013. http://ec.europa.eu/research/energy/print.cfm?file=/comm/research/energy/nn/nn_rt/nn_rt_dg/article_1160_en.htm (accessed June 2013).

—. *GE digital energy.com*. 2012. http://www.gedigitalenergy.com/IndSolutions/ind_distAutomation.htm (accessed June 2013).

—. *National Fuel Cell Research Center/ University of California, Irvine*. June 2013. http://www.nfcr.uci.edu/2/FUEL_CELL_INFORMATION/FCexplained/stationary.a.spx (accessed June 2013).

—. *Nucleo de Excelencia em Geracao Termelétrica e Distribuida Excellence Group in Termal Power and Distributed GGeneration*. June 2013. http://www.nest.unifei.edu.br/english/pags/laboratories/labgerdis/labgerdis_en.html (accessed June 2013).

N.N. *Reliable Electricity Based on Electrochemical Systems (REBELS)*. Advanced REsearch Projects Agency-Energy, U.S Department of Energy, 2013.

N.N. *SEL-547 Distributed Generator Interconnection Relay Utility-Grade Protection for Distribution Generation*. Washington, 2002.

—. *Solar Energy in Bolivia*. 4 May 2009. <http://solarenergyinbolivia.wordpress.com/2009/05/04/pv-system-grid-connected/> (accessed June 2013).

—. *Tribal Energy and Environmental Information Clearing*. 2013. <http://teeic.anl.gov/er/wind/restech/scale/index.cfm> (accessed June 2013).

—. *U.S Energy Information Administration*. 1 November 2012. <http://www.eia.gov/todayinenergy/detail.cfm?id=8590> (accessed June 2013).

—. *Whole Building Design Guide*. June 2013. <http://www.wbdg.org/resources/microturbines.php> (accessed June 2013).

—. *www.energy.siemens.com*. 2013. <http://www.energy.siemens.com/hq/en/fossil-power-generation/gas-turbines/sgt5-8000h.htm> (accessed June 2013).

—. "www.esource.com." *Busines Energy Advisor*. 2011. <http://www.esource.com/escrc/0013000000DP22YAAT/BEA1> (accessed June 2013).

Nagaraj, Varun, and Ravi Pragasam. *Desi Smart Grid*. 24 July 2012. <http://www.desismartgrid.com/2012/07/smnuplc/> (accessed June 2013).

Nowaczyk, Joepsh, and Bryan Cox. "Planning fo the Future: Teh Smart grid." *Westenr Energy*, 2012.

Paul, Jean-Philippe. "2011 Reliability Report." *Reseau de transport d'electricite*, 2011.

Perez-Arriaga, Ignacio, et al. *From Distribution Network to Smart Distribution Systems : Rethinking the Regulation of European Electricity DSOs*. European University Institute, 2013.

Perlman, Brett. *Houston's Energy Future*. 2009. <http://www.houstonenergyfuture.com/energy-collaborative/smart-grid-task-force/> (accessed June 2013).

Pipattanasomporn, Manisa, Patrick Ryan, Saifur Rahman, and Erich Gunther. *Smart Grid Information Clearinghouse*. September 2009. <http://www.sgiclearinghouse.org/ConceptualModel> (accessed June 2013).

Price, Snuller, et al. *Cost-Effectiveness of Distributed Generation Technologies*. California: Itron, Inc, 2011.

Prins, David. *Department of Environment and Primary Industries*. 20 February 2012. <http://www.dpi.vic.gov.au/smart-meters/resources/reports-and-consultations/flexible-pricing-of-electricity> (accessed June 2013).

Quezada, Víctor H. Méndez, Juan Rivier Abbad, and Tomás Gómez San Román. *Assessment of Energy Distribution Losses for Increasing Penetration of Distributed Generation*. Madrid: IEEE, 2006.

Robb, John. *Resilient Communities*. 8 November 2012. <http://www.resilientcommunities.com/an-island-of-resilience-in-a-sea-of-chaos/> (accessed June 2013).

RODRIGUES DA COSTA, Manuel, et al. "European Commission's Communication on "Smart Grids : from innovation to deployment"." *Eurelectric*, 2011.

Rogers, Jenny. *Scottish and Southern Energy*. 4 January 2013. <http://www.ssepd.co.uk/HaveYourSay/Innovation/Portfolio/ADR/> (accessed June 2013).

Schoenung, and Hasselzahn. *ClimateTech Wiki*. 2003. <http://climatetechwiki.org/technology/jiqweb-ee> (accessed Junw 2013).

Secretariat, OECD. *Policy Rountables : Electricity Renewables and Smart Grids*. OECD, 2010.

Shum, Kwok L. "Renewable Energy Technology- Is It a Manufactured Technology or an Information Technology." *Sustanaibility*, 2010: 3.

Singh, Sid. *Envirosynthesis Ventyx : Virtual Power Plants*. 28 April 2010. <http://envirosynthesis.blogspot.com.es/2010/05/ventyx-virtual-power-plants.html> (accessed June 2013).

Skytte, Klaus, and Stephanie Ropenus. "Assessment and Recommendations Overcoming in Short-Term Grid Sytem Regulatory and other Barriers to Distributed Generation." 2005.

Somesmo. "European Comission Eurostat." *Eurostat*. March 2013. http://epp.eurostat.ec.europa.eu/statistics_explained/index.php/File:Cumulative

_market_share_and_installed_capacity_share,_2011_(%25).png (accessed January 2014).

Sommerville, Paul, Viive Sawler, and Francesca Vantaggiato. *International Case Studies on Technical and Economic Considerations*. International Confederation of Energy Regulators, 2012.

Trebolle, David. *The New Role of DSO*. Madrid, 2011.

Van Sambeek, E.J.W, and M.J.J Scheepers. "REGulation of Distributed Generation." *Policy and Regulatory Roadmaps for the Integration of Distributed Generation and the Development of Sustainable Electricity Networks*, 2004.

Wildiers, Zoe, et al. *Wind Energy The Facts*. <http://www.wind-energy-the-facts.org/en/scenarios-and-targets/> (accessed June 2013).

Young, Alasdair, and Wolfson College. *How Information and Communication Technologies Will Change Electrical Networks Into Smart Grid*. Cambridge: University of Cambridge, 2012.

Annex 1 The Benefit of DG

The Benefit of DG

DG development of DGS promise benefits to the society which are:

a) **Supporting the Liberalisation of Electricity Markets**

In the liberalisation market, customer should have more choices regarding the resources of electricity that they used. DG is associated as a tool that can fill in niches in the liberalised market. DG technology can use different technologies that capable to offer the electricity suppliers in order to supply the type of electricity they prefer. The electricity players are allowed in the electricity sector to respond in more flexible way to changing market conditions compare to situation when there was only centralized generation. Moreover DG has smaller sizes compare to centralized generation which make it more flexible and needs less time to be constructed.

b) **Taking part as standby capacity or peak use capacity**

Regarding the price fluctuations especially during peak times, DG can serve as a hedge against this situation. In the US, the major use of DG is for facing the price fluctuations.

c) **Network related benefit**

Depending the of technology being used by the DG, reduction in network losses is the network related benefit due the usage of the DG in the network. Regarding the DG technologies, it should be noted that wind power is the one that shows the worst behaviour in losses reduction.

(Quezada, Abbad and San Román 2006). The network losses could have because electricity has to travel far away from the centralized generation to transmission, distribution, until the end consumer received it. DG could overcome this issue by locating DG closer to load so less wastage of power in transit. Furthermore DG is able to minimize congestion and brings through the adjournment to either the transmission or distribution network, as well as assisting with voltage report.

Unfortunately, there are certain conditions that are needed to be fulfilled in order to make sure that DG will not cause network losses because the capability of DG to supply reactive power depends on its generator technology. Reactive power can be controlled only by some DG technologies such as traditional wind farms based on asynchronous generators. Some other DG technologies for instance CHP plants with synchronous generators are able to control reactive power. Until certain number the small amounts of DG, losses in the network can start to decrease. Once the minimum level is reached, if DG penetration level still increases, then losses begin to marginally increase too. (Quezada, Abbad and San Román 2006). Losses in the network can be higher compare to the situation when the network without DG connected if DG penetration level increases enough.

d) Giving energy alternative resources

In terms of meeting demand, DG offers more flexible way especially given the freedom the liberalised market. In the past, large centralised generators would be built to respond to demand and, being 'lumpier' investment, would offer result in over capacity (a risky thing in a liberalised market). (Khoe, What Are the Regulatory Challenges Facing Distributed Generation? t.thn.) Additionally, the use of DG improves the overall alternative of energy of an electricity system especially the easier of building of DG in terms of the size and value of investment. DG will be less vulnerable to any external disturbances to security of supply because its

locations are closer to loads than centralized generation. Furthermore, at time of transmission has line failed, the electricity system may even rely on DG in order to supply power to a local area.

Due to its smaller size, investment in DG can be associated less risky in a competitive environment like centralized generation.

Initial investment in existing plants

Overnight cost breakdown	€ 2010
Construction costs	€72 862 million
Engineering and labour costs	€6 888 million
Pre-operating charges	€3 488 million
Total	€83 238 million

Figure 41 :Initial investment in Nuclear existing plants in France

Source :(Migaud, et al. 2012)

SMALL DISTRIBUTED CAPACITY INVESTMENT, 2004-2011, \$BN

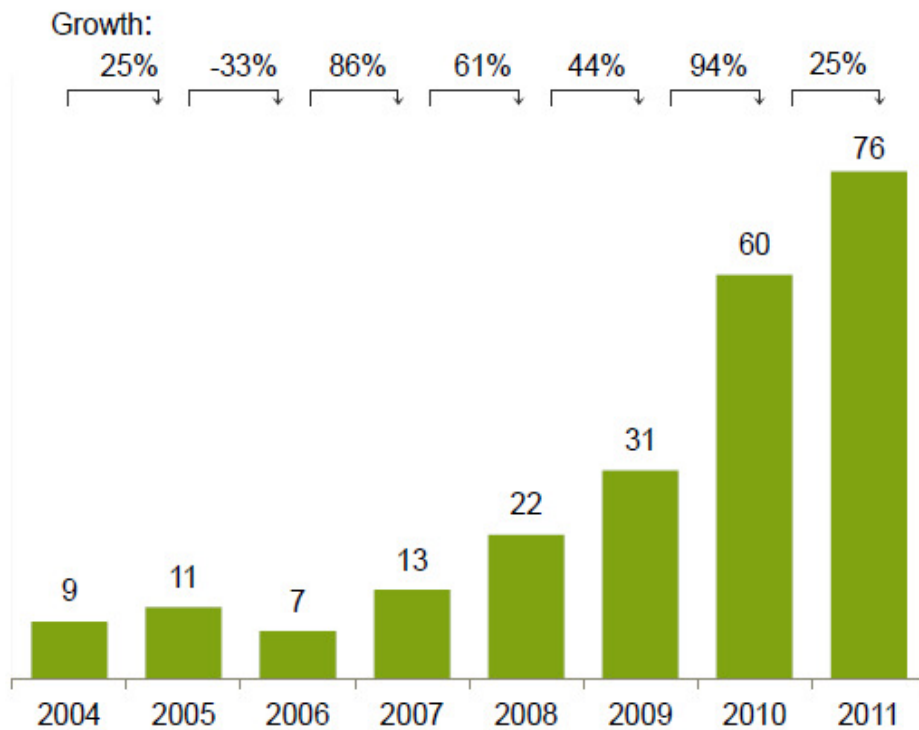

Represents investments in solar PV projects with capacities below 1MW.
 Source: Bloomberg New Energy Finance

Figure 42Initial investment in Small Distributed Capacity Investment

Source : (McCrone, et al. 2012)

In terms of small scale of DG, there are project of less than 1 MW capacity which have become increasingly important in the renewable energy sector recently because the cost of solar panels has come down. Figure 6 shows that small-scale project spending worldwide has climbed rapidly from just \$ 9 billion in 2004, via \$ 22 billion in 2008, to a record \$ 76 billion in 2011. (McCrone, et al. 2012)

Figure 7 shows the details for three different types of investment in the US in the year. As we can see, solar dominated the asset finance at \$ 25.3 billion. Wind contributed a mere \$ 11.3 billion to US asset finance in 2011,

down from \$ 15.4 billion in 2010 and well below the record \$18.1 billion achieved in 2008.

VC/PE, PUBLIC MARKETS, AND ASSET FINANCE INVESTMENT IN RENEWABLE ENERGY IN THE US BY SECTOR, 2011, \$BN				
Units: \$bn	Asset finance*	Public markets	VC/PE	Total
Solar	25.3	0.6	1.71	27.6
Wind	11.3	0.0	0.2	11.5
Biofuels	1.8	0.6	0.67	3.1
Biomass & w-t-e	1.2	-	0.2	1.4
Geothermal	0.5	0.10	0.11	0.6
Small hydro	0.1	-	0.01	0.1
Marine	-	-	0.002	0.002

Figure 43 Public Markets and Asset Finance Investment in Renewable Energy in the US by sector

Source :(McCrone, et al. 2012)

The energy alternatives offered by DG should also promise variability in electricity prices that comes with liberalised markets, since consumers forced to pay prices closer to the full cost of electricity at peak periods will have an incentive to install their own generators (Kloe, What Are the Regulatory Challenges Facing Distributed Generation? t.thn.)

DGs have variety of technology used to generate power. The most common types of generator that comprise DG today are reciprocating engines (including diesel engines), gas turbines, fuel cells, photovoltaic, wind turbines, micro-turbines and co-generation (also known as combined heat and power, or CHP). (Kloe, What Are the Regulatory Challenges Facing Distributed Generation? n.d.) The next sub chapter will be discussed about the types of technology in DG.

