



Master's in industrial engineering + Master's in  
Business Management and Administration

**Analysis of Non-Fungible Tokens (NFTs) from an  
Industrial Property perspective.**

**Iratxe Astigarraga Pablogorran**

Director: Dr. Antonio García Garmendia

Collaborating Entity: ICAI – Universidad Pontificia Comillas.

July, 2023



Declaro, bajo mi responsabilidad, que el Proyecto presentado con el título Analysis of Non-Fungible Tokens (NFTs) from an Industrial Property perspective. en la ETS de Ingeniería - ICAI de la Universidad Pontificia Comillas en el curso académico 2022-2023 es de mi autoría, original e inédito y no ha sido presentado con anterioridad a otros efectos. El Proyecto no es plagio de otro, ni total ni parcialmente y la información que ha sido tomada de otros documentos está debidamente referenciada.



Fdo.: Iratxe Astigarraga Pablogorran

Fecha: 26/07/2023

Autorizada la entrega del proyecto

EL DIRECTOR DEL PROYECTO

Fdo.: Antonio García Garmendia

Fecha: 26/07/2023

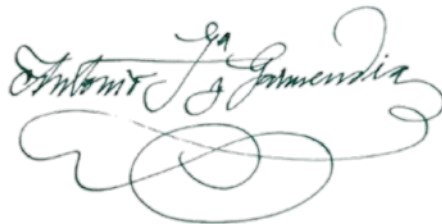





Master's in industrial engineering + Master's in  
Business Management and Administration

**Analysis of Non-Fungible Tokens (NFTs) from an  
Industrial Property perspective.**

**Iratxe Astigarraga Pablogorran**

Director: Dr. Antonio García Garmendia

Collaborating Entity: ICAI – Universidad Pontificia Comillas.

July, 2023



# ANÁLISIS DE LOS TESTIGOS NO FUNGIBLES (NFTS) DESDE UNA PERSPECTIVA DE PROPIEDAD INDUSTRIAL

**Autor: Astigarraga Pablogorran, Iratxe**

Director: Dr. Antonio García Garmendia

Entidad colaboradora: ICAI – Universidad Pontificia de Comillas.

## RESUMEN DEL PROYECTO

### Introducción

Los NFT son activos digitales únicos caracterizados por su escasez, rareza y autenticidad. Además, representan derechos transferibles de objetos del mundo real, proporcionan un registro verificable de propiedad y permiten obtener ingresos por regalías de las transacciones de NFT. Este activo digital ha experimentado un notable crecimiento desde 2020, emergiendo como una aplicación significativa en la tecnología financiera o *Fintech*. De hecho, el año 2021 fue testigo de una "explosión del mercado" con inversiones masivas en NFT, y las proyecciones esperan un crecimiento de más de 147 mil millones de dólares para 2026.

Sin embargo, el campo de la propiedad industrial está especialmente interesado en las NFT debido a los retos asociados a la obtención de patentes, marcas o registros de derechos de autor, que son procesos largos, costosos y administrativamente complejos. Además, el actual sistema internacional de patentes se basa en oficinas de patentes independientes y no existe un mercado centralizado o un repositorio actualizado a nivel mundial, lo que dificulta aún más la trazabilidad de los derechos de propiedad industrial. Por estas razones, la tecnología NFT ofrece una solución para acelerar y mejorar estos procesos, proporcionando protección y titularidad seguras para la propiedad industrial, al tiempo que facilita el comercio y la comercialización de estos activos, además de aportar liquidez al mercado.

Debido al creciente interés por este tipo de activos y a la escasez de estudios al respecto, este trabajo aborda el vacío existente en este campo investigando el potencial de la transmisión de derechos de propiedad industrial como NFTs. En primer lugar, se establece un marco teórico, seguido del diseño de un marco que incorpora el Blockchain al actual sistema de patentes. Además, se ofrece una propuesta de contrato inteligente que

necesitaría una oficina de patentes para gestionar las patentes como NFTs. Por último, se realiza un análisis económico para determinar el impacto económico que supondría la implantación del marco propuesto en las oficinas de patentes.

### **Revisión de literatura**

Los tokens no fungibles (NFT), desempeñan un papel central en la red Blockchain, introduciendo activos criptográficos únicos que los diferencian entre sí. Estos activos se crean a través de un proceso conocido como acuñación, y normalmente necesita de los contratos inteligentes, que son códigos autoejecutables que residen en la Blockchain, para establecer las normas de propiedad y regir la transferibilidad del NFT. Estos contratos inteligentes desempeñan un papel fundamental a la hora de garantizar la aplicación automática de los derechos y condiciones asociados al NFT, evitar acciones no autorizadas y proporcionar un marco sólido para transacciones seguras.

El contrato inteligente estándar más común para los NFT es el ERC-721, que establece las normas fundamentales de funcionamiento, incluyendo el saldo del usuario, las direcciones de propiedad, la circulación de tokens y las transferencias. Sin embargo, ERC-721 puede ampliarse con funciones adicionales a través de módulos, lo que permite a los usuarios añadir funciones adicionales a sus colecciones de NFT implementándolas en sus contratos inteligentes. Esto mismo es lo que se ha hecho en el marco desarrollado para permitir que el contrato inteligente dado sea capaz de gestionar patentes como NFTs.

Por otro lado, las patentes, comúnmente conocidas como patentes de invención, son el método predominante para salvaguardar las innovaciones técnicas. Cuando una patente es concedida por un estado o una oficina regional que representa a varios estados, el titular de la patente obtiene el derecho exclusivo de impedir que otros exploten comercialmente la invención durante un periodo determinado, normalmente 20 años. El titular de una patente tiene la opción de conceder licencias a otras personas o entidades en condiciones mutuamente acordadas, a cambio del pago de regalías. Además, el titular de la patente puede optar por vender los derechos sobre la invención, transfiriendo la titularidad de la patente a una nueva parte.



Sin embargo, cuando se habla de patentes como NFT, al comprar una NFT los compradores adquieren principalmente derechos de propiedad sobre la propia NFT, no sobre los derechos de PI asociados. Esto significa que no adquieren automáticamente los derechos sobre el contenido digital subyacente. Sin embargo, los compradores pueden tener la capacidad de mostrar, ceder o vender la copia a través de una licencia, condiciones de venta, leyes pertinentes o contratos inteligentes, especificando los derechos de la propiedad industrial, permisos de uso y cualquier tasa de reventa o regalía asociada a la NFT. La aplicabilidad de estos términos puede variar en función de las leyes vigentes y, dado que el marco jurídico de las NFT aún está evolucionando, pueden surgir complejidades en las transacciones transfronterizas y problemas jurisdiccionales.

### **Propuesta de un marco híbrido para la gestión de patentes como NFT**

A la luz de la actual ausencia de un marco regulador para la gestión de patentes como NFT y el hecho de que un sistema integral de gestión de patentes basado totalmente en la Blockchain es todavía un trabajo en curso, se propone una solución pragmática a corto plazo. Este marco construido sobre un contrato inteligente tiende un puente entre los sistemas de patentes tradicionales y la posible implementación futura de un ecosistema de patentes respaldado totalmente por la red Blockchain.

El marco propuesto para gestionar las patentes como NFT incluye cuatro capas. La primera capa engloba el procedimiento tradicional de solicitud y examen de patentes, garantizando la calidad y validez de estas. Una vez se emite una patente, pasaríamos a la segunda capa que incluye un Smart Contract especializado por parte de la Oficina Española de Patentes y Marcas (OEPM) para emitir NFTs que representen patentes y facilitar las transacciones con ellas. La tercera capa sirve como interfaz de usuario para interactuar con la Blockchain, permitiendo el acceso público a las NFTs de patentes y sus metadatos, y la cuarta capa prevé un mercado global para el comercio de patentes como NFTs, fomentando la colaboración entre las oficinas de patentes de todo el mundo y aprovechando el potencial de Blockchain para un sistema de patentes seguro, trazable y escalable (ver Fig. 1).

Fig. 1. Arquitectura del marco propuesto

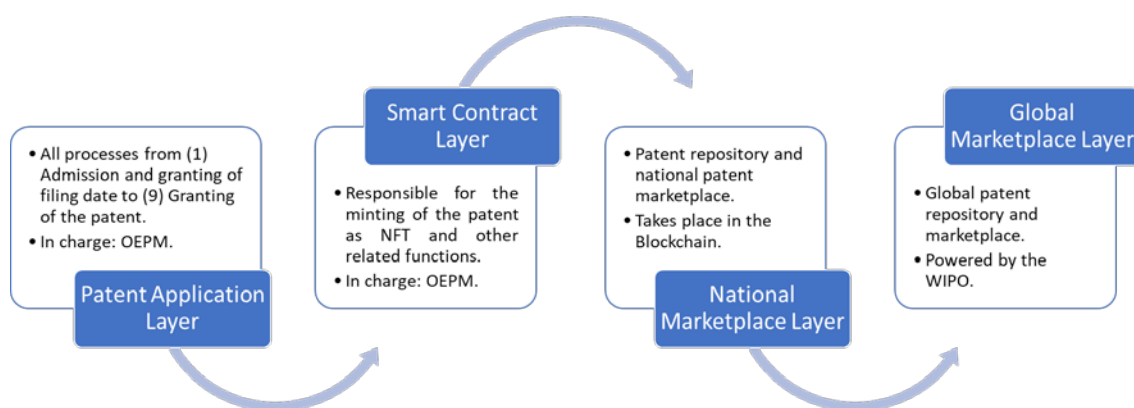

Fuente: elaboración propia

Como se ha explicado, el marco propuesto está basado en un contrato inteligente. Este, una vez creado, se inicializa con detalles esenciales, como el nombre del contrato, el símbolo, el URI base para los metadatos del token, las tasas de registro iniciales y las entidades autorizadas para interactuar con él. Una vez establecidas, las entidades autorizadas pueden emitir patentes y proporcionar la información necesaria, como el título de la patente, la dirección del inventor y el periodo activo. El pago de las tasas de registro se verifica antes de que se emita la patente, y se asigna un ID de token único al NFT recién acuñado que representa la patente. Además, los usuarios pueden pagar tasas de registro y los propietarios de las patentes pueden fijar las regalías y los precios de venta de sus patentes. Las compras de patentes se facilitan tras comprobar que el propietario y el precio son correctos, y entonces la propiedad se transfiere al comprador. A continuación, el contrato inteligente distribuye los fondos a las partes correspondientes, incluidos los derechos de autor al inventor.

### **Análisis económico**

El análisis económico realizado en este capítulo tuvo como objetivo evaluar el potencial impacto económico de implementar el sistema de patentes híbrido propuesto, que combina la tecnología Blockchain con el marco de patentes tradicional existente. El análisis económico en este estudio se dividió en dos partes fundamentales, cada una arrojando luz sobre diferentes aspectos de la introducción de la tecnología Blockchain en las transacciones de licencias de patentes.

En la primera parte, se llevó a cabo un análisis exhaustivo de varios escenarios, acompañado de una proyección de beneficios a cinco años. Esta exploración en profundidad permitió una comprensión más profunda de los posibles beneficios a largo plazo e implicaciones financieras para los titulares de patentes en el contexto de la gestión de patentes impulsada por Blockchain. Al final, el Escenario 3 demostró el mayor impacto económico, con una reducción de costos de 2.4 millones de euros. En este escenario, se integra la tecnología Blockchain en el sistema de patentes, lo que lleva a la reducción de la fuerza laboral en once personas de 498, asumiendo un salario anual promedio de 44,654 € Además, se utiliza el almacenamiento descentralizado, lo que resulta en ahorros de costos para la organización.

En la segunda parte, se realizó una meticulosa evaluación para medir el impacto potencial de la implementación de la tecnología Blockchain en el precio de las licencias de patentes. Los cálculos revelaron que el precio podría experimentar un aumento significativo, con estimaciones que alcanzan hasta 32.36 millones de euros. Además, al eliminar la participación de terceros, se podría lograr una reducción adicional de costos de 0.5 millones de euros.

## **Conclusión**

Esta tesis profundiza en el potencial de los tokens no fungibles (NFT) en la gestión de la propiedad industrial y explora la incorporación de la tecnología Blockchain al sistema de patentes. Mediante una metodología exhaustiva, la investigación examina los aspectos jurídicos, tecnológicos y económicos de las patentes como NFT.

Los resultados destacan la promesa de las NFT y Blockchain para demostrar la titularidad, permitir transacciones seguras y mejorar la liquidez en el ecosistema de patentes. Sin embargo, la falta de normativas establecidas plantea dificultades para su aplicación práctica, lo que impulsa el desarrollo de un marco híbrido que equilibre las ventajas de Blockchain con el sistema de patentes existente. La arquitectura propuesta ofrece una transición sin fisuras, fomentando la eficiencia y la fiabilidad en la gestión de patentes al tiempo que establece un sistema mundial de patentes descentralizado e interconectado.

A pesar de los beneficios potenciales, se reconocen limitaciones como la naturaleza incipiente de la tecnología Blockchain y la exclusión de determinadas variables en el análisis económico. Para impulsar futuros avances, se recomienda la colaboración entre el mundo académico, las oficinas de patentes y los responsables políticos para establecer un marco jurídico y perfeccionar el marco desarrollado. En general, esta investigación contribuye al creciente conocimiento de las NFT y la tecnología Blockchain, ofreciendo posibilidades transformadoras para la gestión de la propiedad industrial y el ecosistema de patentes.

# ANALYSIS OF NON-FUNGIBLE TOKEN (NFTSs) FROM AN INDUSTRIAL PROPERTY PERSPECTIVE

**Author: Astigarraga Pablogorran, Iratxe**

Director: Dr. Antonio García Garmendia

Collaborating Entity: ICAI – Universidad Pontificia de Comillas.

## **ABSTRACT**

### **Introduction**

NFTs are unique digital assets characterized by scarcity, rarity, and authenticity. They represent transferable rights of real-world objects, provide a verifiable record of ownership, and enable royalty earnings from NFT transactions. They have seen remarkable growth since 2020, emerging as a significant application in financial technology or *Fintech*. In fact, the year 2021 witnessed a "market explosion" with massive investments in NFTs, and projections expect a growth of over \$147 billion by 2026.

However, the field of industrial property is particularly interested in NFTs due to the challenges associated with obtaining patents, trademark, or copyright registrations, which are time-consuming, costly, and administratively complex processes. Moreover, the current international patent system relies on separate patent offices, which creates inefficiencies, and there is a lack of a centralized marketplace or updated repository, making traceability of industrial property rights even more difficult. For these reasons, NFT technology offers a solution to accelerate and enhance these processes, providing secure protection and ownership for industrial property, while facilitating the trade and commercialization of these assets, as well as providing liquidity to the market.

Due to the growing interest in this type of asset and scarcity of studies in this regard, this work addresses the existing gap in the field by investigating the potential of transmitting industrial property rights as NFTs. First, a theoretical framework is established, followed by the design of a framework that incorporates the blockchain into the current patent system. In addition, a proposal for a smart contract a patent office would need to manage patents as NFTs is provided. Finally, an economic analysis is conducted to determine the economic impact of leveraging the proposed framework on patent offices.

## **Literature review**

Non-Fungible Tokens (NFTs), play a central role in the blockchain network, introducing unique cryptographic assets that differentiate them from one another. These assets are created through a process known as minting, and typically leverages smart contracts, which are self-executing codes residing on the blockchain, to establish ownership rules and govern the transferability of the NFT. These smart contracts play a pivotal role in ensuring that the rights and conditions associated with the NFT are automatically enforced, preventing unauthorized actions, and providing a robust framework for secure transactions.

The most common standard smart contract for NFTs is ERC-721, which sets the fundamental rules for NFTs, including user balances, ownership addresses, token circulation, and transfers. However, ERC-721 can be extended with additional functionality through modules, allowing users to add extra features to their NFT collections by implementing them in their smart contracts. This same thing is what it has been done in the developed framework to enable the given smart contract to be able to manage patents as NFTs.

On the other hand, patents, commonly known as patents for inventions, are the predominant method of safeguarding technical innovations. When a patent is granted by a state or a regional office representing multiple states, the patent owner gains the exclusive right to prevent others from commercially exploiting the invention for a specified duration, typically 20 years. The owner of a patent has the option to license to other individuals or entities under mutually agreed conditions, in return for “royalty” payments. Furthermore, the patent owner can choose to sell the rights to the invention, transferring ownership of the patent to a new party.

However, when talking about patents as NFTs, purchasing an NFT, buyers primarily acquire ownership rights to the NFT itself, not the associated IP rights. This means that they do not automatically gain the rights to the underlying digital content. Nevertheless, buyers may have the ability to display, assign, or sell the copy through a license, sales terms, relevant laws, or smart contracts, specifying the IP rights, usage permissions, and any resale or royalty fees associated with the NFT. The enforceability of these terms may vary depending on applicable laws, and as the legal framework for NFTs is still evolving, complexities in cross-border transactions and jurisdictional issues may arise.

## Proposal of a hybrid framework for managing patents as NFTs

In light of the current absence of a regulatory framework for managing patents as NFTs and the fact that a comprehensive system of managing patents entirely on the blockchain is still a work in progress, a pragmatic short-term solution is proposed. This framework built on top of a smart contract bridging the gap between traditional patent systems and the potential future implementation of a fully blockchain-based patent ecosystem.

The proposed framework for managing patents as NFTs includes four layers. The first layer retains the traditional approach for patent application and examination, ensuring the quality and validity of patents. The second layer involves the creation of a specialized Smart Contract by the Spanish Patent and Trademark Office (OEPM) to issue NFTs representing patents and facilitate transactions with them. The third layer serves as a user-interface to interact with the blockchain, allowing public access to patent NFTs and their metadata, and the fourth layer envisions a global marketplace for trading patents as NFTs, fostering collaboration among patent offices worldwide and leveraging blockchain's potential for a secure, traceable, and scalable patent system (see Fig. 1).

Fig. 2. Proposed framework architecture

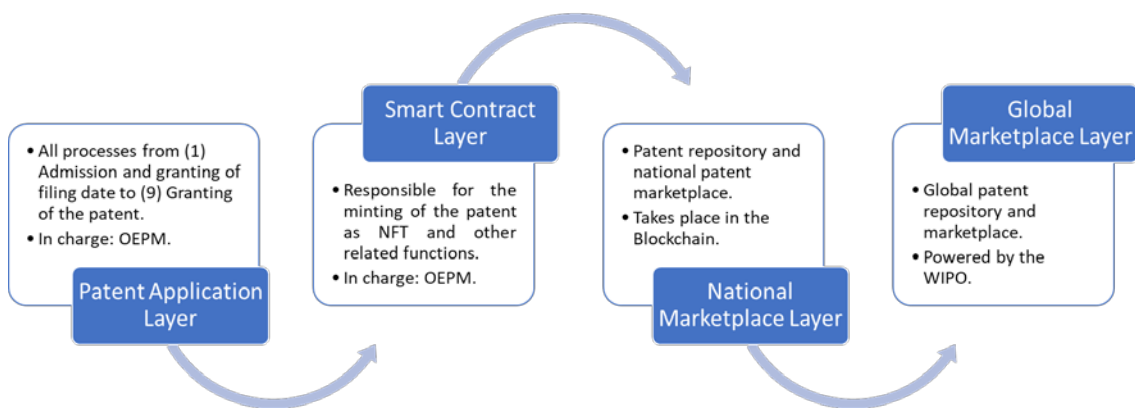

Source: own elaboration

Like explained, the framework is built up on a smart contract that is initialized with essential details, including the contract name, symbol, base URI for token metadata, initial registration fees, and authorized entities. Once set up, authorized entities can issue patents and providing necessary information such as the patent's title, inventor's address, and active period. Payment of registration fees is verified before the patent is issued, and a unique token ID is assigned to the newly minted NFT representing the patent.

In addition, users can pay registration fees and patent owners can set royalties and sale prices for their patents. Patent purchases are facilitated after checking the owner and the price are correct, and then ownership is transferred to the buyer. The smart contract then distributes funds to the appropriate parties, including royalties to the inventor.

### **Economic analysis**

The economic analysis performed in this chapter aimed at assessing the potential economic impact of implementing the proposed hybrid patent system, which combines blockchain technology with the existing traditional patent framework. The economic analysis in this study was structured into two pivotal parts, each shedding light on different aspects of introducing blockchain technology in patent licensing deals.

In the first part, a comprehensive analysis of various scenarios was undertaken, accompanied by a five-year profit projection. This in-depth exploration allowed for a deeper understanding of the potential long-term benefits and financial implications for patent holders in the context of blockchain-powered patent management. In the end, Scenario 3 demonstrates the largest economic impact, amounting to 2.4-million-euro cost reduction. In this scenario, the blockchain is integrated into the patent system, leading to the reduction of the workforce by eleven people out of 498, assuming an average annual salary of 44,654€ Additionally, decentralized storage is utilized, resulting in cost savings for the organization.

In the second part, a meticulous assessment was conducted to gauge the potential impact of blockchain implementation on the deal price of patent licenses. The calculations revealed that the price could experience a significant increase, with estimates reaching up to 32.36 million euros. Additionally, by eliminating the involvement of third parties, an additional cost reduction of 0.5 million euros could be achieved.

### **Conclusion**

This thesis delves into the potential of Non-Fungible Tokens (NFTs) in industrial property management and explores the incorporation of blockchain technology into the patent system. Through a comprehensive methodology, the research examines the legal, technological, and economic aspects of patents as NFTs.



Findings highlight the promise of NFTs and blockchain in proving ownership, enabling secure transactions, and enhancing liquidity in the patent ecosystem. However, the lack of established regulations poses challenges for practical implementation, prompting the development of a hybrid framework that balances the benefits of blockchain with the existing patent system. The proposed architecture offers a seamless transition, fostering efficiency and reliability in patent management while establishing a decentralized and interconnected global patent system.

Despite the potential benefits, limitations such as the nascent nature of blockchain technology and exclusion of certain variables in the economic analysis are acknowledged. To drive future advancements, collaboration between academia, patent offices, and policymakers is recommended to establish a legal framework and refine the developed framework. Overall, this research contributes to the growing understanding of NFTs and blockchain technology, offering transformative possibilities for industrial property management and the patent ecosystem.



## Table of contents

1. Introduction .....	5
1.1 Framing of the topic .....	6
1.2 Objectives and scope of the study .....	8
1.3 Methodology .....	9
1.4 Thesis structure .....	11
2. Literature review .....	13
2.1 Overview of crypto markets: Fungible vs. Non-Fungible tokens .....	14
2.2 Non-Fungible Tokens .....	19
2.2.1 Infrastructure behind NFTs .....	19
2.2.2 NFT blockchain platforms and standards .....	21
2.3 Understanding Industrial Property: Patents .....	25
2.3.1 Overview of industrial property .....	25
2.3.2 The Patent system in Spain .....	27
3. Specific literature review: Patents as NFTs .....	33
3.1 Legal considerations for managing patents as NFTs .....	34
3.2 Decentralized conceptual framework for managing patents as NFTs .....	35
4. Proposal of a hybrid framework for managing patents as NFTs .....	45
4.1 Proposed framework architecture .....	46
4.2 Smart contract for managing patents as NFTs .....	50
4.2.1 ERC-721 Smart Contract .....	50
4.2.2 Additional functionalities for managing patents .....	53
5. Economic Analysis. A practical case study .....	65
5.1 Patent office perspective .....	66
5.1.1 Base scenario: traditional patent system .....	66
5.1.2 Scenario 1: revenue optimization scenario in a centralized storage system	

5.1.3	Scenario 2: labor cost reduction in a centralized storage system .....	72
5.1.4	Scenario 3: labor cost reduction in a decentralized storage system .....	73
5.1.5	Summary and comparison of the four scenarios .....	74
5.2	Patent licensor perspective.....	76
6.5.1	Patent license pricing in the Biopharma industry .....	78
6.	Conclusion.....	83
6.1	Discussion .....	84
6.2	Work conclusions .....	87
7.	Bibliography.....	91
8.	Annex I: Glossary.....	101
9.	Annex I: Code .....	107
9.1	PatenteNFT.sol .....	107
9.2	Owner.sol.....	115
9.3	ERC721Enumerable.sol.....	116
9.4	Strings.sol .....	120
10.	Annex II. Complying with SDG principles.....	123
10.1	SDG Dimensions .....	123
10.2	Why is Ethereum becoming more efficient? PoW vs. PoS .....	125

## List of Figures

Figure 1. Web1 vs Web2 vs Web3 .....	14
Figure 2. The Blockchain process .....	15
Figure 3. Bitcoin vs. Dollar exchange rate historical data.....	17
Figure 4. Ethereum vs. Dollar historical data.....	18
Figure 5. How to mint an NFT .....	20
Figure 6. Functions of Public and Private Keys .....	21
Figure 7. Fungible, Non-Fungible and Semi-Fungible tokens .....	22
Figure 8. Architecture of the decentralized conceptual framework .....	36
Figure 9. Decentralized authentication.....	40
Figure 10. Verification Layer sequence diagram .....	42
Figure 11. Proposed framework architecture .....	47
Figure 12. Global Patent System .....	49
Figure 13. Random NFT details .....	51
Figure 14. Decentralized storage in Ethereum .....	52
Figure 15. Functioning of smart contracts.....	53
Figure 16. Contract initialization.....	56
Figure 17. Sale of a patent.....	57
Figure 18. Patent issuance, registration, and management through a smart contract.....	63
Figure 19. Ethereum average gas price (3Y).....	71
Figure 20. Profit projection 2021-2027 .....	75
Figure 21. Licensing prices without and with the implementation of the blockchain....	82

## List of Tables

Table 1. Summary of the functionalities for managing patents.....	57
Table 2. Description of scenarios .....	66
Table 3. Issued and active patents per year .....	66
Table 4. OEPM Income distribution by titles.....	68
Table 5. Profit projection Base scenario.....	69
Table 6. Profit projection Scenario 1 .....	71
Table 7. Profit projection Scenario 2.....	72
Table 8. Profit projection Scenario 3.....	73
Table 9. NVP of profits in the different scenarios.....	75
Table 10. Patent licensing variable summary.....	80
Table 11. Patent licensing pricing variables without Blockchain .....	81
Table 12. Patent licensing pricing variables with Blockchain.....	81
Table 13. Glossary.....	101

## **1. Introduction**

This chapter serves as an essential introduction to the thesis, providing the necessary context for the research. The chapter is divided into four key sections that collectively establish the groundwork for the study on managing patents as Non-Fungible Tokens (NFTs). In Section 1.1, the topic is framed, presenting an overview of the subject and its significance. Section 1.2 focuses on outlining the specific objectives and scope of the study, defining the key areas of exploration. Moving on to Section 1.3, the chosen methodology is explained, detailing the approach employed to gather and analyze data. Finally, Section 1.4 highlights the structure of the thesis, guiding readers through the subsequent chapters and providing a clear roadmap of the research. Together, these sections lay a solid foundation for the study and contribute to a better understanding of the management of patents as NFTs.

## 1.1 Framing of the topic

Non-Fungible Tokens (NFTs, hereafter) are an emerging phenomenon that has experienced exponential growth since 2020 [15] becoming one of the most significant applications in the field of financial technology or Fintech. 2021 was the year of the "market explosion" of NFTs, with over 36 billion euros invested [111] and is expected to grow by over \$147 billion by 2026 [85], which demonstrates the international relevance of Non-Fungible Tokens. Some of the most popular examples of NFT transactions include the sale of a digital artwork for a whopping \$69 million by artist Beeple in 2021 [34] and Twitter ex-CEO Jack Dorsey's first tweet, which was auctioned for \$2.9 million that same year [15].

But what are exactly NFTs? NFTs are non-interchangeable digital assets characterized by their scarcity, rarity, exclusivity, and authenticity, that can represent digital versions and become transferable rights of real-world objects [6]. They are special certificates of authenticity that are connected to blockchains and are usually issued by the creators of the assets. Hence, a creator can easily demonstrate its existence and ownership, as well as earn royalties every time one of their assets is successfully traded on an NFT market or through peer-to-peer exchanges [127]. When an entity acquires an NFT, it effectively obtains a digital record associated with that token, which can subsequently be transferred to a digital wallet [64]. This is possible thanks to the blockchain technology behind non-fungible tokens, along with distributed ledger technology in general, which allow for securely assigning certificates of originality and ownership to NFTs [13].

However, although non-fungible tokens have many applications due to their characteristics, their usefulness in the field of industrial property is of special interest. This is because obtaining patents is a long, manual process that involves high costs and administrative difficulties [12]. Indeed, registering a trademark or obtaining a copyright on something can take months, while obtaining a patent can be a years-long process [12]. In addition, the international patent system is currently based on nationally and internationally operated registries called patent offices. The responsibility of these is to examine applications and determine whether they are eligible for patent protection. Once accepted, patent offices also have the duty to register and manage licenses, warranties, and changes of ownership in the registers [79]. These formalities sometimes require the transaction of legal documents and involve third party bodies, which leads to the process



of obtaining a patent becoming inefficient [99]. An additional problem with the current patent system is that regulatory offices are not interconnected worldwide. Although patent offices may collaborate and share information through bilateral or multilateral agreements, such as Patent Cooperation Treaty (PCT), enabling applicants to seek patent protection simultaneously in multiple countries [100], there is no marketplace or updated repository with records of industrial property rights, which makes traceability difficult [13].

Nevertheless, with the help of certain characteristics of the technology used by NFTs, it is possible to accelerate these processes, ensuring the protection and ownership of industrial property. In fact, it is believed that the tokenization of intellectual property (IP) will help patents be more easily sold, traded, commercialized, or otherwise monetized, as well as bring new liquidity to this asset class for investors and innovators. In addition, tokenization increases transparency while making related transactions simpler and more cost-effective [63]. For this reason, it is expected this new reality will make a difference in the global market of patents since, according to Forbes, of the 2.1 million active patents in the United States, 95% of them failed to be licensed or commercialized [39], and globally, only a small fraction, approximately 0.3 percent, of patents have been successfully brought to market [74]. Therefore, there is room for improvement.

On the other hand, although there are some start-ups and other companies that are promoting the sale and purchase of NFTs with platforms such as EOS, Algorand and Tezos, as well as alternative marketplaces such as SuperRare and Rarible, and OpenSea [13], currently none of them enable acquiring patents as NFTs. It is IPwe, together with IBM, who announced their partnership on April 20, 2021, to be the first to create a patent marketplace on the blockchain. By creating an infrastructure - an agreement among multiple patent holders to jointly license their Intellectual Property (IP) - and using IBM cloud and IBM blockchain, they enable representing patents as NFTs on their platform [63]. IPwe has also collaborated with CasperLabs to develop a chain of custody (CoC) Solution. This involves utilizing the Casper public blockchain to safeguard and track patent information, ensuring the authenticity of patent ownership. The IPwe Platform, hosted on the IBM Cloud and employing Blockchain services like the Casper Network, facilitates the storage and distribution of Patent NFTs and is expected to become commercially accessible in the near future [10].

Thanks to the possibility of representing patents as NFTs, organizations will be able to view the industrial property more easily as an asset on their balance sheet, and it will be beneficial for SMEs in particular, because it allows IP to be treated as collateral or assurance of an organization's value, also allowing it to be more easily leveraged when seeking funding [63]. In addition, they believe this will lead to the introduction of new financial products and services by financial institutions and companies, aiming to facilitate the development of a novel category of patent assets.

Due to the growing interest in this type of asset and scarcity of studies in this regard, this work aims to address the existing gap in the field by investigating the potential of transmitting industrial property rights as NFTs, along with the legal, technical, and economical implications. In addition, once a theoretical framework has been established, a software through which patents can be registered, consulted, bought, or sold will be developed on the Blockchain. This software, also called *protocol* or *smart contract*, will establish a framework for the technical specifications, interoperability, and functionalities of NFTs within a specific ecosystem governing the transmission of data from one computer to another [133]. Finally, an economic analysis will be conducted to determine the economic impact of leveraging the proposed framework on patent offices. The expected throughput will be analyzed alongside with the estimated cost reduction.

## **1.2 Objectives and scope of the study**

This master's thesis has the main objective of designing a framework which includes the development of a smart contract through which patents could be traded as NFTs. The idea is that the owner of the patent transmitted as an NFT is the sole owner of the "original" token, with this information recorded on the blockchain. The blockchain system facilitates its management and monetization, providing transparency, traceability, cost reduction, and new opportunities for the market.

However, a prior theoretical analysis is needed. The patent industry operates within a highly regulated framework, with strict laws and procedures governing the protection and enforcement of intellectual property rights. On the other hand, Non-Fungible Tokens (NFTs) operate on blockchain technology, which is based on decentralized networks.

This fundamental difference between the two systems raises the need to carefully study the legal, technical, and economic requirements associated with trading patents as NFTs.

Firstly, it is essential to examine the legal and regulatory frameworks surrounding patents to understand how they can be applied to this digital format and ensure compliance with existing laws. Additionally, studying the technical requirements and infrastructure needed to support the transfer, storage, and authentication of patent related NFTs is crucial. This includes exploring the scalability, security, and interoperability of blockchain networks for managing patent assets. Furthermore, it is necessary to examine the economic implications of introducing NFTs into the global patent system. This encompasses analyzing the potential impact on patent ownership, licensing models, and the overall value proposition for stakeholders involved in the patent ecosystem.

These objectives can be summarized in the following statements:

1. Analyze the potential of NFTs in industrial property management considering legal, technical, and economic implications.
2. Design a framework which includes the development of a smart contract based on the blockchain for managing patents as NFTs.
3. Examine the economic implications adopting the proposed NFT-based patent framework would have on the national and in international patent offices.

### **1.3 Methodology**

To address the objectives outlined in this final master's thesis, a three-phase approach was adopted. Firstly, a comprehensive literature review was conducted to examine the existing findings and identify key factors and criteria relevant to patents as Non-Fungible Tokens (NFTs). This process formed the basis of the theoretical and conceptual framework that supported the subsequent investigation. Academic databases such as Google Scholar were utilized to search for pertinent articles, employing a combination of keywords like “patents as NFTs,” “patents,” and “NFT ecosystem,” to ensure a broad coverage of the topic. As the research progressed, additional keywords such as “legal considerations,” “technical requirements,” “infrastructure,” and “economic implications” were incorporated to refine the search and explore more specific aspects of patents as NFTs. Additional non-scientific sources were also consulted occasionally.

Then, the development of the framework was initiated after conducting a comprehensive literature review. This review enabled the identification of flaws and points of failure in previous works, facilitating a clearer understanding of the research gap and the need for a new approach. Once an initial framework idea was conceptualized, further study was undertaken to assess its feasibility. This involved examining specialized papers, videos, and online courses dedicated to understanding the functioning of the blockchain. Additionally, to effectively implement the framework, it was necessary to acquire programming skills in Solidity, a programming language commonly used for smart contract development on the blockchain. To gain proficiency in Solidity, a combination of specialized papers, online resources, and courses were also utilized. The prior knowledge and expertise acquired in the field of electronics through the master's degree also proved advantageous in comprehending the technical aspects of the framework's implementation in addition to advice from experienced connection in the field. Moreover, to be able to test the smart contract an online compiler called Remix IDE was used, which is an integrated development environment designed specifically for working with smart contracts on the Ethereum blockchain, enabling developers to verify the behavior and functionality of their code before deploying it to the live blockchain.

Following the development of the framework, an economic analysis was conducted to evaluate the financial impact of transitioning to the proposed hybrid blockchain-based patent framework, both from the patent office and from a patent holder perspective. Specific patent databases, including the one from the Spanish Patent Office, were consulted to gather relevant data and insights, and this analysis involved the identification of several scenarios to calculate the differential increase in profits that could be achieved by adopting the new system. Drawing upon the foundational financial knowledge acquired during the MBA program, well-founded predictions were made to assess the potential outcomes. By quantifying the financial benefits and comparing them against the costs and risks associated with the implementation, this analysis served as a valuable tool to support the argument for leveraging blockchain technology in patent management.

Upon the completion of the main parts and throughout the entirety of this study, highest emphasis was placed on maintaining cohesion between different parts and implementing a step-by-step approach. By carefully structuring each section and employing a systematic approach, the research aims were effectively addressed, and the objectives were met with precision.

## **1.4 Thesis structure**

This academic work is divided into ten main parts which are the introduction, the literature review (a general and a more specific one), the development of the framework, the economic analysis, the conclusion, references, and three annexes, a glossary, one including the code of the developed smart contract, and the third one related to the SDG principles.

The introduction section begins by justifying the chosen topic, highlighting the importance of exploring the potential of patents as Non-Fungible Tokens (NFTs). It addresses the need for a decentralized approach within the patent industry and outlines the objectives of the research. The methodology employed to achieve these objectives is described, including the research approach, data collection methods, analysis techniques, and other relevant procedures. Additionally, the structure of the thesis is provided, offering an overview of the main sections and their order.

The Literature Review section provides an overview of the crypto markets, distinguishing between Fungible Tokens and Non-Fungible Tokens. It explores the unique characteristics and use cases of NFTs, specifically in relation to digital assets. The underlying infrastructure supporting NFTs is discussed, including the technical aspects of blockchain technology and its role in enabling the creation, ownership, and transfer of NFTs. Various blockchain protocols and platforms relevant to NFTs are also examined. Furthermore, the section explores patents as a regulated industry and examines the feasibility of representing patents as NFTs. It addresses the challenges, legal considerations, and economic implications associated with trading patents on the NFT ecosystem.

The next section focuses on the development of an application or software for managing patents as NFTs. After exploring and comparing the benefits of a centralized NFT-based patent framework with those of a decentralized approach, it outlines the technical requirements and infrastructure considerations necessary to facilitate the registration, consultation, buying, and selling of patents within a blockchain-based framework. In addition, the functionalities of the smart contract developed are also explained, as well as providing details of the code that will enable the creation, trading and management of patents as NFTs.

Following the development section, the economic implications of leveraging the proposed NFT-based patent framework are thoroughly analyzed. The first part of the analysis considers several scenarios to comprehensively evaluate the financial impact of the framework. Each scenario is meticulously examined, considering various factors such as labor costs, transaction fees, and revenue generation. To provide a robust and insightful evaluation, a five-year projection was performed for each scenario, allowing for an assessment of their long-term profitability and feasibility. In the second part of the economic analysis, an examination of how the price of a patent license could change was conducted, shedding light on the potential benefits that blockchain technology could bring to patent holders.

The conclusion is divided into a discussion and a conclusion part. While the discussion comments the potential benefits and challenges of managing patents as NFTs, the conclusion of the work summarizes the main findings of the research, highlighting the implications and potential benefits of using NFTs for patents. It acknowledges any limitations encountered during the study and suggests future areas of research and development.

The references section provides a comprehensive list of all the sources cited throughout the thesis, following the appropriate citation style guidelines, and finally, an annex section is included to incorporate a glossary, the code of the developed smart contract as well as to assess the compliance of patents as NFTs with the principles outlined in the United Nations' Sustainable Development Goals (SDGs). This assessment aims to evaluate how the adoption of NFTs for patents aligns with the principles of sustainability, innovation, inclusivity, and social impact as set forth by the SDGs. It provides an analysis of the potential positive and negative implications of implementing NFTs for patents from an SDG perspective.

## **2. Literature review**

This chapter serves as a comprehensive literature review, offering a critical examination of key aspects related to managing patents as Non-Fungible Tokens (NFTs). Divided into three distinct sections, the chapter provides valuable insights into the subject matter. Section 2.1 provides an overview of crypto markets, distinguishing between fungible and non-fungible tokens and exploring their unique characteristics. In Section 2.2, the infrastructure behind Non-Fungible Tokens is discussed, shedding light on the underlying technology and platforms that support their creation and transaction. Finally, Section 2.3, the focus shifts towards understanding industrial property, specifically patents, elucidating the fundamental concepts and legal frameworks governing patent protection. By examining these sections collectively, this literature review provides a comprehensive understanding of the intersection between patents and NFTs, thereby establishing a solid foundation for the subsequent chapters of the thesis.

## 2.1 Overview of crypto markets: Fungible vs. Non-Fungible tokens

The internet has undergone significant transformations since its inception. In the early days of the internet, often referred to as Web1, the focus was primarily on static websites that provided information for users to read. Web1, or the "read-only web," lacked interactive features and user-generated content. However, with the advent of Web2, the internet underwent a paradigm shift, leading in a new era of interactivity and participation. Web2, also known as the "read-write web" or the "social web," emerged in the early 2000s and introduced dynamic websites, social media platforms, and interactive web applications that allowed users to create, share, and collaborate. This transition from Web1 to Web2 brought about a fundamental change in how people engaged with the internet, empowering them to actively contribute and participate in the online ecosystem [19][94].

However, the internet is now progressing towards its next phase, commonly referred to as Web 3.0 or Web3 in the digital asset realm. Web3 represents a future vision where individuals can possess digital assets, engage in seamless online transactions, and exercise greater control over their personal data. This new paradigm offers the potential for ownership of digital assets and enables convenient and secure online transactions. Additionally, Web3 aims to empower individuals by giving them more sovereignty over their personal information, ensuring privacy and data control in the digital realm [2].

Figure 1. Web1 vs Web2 vs Web3



Source: Maurya (2023) [77]



In this global, connected and increasingly digitized environment, innovation and the development of new technologies are transforming sectors as we knew them, as is the case of the blockchain technology. The blockchain serves as a foundational technology for Web3, which represents the next generation of the internet, providing the underlying infrastructure that enables decentralization, transparency, and security, and allows value or tokens to be exchanged without intermediaries, also called *peer-to-peer* [13]. This is thanks to the fact that the blockchain consists of a single-record network in which all nodes (computers connected to the network) have a copy [56]. These nodes store information from the previous block and pass data to the next through cryptographic techniques, which makes it possible to create a distributed ledger in a computer network without the need for a central server. Modification of this ledger can only be carried out in consensus with all the nodes that are part of the network (see Figure 2) [1]. Therefore, the blockchain is an emerging technology that poses a threat to existing business models, since its application results in cost reduction and streamlining of the process, as well as offering greater transparency and traceability [82].

Figure 2. The Blockchain process

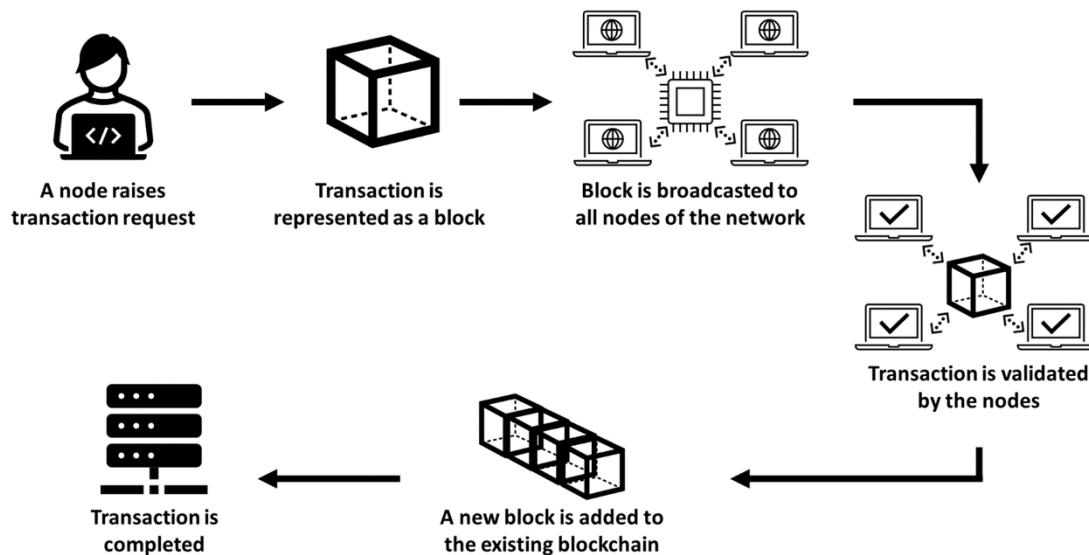

Source: Raja & Muthuswamy (2022) [105]

The explosive development of this technology in recent years is causing the tokenization of assets of all kinds to grow. These digital assets, have no value in themselves, but acquire the value of the good or service they represent [111], and are grouped into two main groups: fungible and non-fungible goods. Fungible Tokens, among which is the

Bitcoin cryptocurrency, are identical, divisible, exchangeable, and replicable tokens. A Non-Fungible Token, on the other hand, is a unique and irreplaceable digital asset used as a unit of value, which, through blockchain technology is assigned a certificate of originality [12]. This information is transmitted as metadata and recorded on the blockchain by decentralized storage systems [127].

While Fungible Token transactions are located on the network (on-chain), NFT transactions can be stored either on-chain or outside of the network (off-chain). If the information is stored on-chain, it means that the information describing that particular token is stored directly in the smart contract representing it. Smart contracts, as programmable applications that utilize the blockchain's programming language, they can manage not only traditional data but also assets that possess economic value. On the other hand, if the information is off chain, which is the latest update, the information is stored in external registries, resulting in a cost reduction due to space optimization and allowing multiple copies in several nodes [13].

The off-chain storage of data, in addition to avoiding bottlenecks in central servers, is currently the most widely used in NFTs due to Ethereum's storage limit and high maintenance costs. This is done through third-party services who simplify this process by allowing you to store your data on existing IPFS nodes, eliminating the need to run your own IPFS node [134]. In these cases, instead of including a copy of the file, a cryptographic "hash" is used as the identifier of the NFT. This hash is then associated with the token and recorded on the blockchain to reduce gas consumption [38].

This continuous improvement is possible because the blockchain is a highly scalable system built on constant updates [13]. Although the blockchain technology has its roots in the concept of a distributed ledger, which can be traced back to the early 1990s, the specific implementation of blockchain as we know it today emerged in 2008 with the introduction of Bitcoin as the first expression of virtual money. It was introduced by an anonymous individual or group using the pseudonym Satoshi Nakamoto [81]. Later, with Bitcoin technology as a base, Colored Coins were created, one of the attempts by the community of creators to expand the functionality of Bitcoin. Colored coins are considered the first step towards the creation of NFTs, as these marked coins have special properties that represent real physical assets. Later, in 2014, Ethereum was launched, which builds on Bitcoin's innovation but with important differences [12].

Among others, while both Bitcoin and Ethereum enable users to utilize digital currency without relying on payment providers or traditional banks, Ethereum distinguishes itself by offering programmability, allowing users to construct and launch decentralized applications (or DApps) on its network. This feature sets Ethereum apart from Bitcoin, providing additional capabilities beyond the simple transfer of digital funds, enabling developers to create innovative decentralized applications that go beyond basic financial transactions. Consequently, “while Bitcoin is only a payment network, Ethereum is more like a marketplace of financial services, games, social networks and other apps that respect your privacy and cannot censor you” [44]. In order to make transactions within the network, both platforms have their own native cryptocurrency, which are Bitcoin (BTC) in the case of Bitcoin and Ether (ETH) in the Ethereum platform. Like any other currency, their value varies through time and can be influenced by various factors such as market demand, adoption of Ethereum and Bitcoin technologies, and overall market conditions. According to the European central Bank [23], in November 2021, the value of Bitcoin reached its peak at USD 69,000, but subsequently experienced a decline, dropping to USD 17,000 by mid-June 2022 (see Figure 3).

*Figure 3. Bitcoin vs. Dollar exchange rate historical data*



Source: Google Finance (2023)

Regarding Ethereum, ETH saw a notable increase in its price due to exciting technological developments and the growing popularity of decentralized finance (DeFi). The implementation of the "Berlin" upgrade in April 2021 and the subsequent Ethereum merge in 2022, which reduced transaction fees, generated great enthusiasm among traders. However, by the end of 2022, the collapse of FTX and other factors led to a decrease in the value of Ether.

As of June 12, 2023, the value of one ETH was approximately \$1,751.72 USD, significantly less than the \$4,400 USD at the end of 2021 (see Figure 4) [119] [138].

*Figure 4. Ethereum vs. Dollar historical data*



Source: Google Finance (2023)

When it comes to trading volume, “while Bitcoin suffered a 31.4 per cent decline in trading volume compared to a year earlier, it remained the most traded crypto asset of 2022 with a trading volume of USD 3.36 trillion” [28]. According to data from DappRadar, in the case of NFTs, which account for 28% of transactions in Ethereum, the overall volume of NFT sales in the past year came close to matching the peak seen in 2021. Overall, “the NFT market generated around USD 24.7 billion worth of organic trading volume in 2022 across blockchain platforms and marketplaces” [57].

In addition to their shared technological infrastructure, NFT marketplaces such as OpenSea and Rarible further strengthen the connection between the cryptocurrency market and the NFT market by facilitating the utilization of cryptocurrencies, predominantly Ether (ETH), as a means of payment and trade [80]. Considering that users typically require cryptocurrency to acquire NFTs, it is reasonable to assume that fluctuations in the cryptocurrency market significantly impact the smaller NFT market. However, Aharon & Demir [4] demonstrated that NFTs are predominantly independent of shocks originating from other asset classes. This is because, while NFTs share a common foundation of blockchain technology and smart contracts with cryptocurrencies, they substantially differ from traditional digital currencies like Bitcoin or Ethereum in their nature and function. NFTs do not serve as a currency, commodity, or technology; rather, they operate as unique assets [133].

## 2.2 Non-Fungible Tokens

### 2.2.1 *Infrastructure behind NFTs*

Non-fungible tokens (NFTs) are cryptographic assets that exist on a blockchain. What sets NFTs apart is their unique identification codes, which differentiate them from one another, enabling seamless token transfers between owners and providing a reliable means to verify ownership [129].

NFTs are generated through a procedure known as minting, which involves recording the NFT's information on a blockchain, or basically publishing an NFT on the blockchain for purchase [85]. In simple terms, the minting process involves the creation of a new block, validation of the NFT information by a validator, and the closure of the block. This process often incorporates *smart contracts* (“digital contracts stored on a blockchain that are automatically executed when predetermined terms and conditions are met” [130]) that assign ownership and govern the transferability of the NFT. This is done by the Ethereum Virtual Machine (EVM), which is a piece of software that operates on the Ethereum blockchain and carries out the execution of smart contracts [53]. During the minting process, each token is assigned a distinct identifier that is directly linked to a specific blockchain address. Every token has an owner, and the ownership information, including the address where the minted token is stored, is publicly accessible [116]. This is typically done through a smart contract on blockchain platforms like OpenSea, Rarible, and NBA Top Shot Marketplace which allow creators to mint NFTs directly on their platforms.

For minting NFTs, conducting transactions or executing smart contracts, a fee called *gas fee* is imposed on the Ethereum network, which serves as compensation for the computational resources utilized in processing these actions. Gas fees, denominated in *wei*, which are small fractions of Ether (ETH) are used to incentivize miners who verify transactions by rewarding them for their computational resources and energy required to process and validate transactions [120]. They play a crucial role in preventing spam and frivolous activities on the network by imposing a cost barrier [42] and incentivize users to prioritize essential and legitimate transactions while discouraging unnecessary or malicious activities [30]. Additionally, gas fees contribute to the stability of the blockchain by adjusting based on the supply and demand for computational resources, preventing network congestion during peak periods [43][132].

Once an NFT is minted, it needs to be stored in a secure digital wallet, such as MetaMask, Trust Wallet, which generate and store the private key associated with the user's wallet address, which grants access to the NFTs. The NFT itself is stored on the blockchain, while the wallet keeps a record of the user's ownership and allows for easy access and management of the NFTs [24]. The wallet also provides the necessary interfaces to interact with NFT marketplaces for trading and transactions that occur on NFT marketplaces. When a buyer purchases an NFT, the ownership is transferred on the blockchain, and the transaction is recorded on the blockchain's public ledger, ensuring transparency and immutability (see Figure 5) [24].

Figure 5. How to mint an NFT

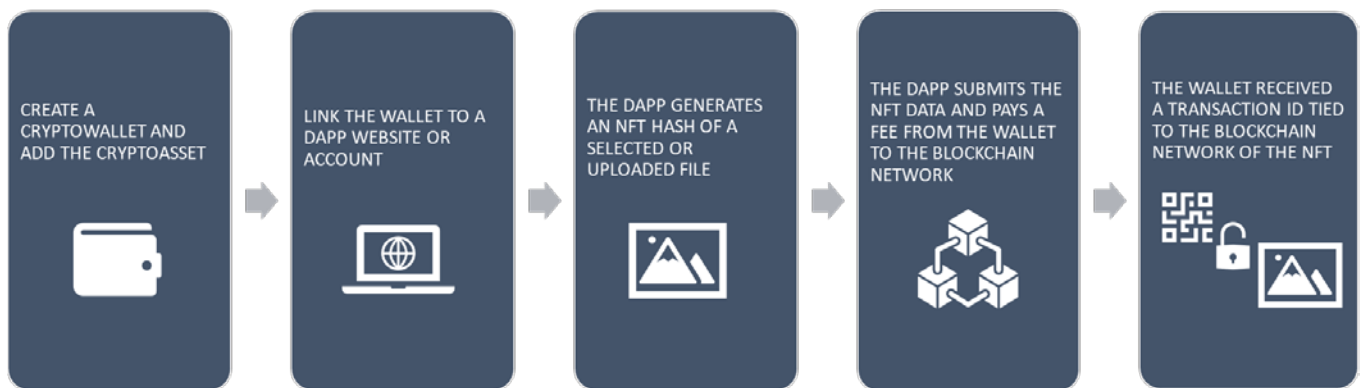

Source: own elaboration based on Rehm (2022) [106]

In the context of NFTs, the use of public and private keys plays a crucial role in ensuring the security and ownership of the digital assets. When an NFT is created, a unique pair of cryptographic keys is generated: a public key and a private key. On the one hand, the public key serves as an identifier or address that is visible to others on the blockchain network. It is used to verify the authenticity and ownership of the NFT. The public key can be shared openly and is used by others to interact with the NFT, such as purchasing, transferring, or displaying it [93]. On the other hand, the private key is kept securely by the owner of the NFT. It should never be shared with others as it grants access and control over the NFT. The private key is used to digitally sign transactions associated with the NFT, such as transferring ownership or making changes to the metadata. It ensures that only the rightful owner has the authority to perform these actions [93].

Figure 6. Functions of Public and Private Keys

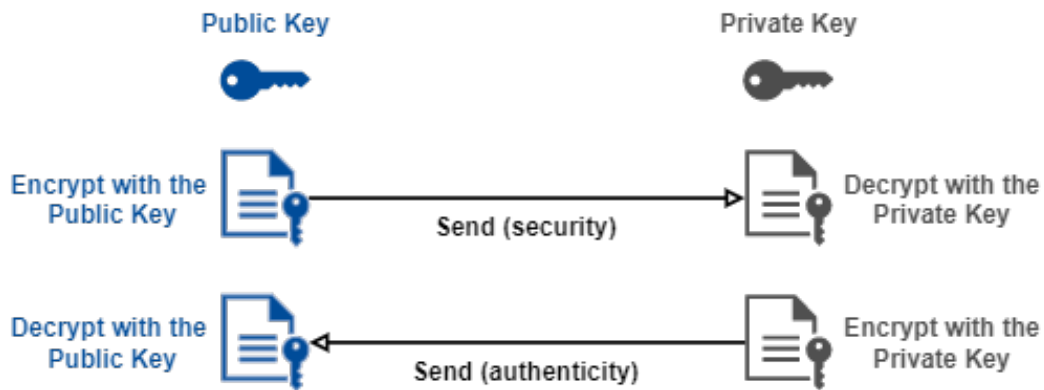

Source: Fulber-Garcia (2023) [94]

The interaction between the public and private keys establishes a cryptographic link that ensures the integrity and security of NFT ownership. The private key serves as a digital signature to authenticate and authorize transactions, while the public key provides a means for others to verify the ownership and validity of the NFT on the blockchain network [35]. It's important for NFT owners to protect their private keys and keep them secure. Losing or compromising the private key could result in the loss of ownership or control over the NFT. Various secure wallet solutions and best practices exist to safeguard private keys and ensure the safe management of NFTs [35].

### 2.2.2 NFT blockchain platforms and standards

The following lines will analyze the diverse NFT blockchain platforms that serve as the foundation for these unique tokens, including Ethereum, Binance Smart Chain, Flow, and others, as well as their own NFT standards. We examine their features, capabilities, and the impact they have on the NFT ecosystem including scalability, transaction fees, or other key factors.

- **Ethereum**

Ethereum stands as the longest-running and extensively tested smart contract platform that provides the infrastructure for creating and operating NFTs. It was created in 2014 and is considered the second generation of blockchain. Ethereum's programmable nature and support for smart contracts make it a popular choice for creating and trading NFTs [13]. Subsequently, in 2017, Larva Labs developed the first Ethereum-based NFT called CryptoPunks. This NFT contains 10,000 randomly generated human-like characters. The

official ownership of these characters is stored in smart contracts and owners can buy and sell them. That same year, this project inspired the creation of CryptoKitties, a blockchain gaming platform that pioneered NFTs and brought attention to this new type of digital asset. The CryptoKitties project was the first to implement the ERC-721 token, which became the first standard, free and open-source token to be developed and accepted on the Ethereum network.

ERC-721 is basically an interface that smart contracts must implement to transfer and manage NFTs. In ERC-721 smart contracts can include tokens of the same configuration, and each token has different properties, so their use is not extensible to fungible tokens. Each ERC-721 token has unique properties and a distinct 'Token ID', which includes the holder's information, a list of approved addresses and a function for token transferring ownership, transaction confirmation methods, and secure transfer handling in applications [101] which reduces the risk of forgery to zero [12]. Later, another standard was introduced, ERC-1155, which allows multiple non-fungible tokens to be grouped together in a single contract, resulting in lower transaction costs [102]. ERC-1155 has higher scalability since it is applicable to fungible, non-fungible, and semi-fungible tokens. Semi-fungible tokens are tokens that have characteristics attributable to both fungible and non-fungible tokens, meaning that they will have some qualities or others depending on the type of asset they represent and as a function of time (see Figure 7) [13].

*Figure 7. Fungible, Non-Fungible and Semi-Fungible tokens*

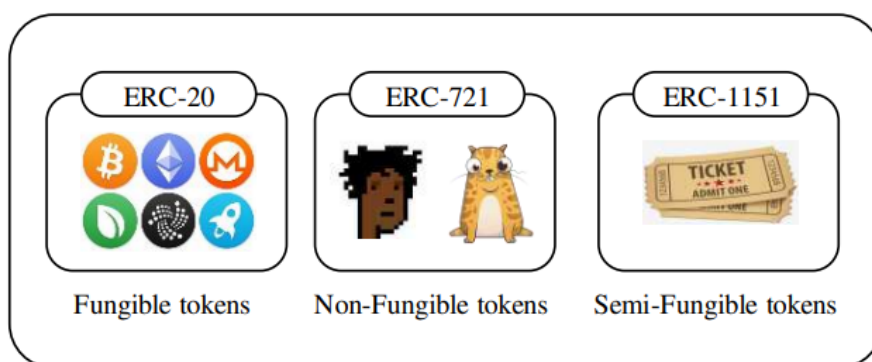

Source: Bakaman (2021) [12]

The reason behind the use of these standards is that ensure interoperability and consistency among different NFTs, allowing them to be easily created, bought, sold, and transferred within the Ethereum ecosystem.



However, as the popularity of NFTs grew, developers began creating and improving NFT standards like SOL, dGoods, Algorand, Tezos, and Flow on various blockchains, such as Solana, EOS, Algorand, and Tezos, among others. All these solutions will be analyzed as follows for the sake of selecting the most suitable blockchain platform for the development of the application for managing patents.

- **Solana**

Solana is a high-performance blockchain platform known for its fast, secure, and scalable solutions for decentralized applications (dApps) and cryptocurrencies. Founded by Anatoly Yakovenko in 2017, Solana launched its mainnet in March 2020 [117]. The platform's scalability is one of its key strengths, achieved through a combination of technologies.

Solana utilizes a proof-of-history (PoH) consensus mechanism which creates a historical record of events, facilitating fast and efficient transaction processing. Solana claims to handle thousands of transactions per second, making it one of the fastest blockchain platforms. Solana also distinguishes itself with low transaction fees, leveraging its high throughput capacity to keep costs minimal [117]. Solana's native cryptocurrency is SOL, which is integral to the network's operations, including transaction fees, staking, and consensus participation. SOL has experienced significant price appreciation and market capitalization growth, reflecting the increasing interest and adoption of Solana as a blockchain platform.

- **EOS**

In addition, there is EOS, which is a blockchain platform introduced in 2018 that aims to eliminate transaction fees and increase transaction throughput. It distinguishes itself from Ethereum through its wallet creation algorithm and transaction handling process. On the EOS blockchain, the dGood standard was developed as a free standard for assets, catering to large-scale applications. dGood supports a hierarchical naming structure in smart contracts, where each contract has a unique symbol and categories, and each category contains a list of token names. This hierarchy enables the inclusion of multiple tokens within a single dGood contract, facilitating efficient transfer of token groups. The dGood standard supports fungible, non-fungible, and semi-fungible tokens, as well as batch transfers for multiple tokens in a single operation.

- **Algorand**

Later, Algorand, launched in 2019, is a high-performance public blockchain that emphasizes scalability, security, and decentralization. It supports smart contracts and tokens for asset representation. Algorand introduces the concept of Algorand Standard Assets (ASA) to create and manage assets on its blockchain. Unlike other platforms, Algorand enables users to create NFTs or FTs without the need to write smart contracts. In Algorand, each account can create a maximum of 1000 assets, and for every asset created or received, the minimum balance of the account increases by 0.1 Algos. Algorand also supports fractional non-fungible tokens (NFTs) by dividing an NFT into multiple parts that can be exchanged independently. Algorand utilizes a Clawback Address, like the operator in ERC-1155, which has permission to transfer tokens on behalf of the owner.

- **Tezos**

Besides, Tezos is a decentralized open source blockchain that introduces the meta-consensus concept, aiming to achieve consensus not only on the ledger's state but also on protocol changes and upgrades. Within the Tezos blockchain, the FA2 (TZIP-12) standard provides a unified token contract interface, supporting various token types such as fungible, non-fungible, and fractionalized NFT contracts. Tokens in Tezos are identified by a combination of the token contract address and token ID. Tezos also facilitates batch token transfers, reducing the cost associated with transferring multiple tokens.

- **Flow**

Flow, developed by Dapper Labs, addresses the scalability limitations of Ethereum and focuses on games and digital collectibles. Flow is a fast and decentralized blockchain that enhances throughput and scalability without sharding. Smart contracts in Flow utilize the Cadence programming language, which is resource oriented. NFTs are represented as unique resource identifiers in Cadence, providing ownership assurance with restrictions on copying and loss. Flow allows metadata, such as images and documents, to be stored either off-chain or on-chain.

Additionally, Flow introduces the concept of Collections, which are NFT resources containing a list of resources in a dictionary-like structure, where each key represents a resource ID associated with its corresponding NFT.

- **Binance Smart Chain**

Finally, Binance Smart Chain (BSC) is a blockchain platform developed by the cryptocurrency exchange Binance. It aims to provide a high-performance and low-cost infrastructure for creating decentralized applications (dApps) and digital assets. BSC was launched in September 2020 and has gained significant popularity in the blockchain community. BSC is built as a parallel blockchain to Binance Chain, the original blockchain platform of Binance, with Binance Chain focusing on fast and secure trading, while BSC focuses on smart contract functionality and dApp development [21].

One of the key features of BSC is its compatibility with the Ethereum Virtual Machine (EVM), which allows developers to deploy and run Ethereum-based dApps on BSC with minimal modifications, expanding the range of applications that can be built on the platform, in addition to its low transaction fees. By using a PoSA consensus mechanism and a network of elected validators, BSC can achieve faster transaction confirmations and lower fees compared to the Ethereum network. This has made BSC an attractive option for developers and users looking for cost-effective solutions [22].

Binance Coin (BNB) is the native cryptocurrency of BSC. It plays a vital role in the BSC ecosystem, serving as a means of payment for transaction fees, participating in staking and governance, and facilitating token swaps within the BSC network [21].

## **2.3 Understanding Industrial Property: Patents**

### ***2.3.1 Overview of industrial property***

The field of industrial property legislation falls within the broader scope of intellectual property (IP) law, which include various forms of creative works generated by human intellect. Intellectual property rights are designed to safeguard the interests of inventors and creators by granting them exclusive rights over their creations [14]. The significance of safeguarding intellectual property (IP) was initially acknowledged through the Paris Convention for the Protection of Industrial Property in 1883 and the Berne Convention for the Protection of Literary and Artistic Works in 1886. These international treaties, administered by the World Intellectual Property Organization (WIPO), established frameworks for the protection of various forms of intellectual property [92].

Countries typically have laws in place to protect intellectual property (IP) for two primary purposes. Firstly, these laws aim to legally recognize and uphold the rights of creators and innovators in their works, while also considering the public's interest in accessing and benefiting from these creations and innovations. Secondly, IP laws are intended to foster an environment that encourages creativity and innovation, thus contributing to economic and social progress [47].

The principal categories of IP recognized are copyrights, patents, trademarks, and trade secrets [85]. However, IP is usually divided into two main branches, namely copyright, and industrial property [124]. On the one hand, copyright refers to the protection of literary and artistic works, containing a wide range of creative expressions such as books, music, paintings, sculptures, films, as well as technology-based works. Their purpose is to safeguard the rights of creators and provide them with exclusive control over the use and distribution of their works, preventing unauthorized copying, reproduction, or adaptation. On the other hand, industrial property includes various forms of intellectual property rights, such as patents, industrial designs, trademarks, commercial names, and protection against unfair competition, among others [125]. Although each of these forms of intellectual property rights serves a distinct purpose in safeguarding different aspects of innovation, creativity, and commercial interests, this study will only focus on patents.

Patents, commonly known as patents for inventions, are the predominant method of safeguarding technical innovations, which can be a product or a method that generally introduces a fresh approach to accomplishing something or presents a novel technical resolution to a problem. A product patent grants the right to prevent others from making, using, selling, or importing the patented product without the owner's consent. A process patent, on the other hand, grants the right to prevent others from using the patented process without permission and from using, selling, or importing products directly obtained through that process [78]. In simple terms, when a patent is granted by a state or a regional office representing multiple states, the patent owner gains the exclusive right to prevent others from commercially exploiting the invention for a specified duration, typically 20 years [98]. Essentially, the owner of a patent possesses the sole authority to prohibit or halt others from engaging in commercial activities involving the patented invention. This implies that without the patent owner's permission, the invention cannot be manufactured, utilized, distributed, imported, or sold by others.

Once the patent is granted, the owner of a patent has the option to grant permission or license to other individuals or entities, allowing them to utilize the patented invention under mutually agreed conditions in return for “royalty” payments. This process occurs based on mutually agreed terms and conditions, which may include specifying the payment amount and method from the licensee to the licensor. The terms also define the purpose for which the invention can be used, the geographical territory where it can be utilized, and the duration of the licensing agreement. Furthermore, the patent owner can choose to sell the rights to the invention, transferring ownership of the patent to a new party [97]. However, once a patent expires after the specified duration, the invention enters the public domain and becomes available for commercial use by anyone [131].

To obtain protection, the patent applicant must disclose the details of the invention (comparing their invention with existing technologies to demonstrate its novelty), and the enforceability of their rights is limited to the territory in which the patent was granted [137]. A patent can be obtained either from a national patent office or from a regional office that handles patent applications for multiple countries. In regional systems, an applicant can seek protection for their invention in one or more member states of the respective regional organization, and if the criteria for granting a regional patent are fulfilled, patents are issued accordingly. However, it is important to note that there is currently no global, universally applicable system in place for patent grants, and therefore, process and requirements for obtaining a patent may vary across different countries and regions.

In addition, not all inventions are eligible for patent protection, as they must fulfill certain conditions or requirements. These conditions include (1) being within the scope of patentable subject matter defined by national laws, (2) demonstrating industrial applicability or utility, (3) showcasing novelty by introducing new characteristics not known in the existing knowledge (prior art) of the technical field, and (4) exhibiting an inventive step that is non-obvious to a person with average knowledge in the field [96].

### ***2.3.2 The Patent system in Spain***

In Spain, the main entities responsible for patents are the Spanish Patent and Trademark Office (OEPM), the European Patent Office (EPO), and the World Intellectual Property Organization (WIPO).

The Spanish Patent and Trademark Office (OEPM) serves as the central authority for intellectual property rights in Spain. It plays a crucial role in granting and managing patents, trademarks, and other industrial property rights [118]. The OEPM conducts examinations to assess the novelty and inventiveness of patent applications, issues patents, and maintains the national patent register [118].

Besides, the European Patent Office (EPO) is another important entity for patent matters in Spain. While not specific to Spain alone, the EPO handles the granting of European patents, which provide protection in multiple European countries, including Spain [46]. Applicants can file a European patent application with the EPO, designating Spain as a designated country, allowing them to secure patent protection in Spain alongside other European nations [46]. The EPO's role is crucial in ensuring a harmonized patent system across participating European countries.

Finally, the World Intellectual Property Organization (WIPO) operates at the international level and plays a significant role in patent matters globally. WIPO is a specialized agency of the United Nations that promotes the protection of intellectual property rights worldwide [136]. It administers international treaties related to patents, such as the Patent Cooperation Treaty (PCT). Spanish applicants can utilize the PCT system, which simplifies the process of seeking patent protection in multiple countries, including Spain, by filing an international patent application [136]. WIPO contributes to fostering innovation and ensuring the recognition and protection of patents on a global scale.

To secure protection for an invention in other countries under the Paris Convention or the World Trade Organization, applicants can exercise the right of priority. This grants them a 12-month window from the initial filing in Spain to submit the application in other countries, with the Spanish filing date serving as the priority date for subsequent filings. Additionally, applicants using the European or PCT routes have the option to file in multiple countries simultaneously, extending their potential coverage to a significant number of nations (153 member countries). However, the current study will focus on the patents within the Spanish domain, in which the process of patent application involves two main procedures: the General Procedure and the Procedure with Prior Examination.

The General Procedure, widely used in practice, grants a patent without conducting an extensive examination of its patentability. On the other hand, the Procedure with Prior Examination offers additional features, including a thorough analysis of the novelty and inventive step of the invention, as well as the opportunity for third parties to file oppositions against the patent application. Both processes are explained in detail below. However, either way, the process of granting the patent will not take less than thirty months. [41].

- **General Procedure:** This is the most commonly used procedure at present. After filing the corresponding patent application and obtaining the Report on the State of the Art (RSA), the patent application is granted without conducting a patentability examination. In this procedure, no oppositions are allowed, but observations regarding the application can be submitted. If the applicant does not choose the other procedure (with prior examination) within a period of 3 months, the Spanish Patent and Trademark Office (OEPM) will automatically follow the general procedure.
- **Procedure with Prior Examination:** This procedure is optional and has additional features compared to the general procedure. After receiving the Report on the State of the Art (RSA), a thorough examination of the patentability of the invention is conducted. This includes a detailed analysis of the novelty and inventive step of the invention. During this procedure, oppositions can be filed against the patent application. If the patentability examination is negative or if the oppositions are accepted, the patent application will be rejected.

While the General Procedure and the Procedure with Prior Examination have some differences, they also share common initial stages in the patent application process. However, since the General Procedure is the most widely used, it is the one that will be analyzed in detail. According to the information provided by the Spanish Patent and Trademark Office (OEPM) retrieved from the “Patent Applicant Manual” [96] these are the stages in the general patent application process in Spain:

### **1. Admission and granting of filing date**

The documentation that comprises the patent application consists of the following documents:

Analysis of Non-Fungible Tokens (NFTs) from an Industrial Property perspective.

- a) Application form: It should include the title of the invention (not fantasy names or trademarks), identification data of the applicant and representative (if applicable), including their name, address, nationality, and signature.
- b) Description of the invention.
- c) One or more claims.
- d) Summary of the invention.
- e) Figures.

Within ten days after receiving the patent application at the Spanish Patent and Trademark Office (OEPM), the application is examined to determine if it meets the requirements for granting a filing date and if the corresponding fees have been paid. If the requirements are met, the filing date will be the initial date of submission. If there are deficiencies, they are notified to the applicant, who is given a period of two months to correct them, or one month in the case of failure to pay the filing fee. Failure to do so will result in the application being considered abandoned.

If the identified defects are corrected, the filing date is modified to the date of submitting the corrected documentation (Article 15 Reg. modified by R.D. 441/1994), unless the corrected defect is the payment of the fee, in which case the original filing date is retained.

Although the provision of claims and a summary of the invention is not required to obtain a filing date, it is mandatory in subsequent phases. Therefore, it is recommended to submit them along with the rest of the documentation at the beginning of the application. Additionally, the figure(s) to be published with the summary should be indicated for a better understanding of the invention being claimed.

## **2. Formal and technical examination of the application**

Once the filing date has been granted, if the subject matter of the application is not deemed potentially relevant to national defense interests, it proceeds to the examination of the application in accordance with Article 31 of the Patent Law and Article 17 of the Implementing Regulation.

If there are any defects, the Spanish Patent and Trademark Office communicates them to the applicant, who has a period of two months to correct them. If the applicant fails to do so, the patent is denied. The documentation should be sent to the OEPM, clearly



indicating the application number, to ensure proper registration upon arrival. Responding to the objection requires payment of the corresponding fee.

### **3. Continuation of procedure**

If the application does not contain any defects or once they have been corrected, the OEPM notifies the applicant, through a notification of continuation of the procedure, to request the preparation of the Report on the State of the Art (RSA). The request must be made in writing (for which the Office has a specific form, the "RSA1"), and unless the application benefits from fee deferral or exemption, the corresponding fee must be paid.

Both the request and fee payment can be made within fifteen months from the filing date or within one month from the communication of the OEPM requesting the request. Failure to request the RSA or to pay the corresponding fee will result in the application being considered withdrawn.

### **4. Preparation of the report on the state of the art**

Once the RSA has been requested, the OEPM prepares the report and then notifies the applicant of the report and all the documents cited in it.

### **5. Publication of the application**

Eighteen months after the filing date or priority date, if applicable, and once the technical examination has been passed, the OEPM makes the patent application available to the public in its databases and publishes the corresponding announcement in the Official Industrial Property Gazette (BOPI). If the RSA has already been prepared, it will be published at the same time; otherwise, it will be published subsequently.

### **6. Publication of the RSA. procedure interruption**

The mention of the publication of the RSA in the BOPI leads to the interruption of the granting procedure for a period of three months, during which the applicant has the following options:

- Request for a substantive examination.
- Request for the continuation of the general granting procedure.

Both requests must be made in writing (for which the Office has specific forms, EP1 and EP2, respectively). If none of these actions is taken, the OEPM will proceed ex officio to the continuation of the general granting procedure after the specified period.

**7. Resumption of the general granting procedure. third-party observations**

In both cases, when an explicit request is made or ex officio action is taken, the OEPM publishes the mention in the BOPI that the general granting procedure has been resumed. With this publication, a two-month period is opened for any third party to make reasoned and documented observations on the novelty and inventive step of the invention.

**8. Transmission of observations. modification of claims**

After the observation period, the OEPM informs the applicant of the observations and grants an additional two-month period for the applicant to make any relevant observations to the RSA, provide comments on the observations made by third parties, and make modifications to the claims if deemed necessary to overcome any lack of novelty or inventive step. It should be noted that modifications to the claims cannot extend the scope of the invention.

**9. Grant of the patent**

At the end of the specified period, the Office examines, if applicable, the modified claims. If the new claims cannot be accepted due to an impermissible extension or modification of the subject matter of the invention, the OEPM notifies the applicant to submit any necessary arguments within a period of 10 days.

Finally, regardless of the content of the Report on the State of the Art and the submitted observations, the OEPM proceeds to grant the patent, announcing it in the BOPI and making the granted patent documents, along with the RSA and all related observations and comments, available to the public. Granting the patent involves the payment of the granting fees, and once they are paid, the corresponding Patent Certificate is issued.

### **3. Specific literature review: Patents as NFTs**

In recent times, the convergence of patents and Non-Fungible Tokens (NFTs) has sparked interesting possibilities within the intellectual property. However, since it is not an established reality, there is still no legal nor technical framework for managing patents as NFTs. For this reason, this chapter further delves into the concept of patents as NFTs, analyzing the implications, potential benefits, and challenges associated with managing patents in this digital form.

### **3.1 Legal considerations for managing patents as NFTs**

As it has been explained in previous chapters, the general process after an NFT has been minted is as follows. Initially, a minter establishes a wallet on a marketplace to store their newly created NFT. When the marketplace receives payment, the NFT becomes associated with the underlying asset, which is stored in a different location. Subsequently, the NFT, which symbolizes ownership of the asset, is published, and added to the minter's wallet. At this point, the NFT can be transferred to others.

However, due to the intellectual property (IP) rights held by owners, such as the right to use, sell, and reproduce the underlying IP asset, there may be restrictions on who can create or distribute it as an NFT. In fact, although NFTs are commonly traded on online marketplaces like OpenSea and Rarible, if an online marketplace mints the NFT on behalf of a creator, they may require rights to reproduce and distribute the underlying asset as an NFT [85]. Without a license, the marketplace would infringe on the copyright owner's exclusive right to make copies by creating the NFT.

This is why in the context of NFTs, intellectual property (IP) concerns often arise when the creator of the NFT and the owner of the underlying asset are different individuals or entities since issues such as ownership and potential infringement may come into play. These concerns are resolved when the minter themselves creates the underlying IP asset to be used as an NFT, thereby holding the IP rights to the asset. Alternatively, if the owner of the asset assists in the creation of the NFT and gives consent for the use of its IP, these concerns can also be addressed [85].

On the other hand, when you purchase an NFT, you are primarily acquiring ownership rights to the NFT itself, but not the associated intellectual property (IP) rights. This means that you do not automatically gain the rights to the underlying digital content of the NFT. Just like when you buy a physical item, your ownership is limited to the item itself and does not extend to the IP associated with it [5]. However, the buyer can display the copy and potentially assign or sell it through a license.

NFT licenses are typically established through the sales terms or relevant laws, and most of them directly pass rights from the IP owner to the buyer. The terms of the NFT sale should clearly outline the IP rights, buyer's and seller's rights, and any licenses involved. For instance, the terms may transfer all IP rights of the underlying asset, include a license

in the NFT's marketplace description to govern the buyer's usage, or be governed by smart contracts that entitle the IP owner to resale and royalty fees for future transfers of the NFT [85]. Moreover, NFT platforms typically allow creators to specify the rights associated with their NFTs in the listing description.

However, the enforceability of these terms may vary and depend on the applicable laws. Because the legal framework for NFTs is still evolving, most jurisdictions still do not have specific laws or regulations governing NFTs [5]. This is because IP rights assignments typically need to be officially recorded with the relevant registry, such as the US Patent and Trademark Office (USPTO) to be enforceable against third parties. In addition, the decentralized nature of blockchain servers adds another layer of complexity. With servers located in different jurisdictions, identifying legal breaches and taking cross-border measures can be challenging. As the technology and legal landscape continue to develop, it will be important for both users and authorities to navigate these complexities and address any legal implications associated with NFT transactions [5].

Therefore, when managing IP as NFTs stakeholders should first consider (1) the rights required for creating and selling the NFT, (2), the IP rights associated with the underlying asset, if any, that are being transferred through either a sale or a license, (3) the specific details of the IP transfer, including its scope and limitations, and (4) the terms and conditions governing the transfer of the NFT itself [85].

### **3.2 Decentralized conceptual framework for managing patents as NFTs**

Although some work is being done in this matter, there is still no publicly available or standardized framework for minting and managing patents as NFTs. However, the most well-known conceptual framework was introduced by Prof. QU Qiang from the Shenzhen Institute of Advanced Technology (SIAT) in collaboration with Prof. Seyed Mojtaba Hosseini Bamakan from Yazd University [12]. Such hierarchical conceptual framework is divided into the following five layers: Storage Layer, Authentication Layer, Verification Layer, Blockchain Layer, and Application Layer (see Figure 8) and will be explained in detail below. The idea is to use it as a base for the own framework that will be developed subsequently.

Figure 8. Architecture of the decentralized conceptual framework

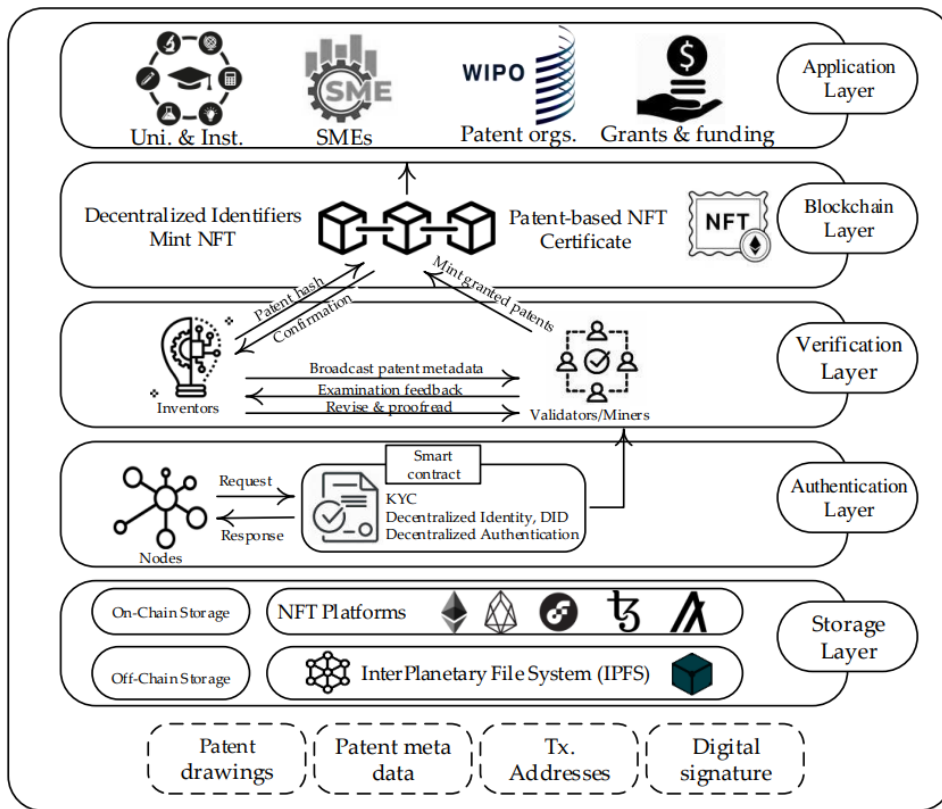

Source: Bamakan (2021) [12]

### a) Storage Layer

The increasing prominence of blockchain technology has prompted various information systems to embrace decentralized storage networks. These networks offer several advantages to the tech world [17]. Firstly, they enable cost savings by maximizing the utilization of existing storage resources. Secondly, by maintaining multiple copies across different nodes, decentralized storage systems prevent congestion on central servers and enhance download speeds. This foundational layer establishes the necessary infrastructure for storage.

Non-fungible token metadata serves as the information that describes a specific token ID. This metadata can be either stored on-chain or off-chain. On-chain storage involves directly incorporating the metadata into the NFT's smart contract, which represents the tokens. Conversely, off-chain storage entails hosting the metadata separately [84].

In addition, while blockchains offer decentralization, they come with drawbacks such as costly data storage and the inability to remove data once it is recorded. This limitation is

evident in the case of the Ethereum blockchain, which has storage limitations and high maintenance costs. As a result, many projects choose to store their metadata off-chain. To facilitate this, developers make use of the ERC721 Standard, which incorporates a method called tokenURI. This method enables applications to locate the metadata associated with a specific item. Currently, there are three prevalent solutions for off-chain storage: the InterPlanetary File System (IPFS), Pinata, and Filecoin.

- **IPFS**

The InterPlanetary File System (IPFS) is a decentralized storage protocol designed for peer-to-peer hypermedia. It offers an affordable and efficient solution for storing media files associated with NFTs on the blockchain. IPFS incorporates various technologies, including the Block Exchange System, Distributed Hash Tables (DHT), and Version Control System [16]. Within a peer-to-peer network, DHT is utilized to coordinate and maintain metadata, ensuring that hash values correspond to their respective objects.

When storing an object like a file, IPFS generates a hash value starting with the prefix *Qm*, acting as a unique identifier. Furthermore, asymmetric encryption can be employed to safeguard stored content on IPFS, preventing unauthorized access [91]. Asymmetric encryption, or public-key encryption, uses a pair of keys: a public key, which is shared openly and is used to encrypt data and verify digital signatures, and a private key, that kept secret and used to decrypt encrypted data and create digital signatures. This technique enables secure communication and data exchange without the need for a shared secret key [9].

- **Pinata**

Pinata is a widely used platform that facilitates file management and uploading on IPFS. In the case of most NFTs, the actual data is stored off-chain, with the blockchain containing a URL pointing to the data. However, this approach introduces a challenge as certain aspects of the URL can be modified, potentially undermining the integrity of the NFT. This is where Pinata proves valuable.

Pinata utilizes IPFS to create Content-Identifiers (CIDs), which are content-addressable hashes of data. These CIDs serve two purposes: retrieving data and ensuring data validity. When someone requests data, they simply ask the IPFS network for the data associated with a specific CID. If any node in the network possesses the data, it is returned to the

requester. To verify the authenticity of the received data, it is automatically rehashed on the requester's computer, ensuring it matches the original CID. This process guarantees that the received data is exactly what was requested. If a malicious node attempts to send fraudulent data, the resulting CID on the requester's end will be different, alerting them to the presence of incorrect data. By leveraging Pinata and IPFS, the proposed architecture ensures the reliable presentation of NFT-based patents, protecting the integrity of the associated information and enhancing trust in the system [123].

- **Filecoin**

Filecoin is another decentralized storage network that operates on top of IPFS and focuses on storing critical data, including media files. Truffle Suite (a collection of development tools designed to aid developers in building, testing, and deploying decentralized applications (dApps) and smart contracts on blockchain platforms) has introduced the NFT Development Template with Filecoin Box, providing developers with tools for building NFT applications [86].

NFT.Storage, a service supported by Protocol Labs (the team behind IPFS) and Pinata, offers free decentralized storage for NFTs using IPFS and Filecoin. It enables developers to securely store NFT content and metadata, ensuring compliance with best practices for long-term accessibility. NFT.Storage simplifies the process of minting NFTs and facilitates resilient persistence on IPFS and Filecoin. By leveraging this service, developers can easily store NFT data on decentralized networks without any cost [103].

The NFT.Storage system operates based on the following principles [13]:

- *Content Addressing*: Upon uploading data to NFT.Storage, users receive a CID (IPFS hash) that serves as a unique identifier for the content. CIDs are generated from the content itself, ensuring robust referencing and avoiding issues such as weak links or fraudulent actions.
- *Provable Storage*: NFT.Storage utilizes Filecoin for long-term decentralized data storage. Filecoin employs cryptographic proofs to guarantee the durability and persistence of NFT data over time.
- *Resilient Retrieval*: The data stored through IPFS and Filecoin can be directly fetched in a web browser using any public IPFS gateway.



### **b) Authentication Layer**

The second layer, referred to as the authentication layer [29], plays a significant role in the framework. The Decentralized Identity (DID) approach (28) enables users to collect credentials from various issuers, such as the government, educational institutions, or employers, and securely store them in a digital wallet. Verifiers can then utilize these credentials to verify a person's validity by employing a blockchain-based ledger and following the "identity and access management (IAM)" process. This approach puts users in control of their identity.

The lack of verifiability in NFTs (29) leads to issues related to intellectual property and copyright infringements. Although the chain of custody can be traced back to the creator's public address, there is no quick and foolproof way to verify the legitimacy of an NFT's creator. Without proper verification built into the NFTs, ownership is limited to the NFT itself and does not extend beyond that. To address this challenge, self-sovereign identity (SSI) [121] offers a solution. SSI is guided by a series of new standards that define an identity architecture for the Internet. It focuses on privacy, security, and interoperability.

SSI applications utilize public-key cryptography with public blockchains to generate persistent identities for individuals while allowing for selective information disclosure. The blockchain technology employed ensures trust, transparency, and a secure and publicly verifiable KYC (Know Your Customer) process. The blockchain architecture facilitates the consolidation of information from various service providers into a single, cryptographically secure, and unchangeable database, eliminating the need for third-party verification.

In the proposed framework, patents-related smart contracts [76] act as programs running on the blockchain, enabling the receipt and sending of transactions. These smart contracts incorporate thorough KYC processes to ensure the authenticity of the involved clients. Once approved, an NFT is minted on the blockchain as a certificate of verification for the patent. At this layer, a decentralized authentication solution [55][70] is employed to handle authentication. This solution has been successfully utilized in various blockchain applications, including smart cities and the Internet of Things, and is now applied to the proposed patent-as-NFT framework.

The authentication layer [139], aims to establish secure and decentralized communication using blockchain technology. It consists of two main processes: registration and login, as illustrated in Figure 9.

Figure 9. Decentralized authentication

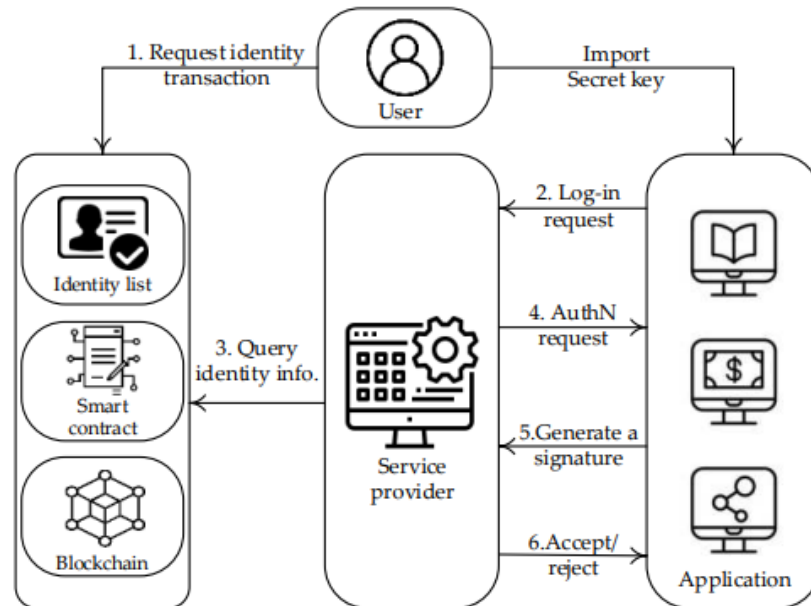

Source: Bamakan (2021) [12]

During the registration process, a user's public key is initialized as their identity key (UserName). This identity key is then uploaded onto the blockchain, allowing other users to verify transactions associated with it. Finally, the user generates an identity transaction. Once registered, a user can proceed with the login process, which involves the following steps:

1. The user provides their identity information and imports their secret key into the service application for authentication.
2. The user sends a login request to the network's service provider.
3. The service provider analyzes the login request, extracts the hash, queries the blockchain, and retrieves identity information from the identity list (identity transactions).
4. Upon completing the above steps, the service provider sends an authentication request, which includes a timestamp (to prevent replay attacks), the user's UserName, and a signature.

5. The user creates a signature using five parameters: timestamp, UserName, PK (public key), as well as the UserName and PK of the service provider. This user authentication credential serves as the signature.
6. The service provider verifies the received information, and if it is valid, the authentication process succeeds, granting the user access. Otherwise, if the information is invalid, the authentication fails, and the user's login is denied.

### c) **Verification Layer**

In permissioned blockchains, only identified nodes have the authority to read and write in the distributed ledger. This ensures that patent granting offices serve as the identified nodes in a distributed system. The system consists of four levels, like it can be seen in Figure 10.

1. *Digitalization*: To publish a patent as an NFT on the blockchain, it needs to be in a digital format. This level corresponds to the traditional step of filling out a patent application. An application can be designed to allow users to enter patent information online.
2. *Recording*: Patents contain valuable information that could be exploited if publicly published in the blockchain. To prevent this, the inventor first privately records their innovation using proof of existence. The inventor generates a hash of the patent document and records it in the blockchain. The timestamp and hash become publicly available, enabling the inventor to prove the existence of the patent document. Each phase of patent development can be separately recorded using methods like Decision Thinking, creating a series of hashes that indicate the patent's development stages [94][98].
3. *Validating*: In this phase, inventors create NFTs for their patents and submit them to miners/validators. Miners, who are identified nodes specialized in patent validation, ensure the integrity of the NFTs before recording them in the blockchain. Since patent offices are limited in number, certified specialists from these offices can act as miners. They receive digital certificates from the patent offices, establishing their eligibility to referee patents.
4. *Digital Certificate*: Digital certificates are used to verify the online identities of networked entities. They contain a public key and owner's identification and are issued by Certification Authorities (CAs). In the context of patent validation, the

patent office creates a certificate for requested patent referees. The validator's information is written in the certificate and encrypted using the patent office's private key. The certificate can be used by the validator to prove their eligibility, and other nodes can decrypt it using the patent office's public key to verify the requesting node's information.

Figure 10. Verification Layer sequence diagram

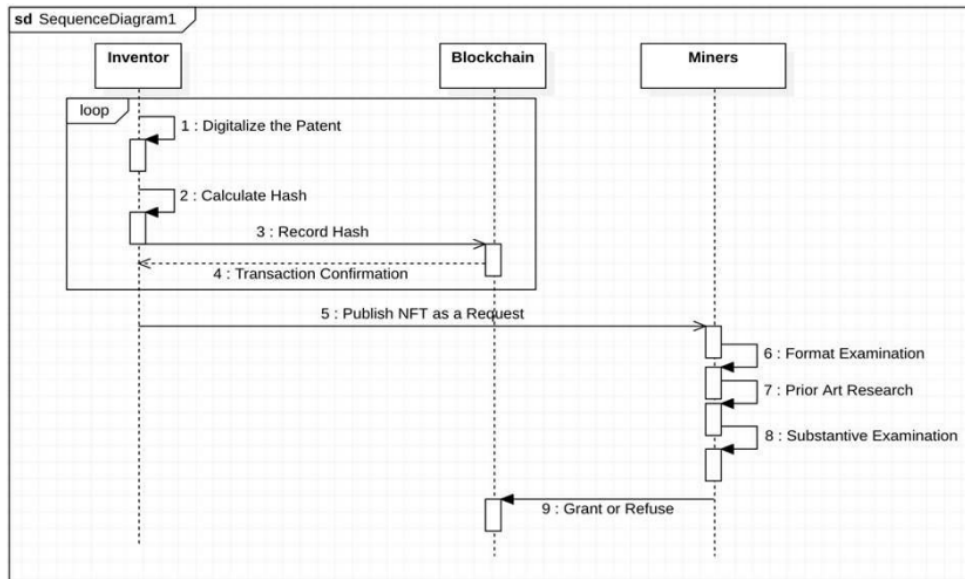

Source: Bamakan (2021) [12]

In this phase, miners perform examinations, research, and voting to grant or refuse the patent. Once a consensus is reached among the miners, the patent is recorded in the blockchain as an NFT. Comments regarding the grant or need for reformations accompany the recorded NFT. If miners identify the NFT as a malicious request, it is not recorded in the blockchain.

#### d) Blockchain Layer

The proposed architecture includes a layer that acts as a middleware between the Verification Layer and Application Layer in the patents as NFTs system. Its primary purpose is to provide IP management by utilizing blockchain technology. This transition to a blockchain-based patent as NFTs records system offers various improvements to the existing patent systems, such as flexibility, scalability, and transparency.

There are multiple blockchain platforms available for use, including Ethereum, EOS, Flow, and Tezos. Blockchain Systems can be categorized into two main types based on

their consensus mechanism: Permissionless (public) and Permissioned (private) Blockchains. In a public blockchain, any node can participate in the decentralized network without requiring consent from other nodes. Bitcoin is a well-known example of a public and permissionless blockchain, utilizing consensus algorithms like Proof of Work (PoW) and Proof-of-Stake (PoS). Private blockchains, on the other hand, require specific access or permission for network authentication. Hyperledger is a popular private blockchain that allows only permissioned members to join, ensuring security and trust among entities. Byzantine-fault-tolerant (BFT) consensus is commonly used in permissioned blockchains, which refers to the ability of a network or system to continue functioning even when some components are faulty or have failed [3]. Examples of permissioned blockchains include Hyperledger, Quorum, Corda, and EOS [94, 91, 94]. The proposed patent as NFTs platform aims to empower the entire patent ecosystem by addressing fundamental issues within the traditional patent system. Blockchain technology enables efficient handling of patents and trademarks, reducing approval wait times and required resources. The key user entities involved in Intellectual Property management are Creators, Patent Consumers, and Copyright Managing Entities. Creators, such as inventors, writers, and researchers, own the original data. Patent Consumers are users who consume and support the content created by the creators. Copyright managing entities, like lawyers, are responsible for protecting the creators' intellectual property.

The patents as NFTs solution for IP management in the blockchain layer follows specific steps [93]:

1. Creators sign up to the platform, providing their identity information.
2. Creators upload their intellectual property onto the blockchain network, ensuring traceability and preventing data manipulation.
3. Consumers register on the blockchain network and request access to the patented content. A Smart Contract is created to enable access, and consumers are required to pay fees.
4. The patent owner reviews the request, and once approved, a Non-Disclosure Agreement (NDA) is signed between the parties. The blockchain manages the agreement, ensuring compliance with the terms and conditions.
5. Patent management entities leverage blockchain to protect copyrights and resolve related disputes, including issues like unauthorized use of inventions.

In summary, the proposed architecture utilizes a middleware layer for patents as NFTs, with the blockchain layer providing IP management. Different types of blockchains can be used, and the platform aims to empower the patent ecosystem by addressing existing challenges. The process involves creators signing up, uploading their IP, consumers requesting access, and patent management entities leveraging blockchain for protection and dispute resolution.

#### **e) Application Layer**

Many enterprises, governments, universities, and SMEs worldwide are already utilizing Global Patent Marketplace technology to tokenize patents as NFTs. This technology enables storing patent records on a blockchain-based network and establishing a decentralized marketplace for patent holders to sell or monetize their patents more easily. NFT-based patents utilize smart contracts to set prices for licensing or purchases. Buyers satisfied with the conditions can pay and immediately gain rights to the patent, all without direct interaction between parties.

While patents are currently regulated jurisdictionally, a blockchain-based patent marketplace using NFTs can overcome geographical barriers through simple search queries. This increased access to patents globally can accelerate the innovative process by allowing inventors to build upon existing patented inventions through licenses. Patent NFTs have various use cases, including event ticketing, SMEs, patent organizations, and grant funding. These applications continue to grow, and new ways to utilize these tokens are constantly being discovered.

For SMEs, the goal is to digitize and secure intellectual property assets on a centralized blockchain network, making it easier for patents, particularly those held by small or medium enterprises, to be commercialized. Smart contracts can be attached to NFTs, outlining and agreeing upon terms of use and ownership without the need for extensive legal fees. This is expected to help SMEs secure funding by leveraging the previously undisclosed value of their patent portfolios [92].

Although this framework serves as a good example of what an ideal patent system based on the Blockchain would be. However, there are several challenges which will be addressed in the following chapter.

#### **4. Proposal of a hybrid framework for managing patents as NFTs**

This chapter presents the development of a hybrid framework incorporating the blockchain technology with the existing traditional patent system for the management of patents as Non-Fungible Tokens (NFTs). The limitations of previous frameworks will be challenged and benefits of centralization versus complete decentralization will be explored. In addition, the proposed architecture is deeply explained together with the development of the smart contract ruling the framework. This chapter provides valuable insights into the development of a robust and practical centralized framework for managing patents as NFTs, ultimately contributing to the overall advancement of intellectual property management.

## **4.1 Proposed framework architecture**

In the current landscape, a fully blockchain-based patent system, like the one proposed by Bakaman [12] in the previous chapter, may be considered unrealistic due to several challenges and limitations. While the blockchain offers numerous benefits such as enhanced security, transparency, and decentralized data management, it is still a relatively new technology that requires further development and widespread adoption to reach its full potential. Additionally, the legal framework and regulatory environment for managing patents entirely on the blockchain are yet to be established in most jurisdictions.

Considering these factors, a more pragmatic approach is to propose a hybrid patent system that combines the strengths of both the traditional patent system and blockchain technology. By integrating blockchain elements into the existing patent framework, we can leverage the efficiency and immutability of the blockchain for patent transactions, maintenance, and authentication. This hybrid model ensures a smooth transition while addressing the current limitations of a fully decentralized system. This way, the hybrid patent system allows patent offices to continue performing pre-issuance tasks using the well-established procedures and expertise of the traditional system. At the same time, by adopting blockchain for post-issuance activities, we can benefit from automated and secure smart contracts to manage patent rights, enforce licensing agreements, and streamline royalty payments. Moreover, the hybrid approach acknowledges that certain patent-related operations, such as patent examination, require human expertise, which cannot be entirely replaced by blockchain technology at this time. By striking a balance between the two systems, we can maximize the advantages of blockchain while maintaining the necessary human input to ensure the accuracy and reliability of the patent evaluation process.

For these reasons, the proposed framework for managing patents will consist of several layers that will be explained below (see Figure 11).

### **1. Patent application layer**

Pre-issuance activities will continue to be conducted using the traditional approach with its existing implications. Inventors will have the option to apply for their patents through



an online application portal that will allow inventors to submit their patent applications electronically, reducing paperwork and administrative burdens.

Once the patent application is received through the online portal, it will undergo the standard pre-issuance examination process carried out by patent examiners. These examiners will assess the patent application's novelty, non-obviousness, and industrial applicability in accordance with the established legal and technical criteria. This examination phase remains essential to ensure that only valid and worthy inventions receive patent protection, maintaining the quality and integrity of the patent system.

During the examination phase, inventors will be able to interact with the patent office in the traditional manner, addressing any queries or requests for additional information that may arise during the evaluation process. This direct communication between the inventors and the patent office allows for clarifications and ensures that the inventors' rights are adequately protected. This process would culminate in the grant of the patent, as only "accepted" patents would be converted into NFTs.

Figure 11. Proposed framework architecture

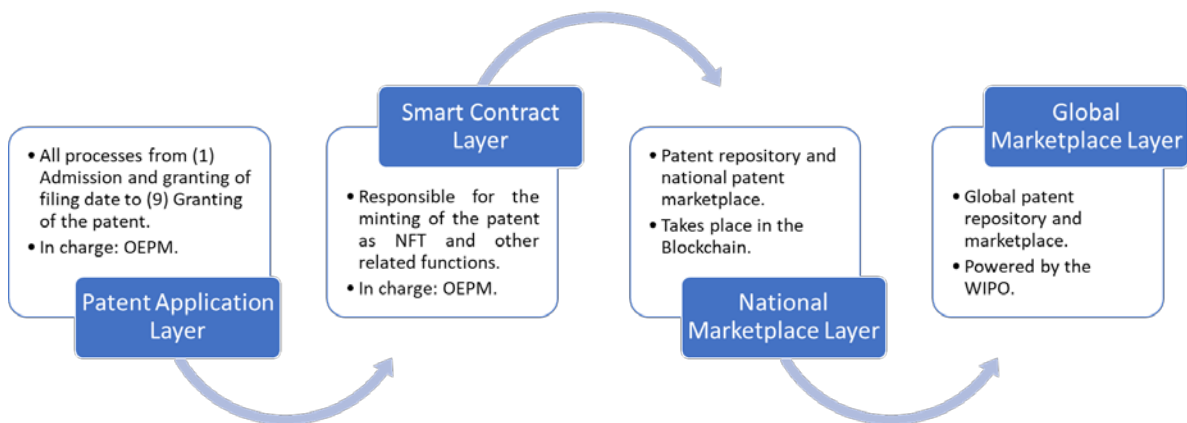

Source: own elaboration

## 2. Smart Contract layer

The Spanish Patent and Trademark Office (OEPM) is the sole entity authorized to issue and manage patents and will create a Smart Contract for this purpose. The Smart Contract will have the ability to issue NFTs representing patents and conduct transactions with them. In addition to the standard ERC-721 functionality, the Smart Contract will include

specific characteristics or functionalities for patent management, such as the issuer's name, patent title and description, creation timestamp, issuing country, etc.

Once a patent is approved, the OEPM will send an "order" to the Smart Contract to mint the corresponding NFT, with ownership belonging to the inventor. From this point forward, the NFT will exist on the blockchain, and its owner will have the freedom to trade it. Moreover, the Smart Contract will include functionalities so that each time a transaction occurs with the corresponding NFT, the patent owner receives royalties and a percentage of any future sale.

### **3. National marketplace layer**

This layer will serve as an application or user-interface layer to communicate users with the blockchain. It would work as follows: when a request to view the patent as an NFT is received from a wallet within a platform like OpenSea, if the wallet is "authorized," the Smart Contract will provide the storage address where the metadata is located, enabling the visualization of the patent document. The metadata would be stored in a centralized server like it is done nowadays or in a decentralized cloud storage system such as IPFS. Similar to traditional patents, which are also public and accessible to everyone, patents in the form of NFTs would be available in the blockchain making up an open repository of active patents, just as one can access the OEPM's INVENES tool and view any patent and its associated data, as both are public databases. In this case, there would be no need to pay gas fees to request information from the blockchain. Technically speaking, this is referred to as a GET or READ operation, as it does not change the state of the blockchain, which has a cost of zero. Operations involving POST (create) and PUT or UPDATE (modify) data are the ones that necessarily incur gas fees.

### **4. Global marketplace layer**

To create a kind of global patent repository, the OEPM could establish a platform/marketplace (similar to OpenSea) for trading patents as NFTs. In fact, it would be possible and highly recommended for all patent organizations in each country to be "authorized users" within a sort of whitelist (WL), thereby creating a global repository and marketplace. Each authorized entity could have its own patent smart contract, which could then be consolidated on a single platform, where all patents registered through this medium could be visualized and traded. This would be valuable because the ultimate purpose of the blockchain is always interoperability and universality. The more restricted

the use of a blockchain or the scope of an application, the lower its value and that of the digital assets.

If patent offices from various countries transition to a blockchain-integrated patent system, the possibility of a global interconnected, secure, traceable, and scalable patent system becomes achievable. By leveraging the blockchain, a distributed ledger technology, patents can be recorded and managed in a transparent and immutable manner. Such a system would enable seamless collaboration and information sharing among patent offices worldwide, ensuring efficient examination processes and reducing the likelihood of duplication or disputes. Moreover, the blockchain is a technology that is still in its early stages, offering immense potential for further development and innovation. Its decentralized nature and cryptographic security provide a strong foundation for building a future-proof global patent system that can adapt to evolving needs and advancements in technology. By transitioning to the blockchain, the international patent community can unlock the possibilities of a truly transformative and impactful patent ecosystem.

*Figure 12. Global Patent System*

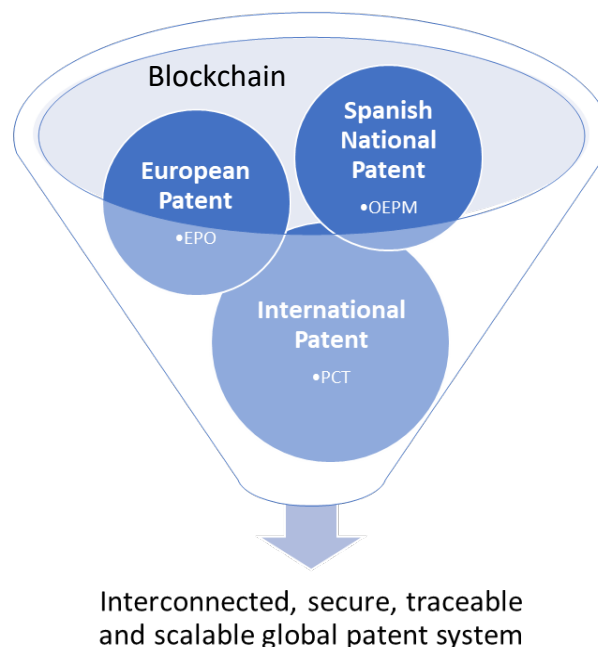

Source: own elaboration

## **4.2 Smart contract for managing patents as NFTs**

### **4.2.1 ERC-721 Smart Contract**

In order to understand what the proposed smart contract, it is of paramount importance to understand what a standard smart contract does. Once this is clear, one should know that the first step in making an NFT or a collection of them is to create a smart contract. NFTs are often called ERC-721 tokens, which is the standard for NFTs, providing a predefined and standardized way to create unique tokens. This is because although blockchain technology is still in its early stages, standards have emerged that simplify development and innovation in areas like NFTs. ERC-721 is a smart contract that sets the basic rules for NFTs, such as user balances, ownership addresses, token circulation, and transfers. This way, creating an ERC-721 token guarantees compliance with these rules and ensures it behaves like any other ERC-721 token.

The code for ERC-721 is openly accessible (included in Annex I), allowing users with technical knowledge to launch new NFT collections on the blockchain quickly. While basic functionality is easily implemented, more complex features and metadata, like images and attributes, consume more resources. ERC-721 can be extended with additional functionality through modules, similar to adding extras to a standard car. Users can choose or develop extra functions for their NFT collections and implement them in their smart contracts (which is what has been done in this case by adding functionalities to manage patents). It's important to note that although new functionalities are added to smart contracts, the foundation remains the ERC-721 standard. The behavior of NFTs is extended, not replaced. Once the smart contracts are ready, they are deployed to the blockchain as a single file, with corresponding gas fees or commissions.

However, for understanding smart contracts it is important to understand NFTs first. Merely having the contract address of an NFT collection is insufficient for complete identification of each token. To differentiate between NFTs within the same collection, the ERC-721 standard employs the concept of a token ID. This token ID is typically a numerical value that increases incrementally, serving as a unique identifier for each individual NFT. Therefore, from a technical perspective, an NFT is essentially a piece of code on the blockchain distinguished by both its address and a specific number that sets it apart from other tokens within the collection. In addition, most platforms allow creators

to set a fee up to 10%, which is earned every time one of their NFTs is sold. In the picture can be found the details we would be given of a specific NFT if we were to check its details in a platform like OpenSea, for example (see Figure 13).

*Figure 13. Random NFT details*

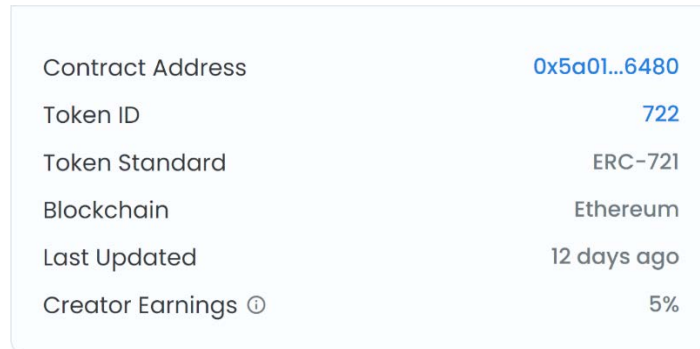

Contract Address	0x5a01...6480
Token ID	722
Token Standard	ERC-721
Blockchain	Ethereum
Last Updated	12 days ago
Creator Earnings ⓘ	5%

Source: OpenSea (2023)

On the other hand, the blockchain is not suitable for extensive file storage due to its finite capacity and associated costs. This is because it is an open and shared database that requires clear limitations to prevent abuse and the exponential growth of data. However, the blockchain excels in storing valuable and compact information, such as transaction details, where the data size is significantly smaller compared to multimedia files. Consequently, it is more efficient to leverage the blockchain for storing transactions or text-based information, rather than bulky media files, allowing for optimal use of the available resources. Therefore, images or documents cannot be stored in the blockchain since it would be extremely inefficient. However, files can be stored in external storage systems are either centralized or decentralized.

- **Centralized Servers:** The first option is to store the images on a traditional server. The user or creator of the NFT purchases or rents a server and stores the images there. Similar to accessing a webpage through its server address, the images can be located using the server address where they are stored. This is a simple and efficient solution but comes with a clear drawback. Since the server is always controlled by a person or entity, the images could be modified or deleted at any time. Generally, this practice is not well-regarded in the Web 3.0 ecosystem as it goes against the principles of decentralization and transparency. However, there are cases where certain NFTs, whose metadata (visual appearance, attributes, etc.) lack significance and value, can be managed in this way.

- **Decentralized Storage:** The more common option is to utilize decentralized storage networks like IPFS or specialized blockchains. This allows files and data uploaded to the network to be stored permanently without the control of a single entity, emulating the principles of blockchain operation. This alternative is preferred by the vast majority since an NFT created using this technique is truly decentralized and cannot be altered by anyone from any perspective. This is of utmost importance when dealing with digital art but also when an NFT is linked to a signed contract or a property ownership certificate. To link files to an NFT, a unique address called a URI (Uniform Resource Identifier) is assigned to each token ID within the smart contract as it is depicted in Figure 14.

Figure 14. Decentralized storage in Ethereum

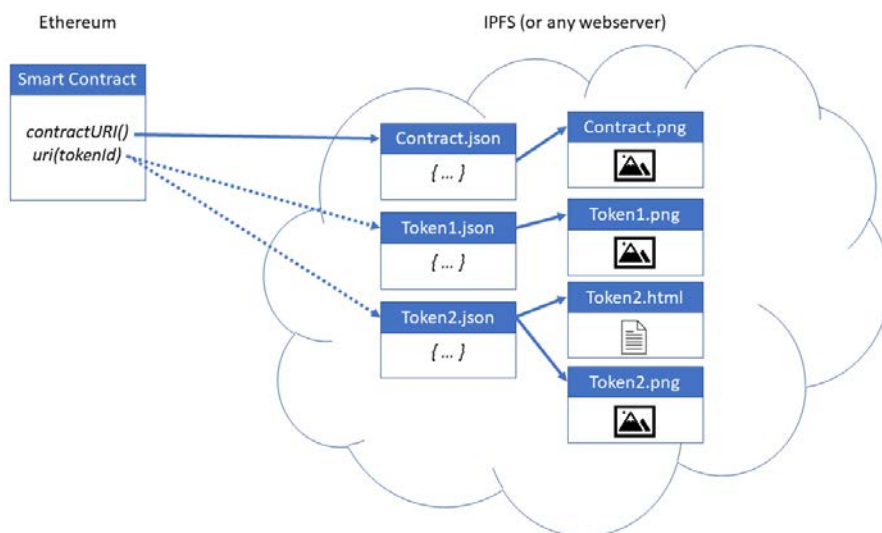

Source: Hellwig (2022) [59]

Like it has been explained so far, metadata encompasses all types and formats of information associated with an NFT. This includes images, documents, attributes, and more. Platforms like OpenSea display essential metadata such as image, name, description, and properties for each NFT. While this information may appear less significant in profile picture collections generated by algorithms, these properties can determine the validity, usage, expiration, or unique advantages of an NFT within a collection. In fact, the metadata, existing outside the blockchain, plays a crucial role by establishing scarcity and creating a connection between the blockchain and other digital or physical assets.

On the other hand, NFT marketplaces serve as user interfaces that interact with smart contracts, enabling the transfer of ownership between buyers and sellers. When a purchase is made, the marketplace instructs the smart contract to transfer token ownership, provided that the buyer meets the specified price. While marketplaces require sophistication for a seamless user experience, their core functionality lies in connecting with smart contracts and facilitating token trading. These whole process of trading NFTs through a smart contract is depicted in Figure 15.

Figure 15. Functioning of smart contracts

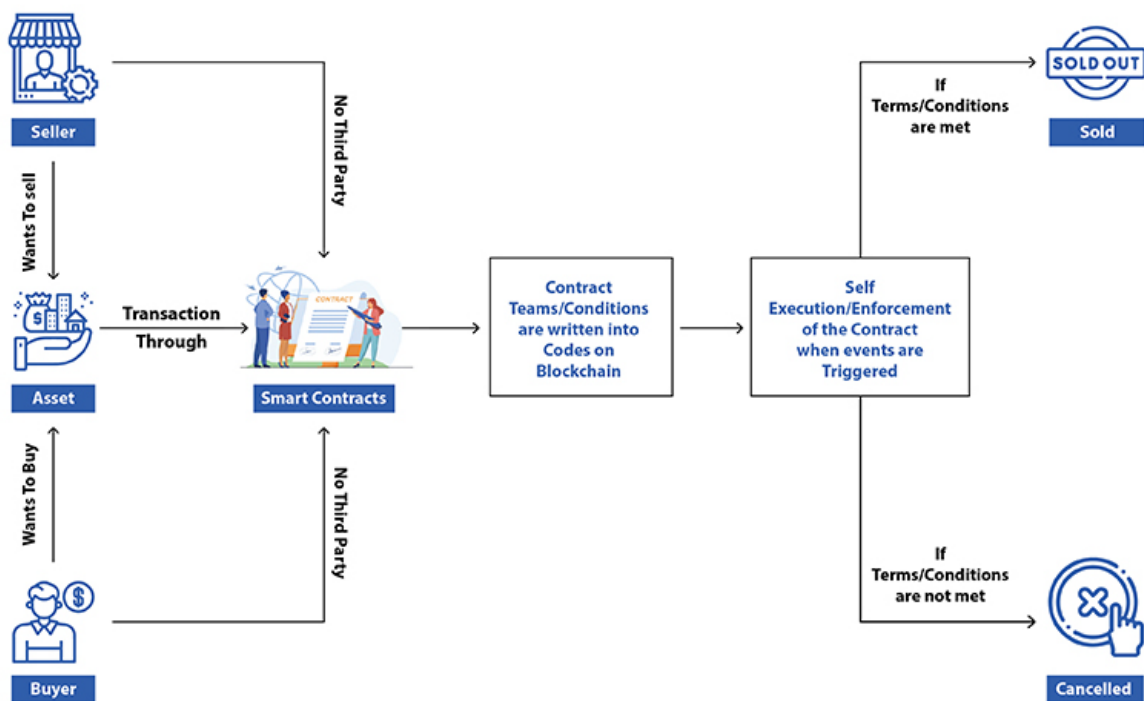

Source: Fabiana (2023) [48]

#### 4.2.2 Additional functionalities for managing patents

As discussed in the previous section, ERC-721 is a widely used standard in the blockchain space for creating and managing non-fungible tokens (NFTs). In this section, we will explore how the functionalities of ERC-721 have been extended and applied to the specific use case of managing patents as NFTs, providing an overview of the key features and functionalities of the implemented contract.

The code given under “PatenteNFT.sol” in Annex I represents a smart contract called "PatenteNFT" that serves as a system for managing patents as non-fungible tokens (NFTs) on the Ethereum blockchain (see Figure 16 and Figure 17 ). The contract is built using the Solidity programming language and follows the ERC721 standard, which is a widely adopted standard for NFTs. To ensure code reusability and security, the contract imports various libraries from the OpenZeppelin project. These libraries include ERC721Enumerable for NFT enumeration, Ownable for contract ownership functionality, and Strings for convenient string operations.

The contract consists of several key components, including events, data structures, and mappings. Events such as "NewPatentIssued," "NewAuthority," and "PatentSold" are defined to emit relevant information about the contract's state and activities. These events enable external systems to listen and respond to specific occurrences within the contract.

To store and manage patent-related data, the contract defines a structure called "Patent." This structure holds information such as the patent's title, patent number, timestamp of issuance, status (active or expired), inventor's address, royalties' percentage, issuer's address, sale price, active period, and total registration fees paid. Additionally, the contract defines structures for registration fees and fee payment status, facilitating the management of paid fees for each address.

The contract employs several mappings to associate patent data with token IDs, track fee payment status for addresses, and store the total fees paid by addresses. These mappings enable efficient retrieval and updating of relevant information when interacting with the contract. During contract deployment, the constructor function initializes various contract parameters. These include setting the contract's base URI for storing token metadata, defining the initial registration fees, and designating the contract owner as an authorized entity.

The contract also includes modifier functions that restrict access to certain functions based on conditions. For instance, the "onlyPaid" modifier ensures that an address has paid the required registration fees before invoking specific functions, while the "isAuthority" modifier verifies that the caller is an authorized entity. These modifiers enhance the contract's security and maintain proper control over contract operations.



It also provides several getter functions to allow external systems to retrieve information from the contract, like registration fees, obtaining patent data for a specific token ID, and checking fee payment status for a given address.

Additionally, the contract features setter functions that enable the contract owner to manage the contract's authorities, registration fees, and the base URI for token metadata. The "setAuthority" function adds a new authorized entity, "revokeAuthority" removes an authorized entity, "updateRegistrationFees" modifies the registration fees, and "updateBaseURI" changes the base URI for token metadata storage.

To issue a new patent, the contract includes an "issuePatent" function that can only be invoked by authorized entities. This function requires that the inventor (beneficiary) has paid the required registration fees and mints a new token (NFT) for the inventor, assigning it a unique token ID. The function also sets the corresponding patent data based on the provided parameters, while clearing the inventor's fee payment status for future registrations.

To facilitate the payment of registration fees, the contract provides a "payRegistrationFees" function that allows users to pay the fees associated with patent registration. This function verifies the transaction value against the required fee, ensures the caller has paid the previous fees, and updates the fee payment status and the total fees paid by the caller accordingly.

Moreover, the contract allows patent owners to set royalties for their patents using the "setRoyalties" function. Only the inventor and the current owner of a patent can invoke this function, which verifies the ownership, the inventorship, and the validity of the royalties' value before updating the patent's royalties' percentage. Furthermore, the contract enables patent owners to set a sale price for their patents using the "setSalePrice" function. This function verifies that the patent is still active, and that the caller is the current owner of the patent before updating the sale price.

Figure 16. Contract initialization

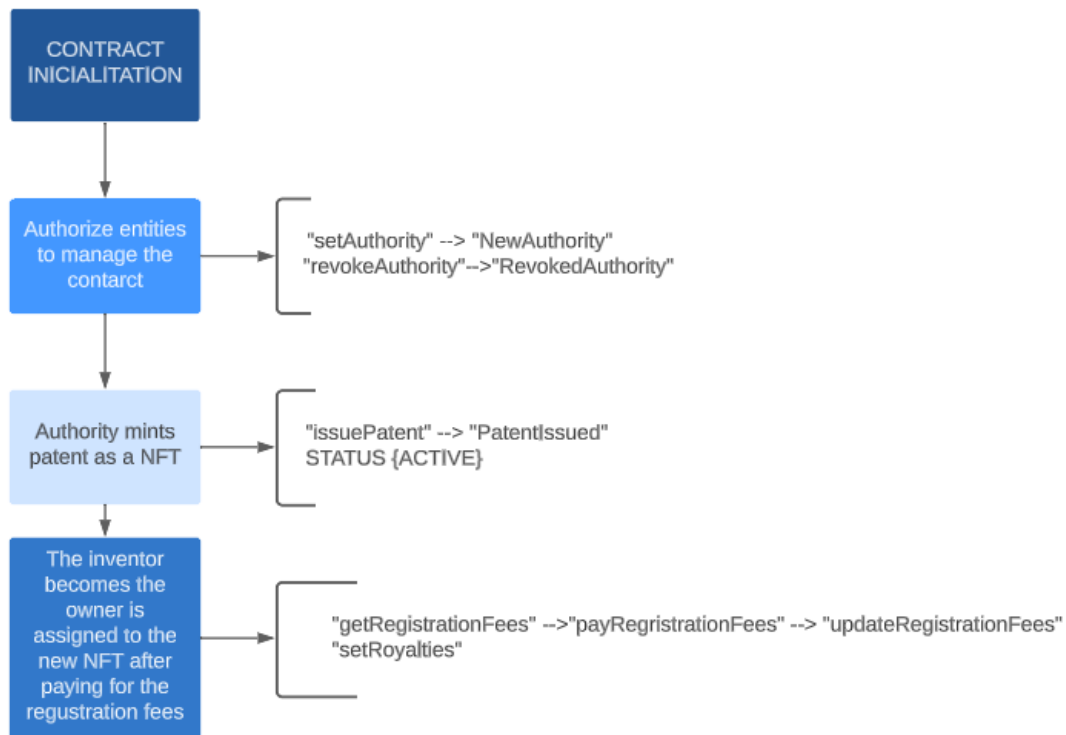

Source: own elaboration

To facilitate the purchase of patents, the contract includes a "buyPatent" function that allows users to buy a patent by paying the specified sale price. This function ensures that the patent is active, available for sale, and that the transaction value matches the sale price. Upon a successful purchase, the contract transfers ownership of the patent to the buyer, calculates and distributes royalties to the inventor and the seller, and handles the financial transactions accordingly. Once the transaction is signed the contract allows the contract owner to withdraw funds from the contract by means of the "withdrawFunds" function. Only the contract owner can invoke this function, which transfers the contract's balance to the new owner's address.

Additionally, internally, the contract includes functions to check if a patent is still active and update its status if it has expired. The "\_isNotExpired" function verifies the patent's expiration status based on the active period defined during patent issuance. If the patent is expired, its status is updated accordingly. Additionally, the contract includes an internal function called "\_calculateRoyalties" to determine the royalties amount to be paid to the inventor and the seller based on the sale price and the royalties' percentage defined for a patent.

Figure 17. Sale of a patent

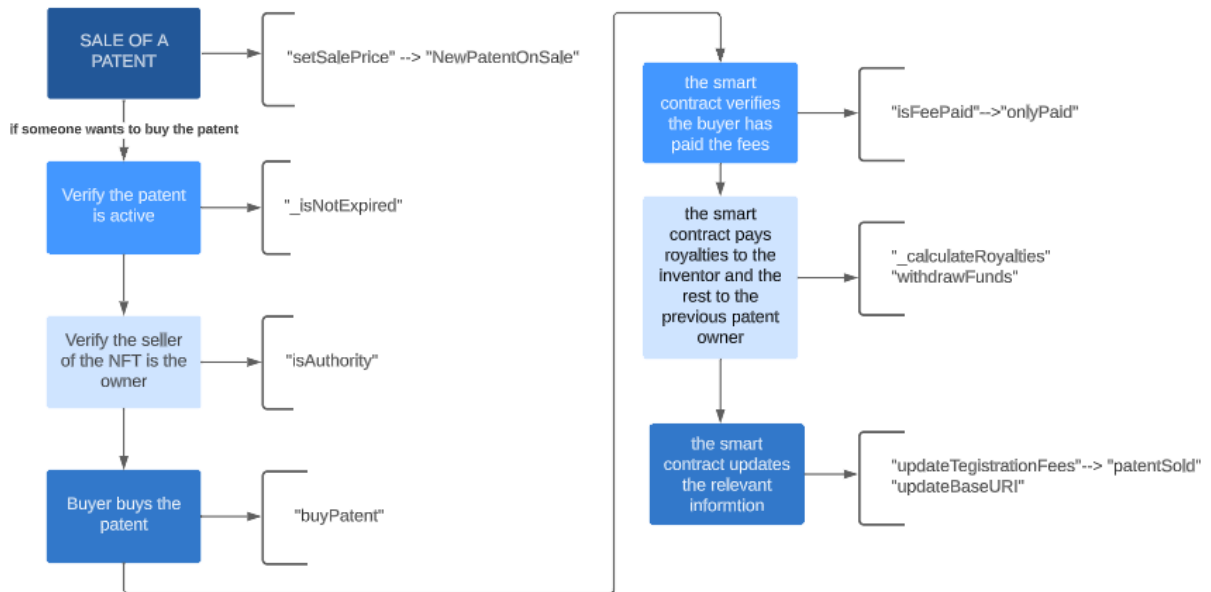

Source: own elaboration

The recompilation of all these functions, together with their description can be found in the table below (see Table 1):

Table 1. Summary of the functionalities for managing patents

Action	Name	Purpose
<b>Events</b>		
Event	NewPatentIssued(uint256 indexed tokenId, uint256 timestamp, address inventor)	Emitted when a new patent is issued, providing information about the patent, including its token ID, issuance timestamp, and inventor's address.
Event	NewAuthority(address authority)	Emitted when a new authorized entity is added to the contract, logging the address of the newly added authority.
Event	RevokedAuthority(address authority)	Emitted when an authorized entity's status is revoked, logging the address of the revoked authority.

Event	RegistrationFeePayment(address indexed payer, uint8 feeId)	Emitted when a registration fee is paid, logging the address of the payer and the fee ID that was paid.
Event	NewPatentOnSale(uint256 indexed tokenId, uint256 salePrice)	Emitted when a patent is put up for sale, logging the token ID of the patent and the sale price.
Event	PatentSold(uint256 indexed tokenId, address buyer, address seller, uint256 price)	Emitted when a patent is sold, logging the token ID of the sold patent, the buyer's address, the seller's address, and the sale price.

---

### Enum

Enum	STATUS {ACTIVE, EXPIRED}	Defines the possible status values for a patent, indicating whether it is active or expired.
------	--------------------------	--

---

### Structs

Struct	Patent	Represents the data structure for a patent, containing the patent's title, patent number, issuance timestamp, status, inventor's address, royalties' percentage, issuer's address, sale price, active period, and total registration fees paid.
Struct	RegistrationFees	Holds the registration fees for different fee IDs.
Struct	FeePayment	Tracks the payment status of registration fees for an address.

---

### Mappings

Mapping	mapping(uint256 => Patent) private _patentData	Maps a token ID to the patent data associated with that token ID.
Mapping	mapping(address => FeePayment) private _feesPaid	Maps an address to the payment status of registration fees for that address.

Mapping	mapping(address => uint256) private _totalFeesByAddress	Maps an address to the total registration fees paid by that address.
Mapping	mapping(address => bool) private _authorities	Maps an address to a boolean value indicating whether the address is an authorized entity.

---

**Constructor**

Constructor	constructor(string memory <i>name</i> , string memory <i>symbol</i> , string memory <i>baseURI</i> )	Initializes the contract by setting the contract name, symbol, base URI for token metadata, assigning initial registration fees, and designating the contract owner as an authorized entity.
-------------	--	--

---

**Modifiers**

Modifier	modifier onlyPaid(address candidate)	Checks if an address has paid the registration fees. Reverts if the candidate address has not paid all the required fees.
Modifier	modifier isAuthority(address candidate)	Checks if an address is an authorized entity. Reverts if the candidate address is not an authorized entity.

---

**Getter Functions**

Function	function getRegistrationFees() public view returns(RegistrationFees memory)	Retrieves the registration fees stored in the contract, returning a RegistrationFees struct containing the fee values.
Function	function getPatentById(uint256 tokenId) public view returns(Patent memory)	Retrieves the patent data associated with a given token ID, returning a Patent struct containing the patent information.

Function	function isFeePaid(address addr) public view returns(FeePayment memory)	Checks if an address has paid the registration fees, returning a FeePayment struct indicating the payment status.
Function	function tokenURI(uint256 tokenId) public view override returns(string memory)	Constructs and returns the URI for a given token ID, appending the token ID to the base URI for metadata storage.
Function	function _baseURI() internal view override returns(string memory)	Returns the base URI for token metadata storage.

---

**Setter Functions**

Function	function setAuthority(address newAuthority) public onlyOwner	Sets a new authorized entity. Only the contract owner can invoke this function.
Function	function revokeAuthority(address revokedAuthority) public onlyOwner	Revokes the authority of an authorized entity. Only the contract owner can invoke this function.
Function	function updateRegistrationFees(uint256 _fee1, uint256 _fee2, uint256 _fee3) public onlyOwner	Updates the registration fees. Only the contract owner can invoke this function.
Function	function updateBaseURI(string memory newBaseURI) public onlyOwner	Updates the base URI for token metadata storage. Only the contract owner can invoke this function.

---

---

### Patent Issuance Function

Function	function issuePatent(string memory _title, address _inventor, uint256 _activePeriod) public onlyPaid(_inventor) isAuthority(_msgSender())	Allows authorized entities to issue new patents, mints a new token for the inventor, assigns a unique token ID, and sets the patent data.
----------	--	---

---

### Fee Payment Function

Function	function payRegistrationFees(uint256 feeId) public payable	Allows users to pay the registration fees, verifying the transaction value, previous fee payment status, and updating the fee payment status and total fees paid.
----------	--	---

---

### Royalties and Sale Price Setting Functions

Function	function setRoyalties(uint256 tokenId, uint256 _royalties) public	Allows patent owners to set royalties for their patents, verifying the caller's identity and updating the royalties percentage.
Function	function setSalePrice(uint256 priceSale, uint256 tokenId) public	Allows patent owners to set a sale price for their patents, verifying the patent's status and the caller's ownership before updating the sale price.

---

### Patent Purchase Function

Function	function buyPatent(uint256 tokenId, address addrBuyer) public payable	Allows users to purchase a patent, verifying the patent's availability and transaction value, transferring ownership, calculating, and distributing royalties and proceeds accordingly.
----------	---	---

---

---

**Withdraw Funds Function**

Function	function withdrawFunds() public onlyOwner	Allows the contract owner to withdraw funds from the contract by transferring the contract's balance to the owner's address.
----------	--	--

---

**Internal Function**

Function	function _isNotExpired(uint256 tokenId) internal returns(bool)	Checks if a patent is still active, updates the patent's status, and returns a boolean indicating its active status.
Function	function _calculateRoyalties(uint256 tokenId, uint256 price) internal view returns(uint256, uint256)	Calculates the royalties amount to be paid to the inventor and the seller based on the sale price and royalties percentage. Returns the royalties amount and the amount to be paid to the seller.

---

Source: own elaboration

Once the main functionalities included in the smart contract have been defined, the following flow chart explains (see Figure 18) the series of steps to manage the issuance, registration, and sale of patents through which the contract operates.

First, during the contract initialization phase, the contract name, symbol, and base URI for token metadata are set. Additionally, the initial registration fees are assigned, and the contract owner is designated as an authorized entity. This establishes the foundation for patent management within the contract.

Once the contract is set up, authorized entities can issue patents. To issue a patent, an authorized entity calls the **issuePatent** function, providing the necessary information such as the patent's title, inventor's address, and active period. Before issuing the patent, the contract checks if the inventor has paid the registration fees. If the fees are paid, a new token (NFT) is minted, and a unique token ID is assigned.



The patent data, including its title, patent number, timestamp, status, inventor, royalties, issuer, sale price, active period, and total fees, is set accordingly. By clearing the fee payment status for the inventor, the contract enables them to register additional patents in the future. Moreover, users can pay the registration fees by calling the **payRegistrationFees** function. This function allows users to pay the specific registration fee required for patent registration.

Figure 18. Patent issuance, registration, and management through a smart contract

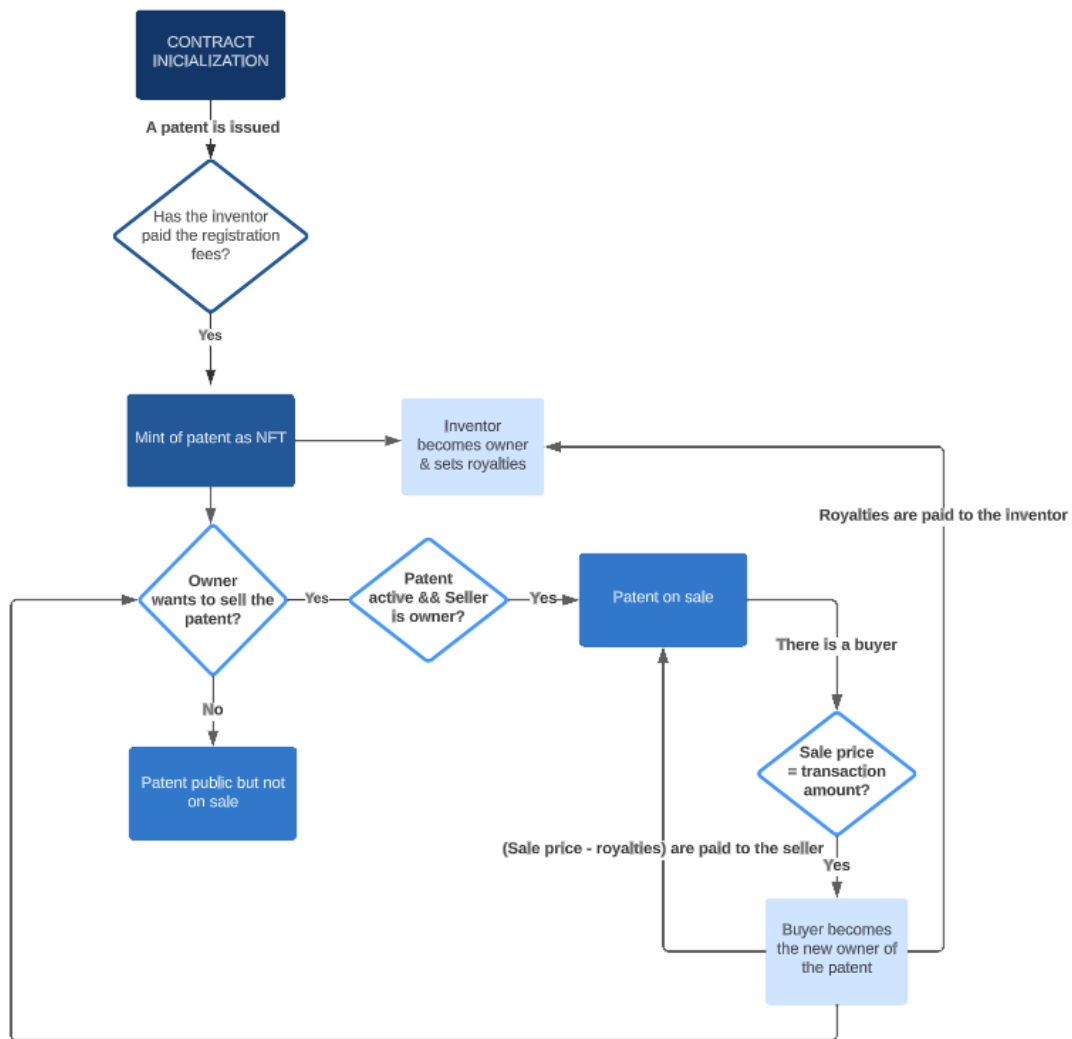

Source: own elaboration

It verifies the fee ID and the transaction value to ensure they match the required fee. Additionally, it checks the payment status for previous fees to prevent double payment. If the payment is valid, the fee payment status for the caller's address is updated, and the total fees paid by the caller are incremented.

Patent owners have the ability to set royalties for their patents using the **setRoyalties** function. This function verifies that the caller is both the inventor and the current owner of the patent. It also checks the validity of the royalties value, ensuring it falls within the range of 0 to 10,000. If the conditions are met, the royalties percentage for the patent is updated, allowing the inventor to receive a portion of the sale proceeds if the patent is sold in the future.

In addition to royalties, patent owners can set a sale price for their patents using the **setSalePrice** function. Similar to setting royalties, this function verifies the patent is active and that the caller is the current owner. If the conditions are met, the sale price for the patent is updated, indicating that the patent is available for sale at the specified price. Users can purchase patents by calling the **buyPatent** function. This function checks if the patent is active and available for sale. It also verifies if the transaction value matches the sale price specified by the patent owner. If the conditions are met, ownership of the patent is transferred to the buyer, and the appropriate funds are distributed. The function calculates and distributes royalties to the inventor and the seller based on the sale price, ensuring that the inventor receives the designated royalties, and the seller receives the remaining amount.

Finally, once the sale has been done, the contract owner has the ability to withdraw funds from the contract by calling the **withdrawFunds** function. This allows the contract owner to access the accumulated funds in the contract balance. By initiating this function, the contract owner can retrieve the funds that have been accumulated through patent sales and registration fees.

It is important to mention that while a smart contract operates autonomously on the blockchain, it is often necessary to have an application layer that facilitates interaction between inventors, sellers, and other participants. The smart contract, by its nature, enforces predefined rules and executes transactions based on predetermined conditions. However, an application layer can enhance the user experience by providing a user-friendly interface and facilitating the communication between all parties involved. Additionally, an application layer can provide additional functionalities such as search features, notifications, and analytics, making it easier for users to navigate and engage with the platform.

## **5. Economic Analysis. A practical case study**

It has already been seen how incorporating blockchain technology into the traditional patent system has the potential to revolutionize the way intellectual property is protected and managed. This chapter conducts an economic analysis of incorporating blockchain technology into the current Spanish patent system, first, from a patent office perspective, and then from a patent licensor perspective. In the first case, three different scenarios are compared to the base scenario, which corresponds to the traditional patent system (see Table 2), examining variables such as labor hours, increased efficiency, and storage costs in both centralized and decentralized systems. By evaluating the economic impact, this study aims to identify the most profitable and feasible option for the Spanish patent system, shedding light on the transformative potential of blockchain in enhancing efficiency, transparency, and overall effectiveness. In the second part of the economic analysis, an examination of how the price of a patent license could change was conducted, shedding light on the potential benefits that blockchain technology could bring to patent holders. The analysis provides valuable insights for decision-makers seeking to leverage blockchain technology within the Spanish patent system.

## 5.1 Patent office perspective

In this part of the economic analysis, the impact of incorporating the blockchain to the traditional patent system is studied according to the different scenarios provided in the following table (see ):

Table 2):

*Table 2. Description of scenarios*

<b>Base Scenario: traditional patent system</b>	<b>Scenario 1: revenue optimization scenario in a centralized storage system</b>
No Blockchain + centralized storage	Blockchain + centralized storage + no dismissals
<b>Scenario 2: labor cost reduction in a centralized storage system</b>	<b>Scenario 3: labor cost reduction in a decentralized storage system</b>
Blockchain + centralized storage + dismissals	Blockchain + decentralized storage + dismissals

### 5.1.1 Base scenario: traditional patent system

The base scenario corresponds to a five-year plan in which revenues and cost of the traditional patent system are analyzed. Like explained in previous chapters, for the sake of complexity, this study aimed to analyze only the Spanish national patent. However, during the research process, it was discovered that specific information regarding national patents was not readily available. Instead, data related to all the titles issued by the OEPM was found, including national patents, utility models, supplementary protection certificates, national industrial designs, national trademarks, and trade names. Therefore, data had to be processed to obtain relevant information.

First, the historical number of issued and active patents was checked (CAGR of -6,0% and -9,7% respectively considering the last five years) to predict the behavior of these variables in the future. Results can be found in the following table (see Table 3) where data until 2022 is real data and the remaining are predictions:

*Table 3. Issued and active patents per year*

	2021	2022	2023	2024	2025	2026	2027
# Issued patents	1.361	1.231	1.157	1.087	1.022	960	902

# Active	20.707	18.705		16.897	15.263	13.787	12.454	11.250
----------	--------	--------	--	--------	--------	--------	--------	--------

Moving on to financial results, performance regarding the Spanish patent office (OEPM) was not updated (latest data from 2018), and therefore, the latest financial figures had to be predicted, mainly income (both from issuing and maintenance of titles) and labor costs. The reason behind only taking these two variables is that they are the ones would change most with the implementation of the blockchain to the traditional patent system. On the one hand, since income from titles is directly related to their number, the sum of the CAGR relative to the number of active patents, together with the latest inflation rate was used as the growth rate. This inflation rate had a value of 1,9% to date June 2023 [62] and was also used in the rest of the calculations given it is the most up-to-date piece of data. On the other hand, since the OEPM is a public institution and government employees cannot be dismissed so easily, the inflation rate was used in the prediction, but it was assumed that salaries were not adjusted to the decreasing number of titles managed by the OEPM.

$$(1) \text{ Income}_{2022} = \text{Income}_{2018} * (1 + \text{Inflation} - \text{CAGR}_{\text{active patents}}) = 58.219.410 \text{ €} * (1 + 1,9\% - 9,7\%) = 42.129.540 \text{ €}$$

$$(2) \text{ Labor costs}_{2022} = \text{Labor costs}_{2018} * (1 + \text{Inflation}) = 20.624.784 \text{ €} * (1 + 1,9\%) = 22.237.509 \text{ €}$$

Once the income for the latest year was calculated, earnings were distributed according to the fees paid when issuing each type of title [72]. In addition, it was considered the proportion of applications done digitally as opposed to those done in paper, since online applications had a 15% discount. For the sale of simplicity, maintenance fees were considered proportional to the issuing fees and were calculated subtracting the issuing fees from the total fees assigned to each type of title. Results are shown in the following table (see Table 4).

Once the total income for maintaining patents in 2022 was known (7.001.322 €), it was divided by the number of active patents to estimate the average annual maintenance fee, resulting in 374€

Table 4. OEPM Income distribution by titles

	# patents 2022	Original fee (€)	Adjusted fee online/ paper (€)	Income from issuing (€)	% of income from Is.	Income from maintenance (€)
National Patents	1231	120	1034	1.273.346	20%	7.001.322
Utility Models	2596	100	87	226.112	3%	1.243.244
Supplementary Protection Certificates	63	100	85	5.355	0%	29.444
National Industrial Design	1194	75	64	76.252	1%	419.260
National Trademarks	45227	100	85	3.844.295	59%	21.137.332
Trade Names	12444	100	85	1.057.740	16%	5.815.839
Total income (€)				6.483.100		35.646.440

For the distribution of labor hours, the average time estimated for issuing each title was used. Then, the allocation of time was done considering the number of active titles in each category. While it takes on average nine months to issue national industrial designs, national trademarks, and trade names, utility models take a year and a half. On the other hand, national patents usually take between two and four years until they are issued, and supplementary protection certificates take two years on average.

Based on this information, it was calculated that government employees in the OEPM spend almost two thirds of their time working on national trademarks, and only 7,1% of it on patents. This allocation of time was used to divide the labor costs, resulting in 1.108.450,54€ spent on patents in 2022.

Later, it was estimated that workers spent around 70% of their time on tasks prior to issuing the patent, this is in the reception and classification of applications, substantive examination, and administrative procedures, and the remaining 30% in tasks done once the patent is issued. These tasks include the publication of the patent and the patent maintenance with refers to the ongoing procedures and periodic fees that must be handled for the maintenance of the patent throughout its validity period. With this information, the labor costs related to each of the two main stages of the life of a patent were assigned, and subsequently, this information was then used to predict the labor costs that were included in the profit projection.

$$(3) \text{ Labor cost s\textsubscript{issuing} (2022)} = -1.108.451\text{€}$$

$$(4) \text{ Labor cost s\textsubscript{maintenance} 2022} = -475.050 \text{ €}$$

Once the main variables were identified, the profit projection was done. Like explained before, revenues were calculated multiplying the number of patents by the fee, both for issued and already active patents. On the other hand, since it was assumed no one was dismissed, labor costs from one year to another were calculated each year by applying an inflation rate of 1,9%.

*Table 5. Profit projection Base scenario*

	2022	2023	2024	2025	2026	2027
# Issued patents	1231	1157	1087	1022	960	902
# Active patents	18705	16897	15263	13787	12454	11250
Rev. from issued patents	1.273.346	1.196.801	1.124.393	1.057.157	993.024	933.029
Rev. from patent maintenance	7.001.321	6.324.583	5.712.974	5.160.504	4.661.559	4.210.899
Total rev. from patents	8.274.668	7.521.384	6.837.366	6.217.660	5.654.583	5.143.928
Labor cost for patent issuance	1.108.451	1.129.511	1.150.972	1.172.840	1.195.124	1.217.832
Labor cost for patent maintenance	475.050	484.076	493.274	502.646	512.196	521.928
Total labor cost	1.583.501	1.613.587	1.644.245	1.675.486	1.707.320	1.739.759
Net profit	6.691.167	5.907.797	5.193.121	4.542.174	3.947.262	3.404.168

### **5.1.2 Scenario 1: revenue optimization scenario in a centralized storage system**

In this scenario, the introduction of blockchain technology is specifically targeted at the maintenance phase of a patent's lifecycle, this is, from the moment it is issued until its expiration. As explained in the previous chapter, the implementation of smart contracts enables the automatic execution of various actions associated with a patent, such as earning royalties, conducting sales and purchases, and facilitating owner changes. Consequently, individuals who were previously responsible for these tasks within the traditional system are now liberated to concentrate on the pre-issuance actions. This strategic reallocation of resources allows for a more efficient utilization of human capital within the system, maximizing their expertise and experience in activities such as reviewing applications, conducting in-depth examinations, and ensuring compliance with formal requirements. Given our assumption that 30% of the workforce was involved in maintenance work, we can expect a corresponding 30% increase in productivity. This surge in productivity leads to a proportional increase in revenues (see Table 6), as resources are reallocated to more value-added activities.

However, it is important to acknowledge that there are transaction costs associated with the utilization of blockchain, commonly referred to as gas fees. These fees are incurred for executing actions and transactions on the blockchain network and follow the following equation:

$$(5) \text{ Transaction Cost in EUR} = \text{Gas Limit gas unit} \times \text{Gas Price gwei} \times 10^{-9} \text{ ETH/gwei} \times \text{Exchange rate (EUR/ETH)}$$

- The **gas limit** in Ethereum refers to the maximum amount of gas that can be consumed by a block in the Ethereum blockchain. A standard everyday ETH transfer or NFT mint requires a gas limit of 21,000 units of gas. On the other hand, an ERC-721 NFT transfer would be 85.000 units of gas, and a sale in OpenSea (the largest NFT marketplace) would be 205.000 gas units.
- The **gas price** in Ethereum represents the Ether (ETH) value that users are ready to spend for each unit of gas utilized during transactions or smart contract executions within the Ethereum network. This price is measured in Gwei, which serves as a fractional unit of ETH (1/10<sup>9</sup>). The average gas price to date July 19<sup>th</sup> is 35,38 gwei.
- The **exchange rate** between EUR (Euro) and ETH (Ethereum) can fluctuate and is determined by market dynamics on cryptocurrency exchanges. The value to date July 19<sup>th</sup> was 1696,08 EUR/ETH.

For the sake of the analysis, it was assumed that a regular NFT patent would be minted (in Solidity, minting equals transferring an NFT from the null address to an existing one) and sold at least once in 20 years. With this in mind, the Blockchain cost for the patent maintenance would be 17,4€ being this figure the sum of the following two transactions (see Table 6):

$$(6) \text{ Transaction cost ERC - 721 NFT transfer} = 85.000 \text{ gas} * 35,38 \text{ gwei} * 10^{-9} \text{ ETH/gwei} * 1696 \text{ EUR/ETH} = 5,10 \text{ EUR}$$

$$(7) \text{ Transaction cost sale} = 205.000 \text{ gas} * 35,38 \text{ gwei} * 10^{-9} \text{ ETH/gwei} * 1696 \text{ EUR/ETH} = 12,30 \text{ EUR}$$

Although these costs might not seem too high, it is important to mention that gas prices vary depending on supply and demand, therefore, these values do not reflect the average



cost, but a local data point. For example, the highest value of gas in the last three years took place on September 17<sup>th</sup>, 2020 with an average value of 538 Gwei. This means that if we were to create an NFT and sell it that day, we would have paid 265€ on transaction fees.

This example portrays the idea that the Ethereum network is very efficient in most of the cases, although there are some unpredictable moments in which costs are that high that doing transactions with tokens in the network becomes unmanageable like it has happened in certain moments. Below (see Figure 19 ) there is a chart showing the gas fees registered in the last three years.

Figure 19. Ethereum average gas price (3Y)

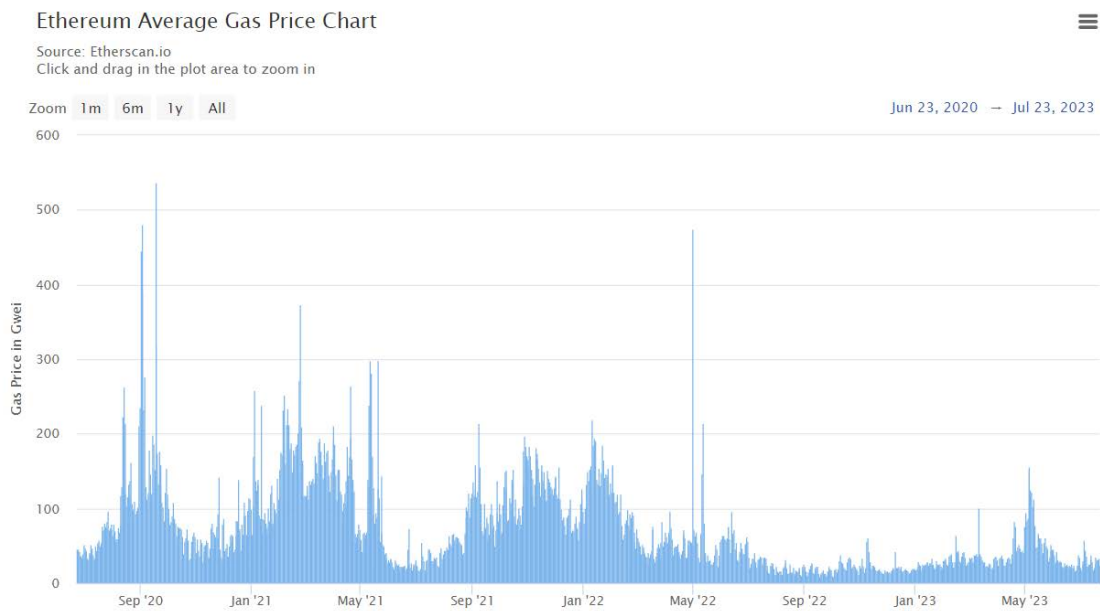

Source: Etherscan.io (2023) [45]

However, for the sake of the analysis, current data will be considered, which means data collected on July 19<sup>th</sup>, 2023, like shown in the following table (see Table 6):

Table 6. Profit projection Scenario 1

	2022	2023	2024	2025	2026	2027
# Issued patents	1.231	1.157	1.087	1.022	960	902
# Active patents	18.705	16.897	15.263	13.787	12.454	11.250

Revenue from issued patents	1.655.350	1.555.841	1.461.711	1.374.304	1.290.931	1.212.937
Revenue from patent maintenance	7.001.321	6.324.583	5.712.974	5.160.504	4.661.559	4.210.899
Total revenue from patents	8.656.672	7.880.424	7.174.684	6.534.807	5.952.490	5.423.836
Labor cost for patent issuance	1.583.501	1.613.587	1.644.245	1.675.486	1.707.320	1.739.759
Blockchain cost for patent maintenance	17	17	17	17	17	17
Total cost	1.583.518	1.613.605	1.644.263	1.675.503	1.707.338	1.739.777
Net profit	7.073.154	6.266.820	5.530.421	4.859.304	4.245.152	3.684.060

While the implementation of blockchain enables decentralized storage options, in this particular scenario, it is assumed that the traditional approach of centralized storage on local servers will persist. This assumption reflects the current infrastructure and practices in place. Nonetheless, the benefits of blockchain technology, such as automated execution, enhanced security, and increased transparency, still prevail despite the transaction costs and the utilization of traditional centralized storage methods.

### 5.1.3 Scenario 2: labor cost reduction in a centralized storage system

In this scenario, a new option is being evaluated, which involves considering the dismissal or reassignment of workers who would be "replaced" by the implementation of blockchain technology. Therefore, the labor cost associated with the maintenance of patents (475.050€ in 2022) is eliminated with the corresponding increase in transaction costs in the blockchain network (calculated in section 4.2). Although this option poses clear social consequences and is not the optimal choice, it is essential to acknowledge that the introduction of blockchain brings forth a new paradigm. With this paradigm shift, certain job roles may become obsolete, leading to a potential reduction in the workforce of organizations such as the OEPM. Moreover, a centralized storage system will also be assumed in this scenario since it is the easiest solution considering the operations of the traditional patent system (see Table 7):

Table 7. Profit projection Scenario 2

	2022	2023	2024	2025	2026	2027
# Issued patents	1.231	1.157	1.087	1.022	960	902
# Active patents	18.705	16.897	15.263	13.787	12.454	11.250

Revenue from issued patents	1.273.346	1.196.801	1.124.393	1.057.157	993.024	933.029
Revenue from patent maintenance	7.001.321	6.324.583	5.712.974	5.160.504	4.661.559	4.210.899
Total revenue from patents	8.274.668	7.521.384	6.837.366	6.217.660	5.654.583	5.143.928
Labor cost for patent issuance	1.108.451	1.129.511	1.150.972	1.172.840	1.195.124	1.217.832
Blockchain cost for patent maintenance	17	17	17	17	17	17
Total cost	1.108.468	1.129.528	1.150.989	1.172.858	1.195.142	1.217.849
Net profit	7.166.200	6.391.856	5.686.377	5.044.803	4.459.441	3.926.079

**5.1.4 Scenario 3: labor cost reduction in a decentralized storage system**

Building upon the previous scenario, the current scenario assumed the absence of labor costs associated with patent maintenance due to blockchain implementation, as well as the existence of transaction costs inherent to blockchain technology. However, a notable distinction arises in this scenario regarding data storage. Unlike the previous scenarios where data was assumed to be stored in centralized servers, this scenario leverages blockchain's decentralized storage capabilities. As a result, the costs incurred in paying for storage to third-party providers are now eliminated. This is because data would be stored in the form of metadata in IPFS, where there are typically no direct costs incurred for storing the data itself. IPFS is a decentralized peer-to-peer network that utilizes a distributed hash table to store and retrieve content.

To estimate the cost of centralized storage services utilized by the OEPM, a comparison was made among the three prominent cloud solution providers: AWS, Microsoft Azure, and Google Cloud. Among these options, AWS was selected as the benchmark due to its significant market share, accounting for approximately 33% of the market [60]. Within the existing centralized storage infrastructure, an annual fee of 400€ was identified for unlimited storage. This fee represents the potential cost reduction that the OEPM could achieve by transitioning their storage to the blockchain. This cost reduction is included under blockchain related maintenance cost as a positive value in the profit projection below (see Table 8).

*Table 8. Profit projection Scenario 3*

	2022	2023	2024	2025	2026	2027
# Issued patents	1.231	1.157	1.087	1.022	960	902
# Active patents	18.705	16.897	15.263	13.787	12.454	11.250

Revenue from issued patents	1.273.346	1.196.801	1.124.393	1.057.157	993.024	933.029
Revenue from patent maintenance	7.001.321	6.324.583	5.712.974	5.160.504	4.661.559	4.210.899
Total revenue from patents	8.274.668	7.521.384	6.837.366	6.217.660	5.654.583	5.143.928
Labor cost for patent issuance	1.108.451	1.129.511	1.150.972	1.172.840	1.195.124	1.217.832
Blockchain cost for patent maintenance	-383	-383	-383	-383	-383	-383
Total cost	1.108.068	1.129.128	1.150.589	1.172.458	1.194.742	1.217.449
Net profit	7.166.600	6.392.256	5.686.777	5.045.203	4.459.841	3.926.479

### 5.1.5 Summary and comparison of the four scenarios

In this section, we will compare the three scenarios previously discussed with the base case of the traditional patent system. Each scenario brings its own set of benefits and drawbacks, ranging from technical considerations such as complexity, scalability, and security. However, our primary focus will be on evaluating the economic impact of these four cases. Through this analysis, we strive to provide valuable insights into the economic feasibility and desirability of incorporating blockchain technology into the Spanish patent system, enabling decision-makers to make informed choices for the future.

In the following figure (see Figure 20), the profit projection for the following five years can be seen. Please note that differences between Scenarios 2 and 3 are almost indistinguishable due to their similar values.

However, to be able to compare four scenarios, the net present value of the cash flows in the five-year projection was obtained, applying a discount rate of 1,9% as is shown below (see Table 9).

Figure 20. Profit projection 2021-2027

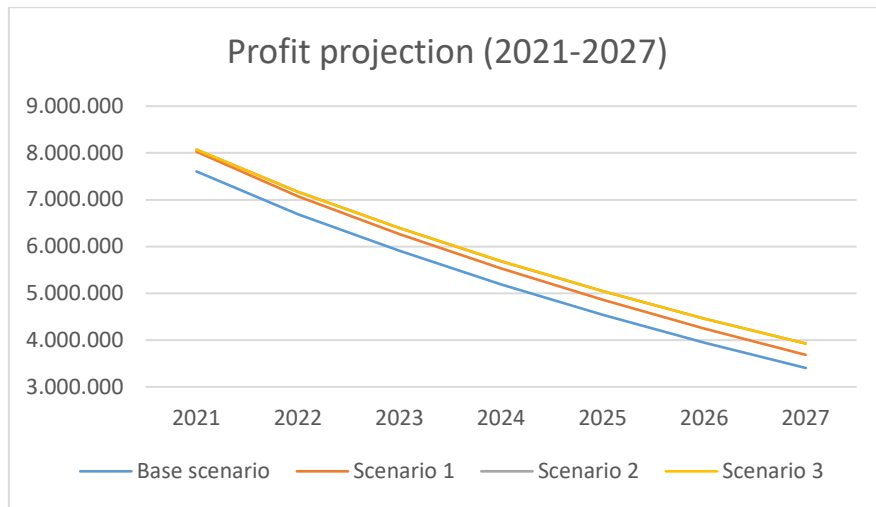

Table 9. NPV of profits in the different scenarios

i=1,9%	NPV (€)
Base scenario	21.851.129
Scenario 1	23.359.055
Scenario 2	24.226.298
Scenario 3	24.228.189

As it can be understood from the table above, the largest economic impact would take place under the Scenario 3 (2,4M€), which corresponds to the scenario in which the blockchain is incorporated to the traditional patent system, the workforce is reduced (eleven people out of 498 would be dismissed considering an average annual salary of 44.654€), and decentralized storage is used.

However, as it seems obvious, this option is the one with worse consequences for the workforce, which would lead to discontent within the organization. In addition, transitioning completely to the blockchain implies additional training for employees which would probably make the OEPM incur in additional costs that have not been considered. Finally, although decentralized storage increases security, scalability and traceability, no changes can be done once a piece of metadata has been uploaded to the decentralized network, which might have been a problem taking about patents.

## **5.2 Patent licensor perspective**

According to [110], firms seeking to profit from their inventions often rely on licensing as a vital strategy, particularly when they face limited resources for commercialization, and for companies, licensing becomes crucial when they aim to commercialize inventions that fall outside their core business. However, on average, only 40% of the rent from licensed technology is captured by a licensor based [32].

Regarding the price of patent licensing, it is determined by three key factors: the profitability of underlying patents, the reservation price set by licensors, and the relative bargaining power between licensors and licensees [110]. Since there is no public market for patents, the price is determined through private negotiation between the parties involved. The maximum price a licensor can potentially charge is the expected net present value of the patent for the licensee, while the minimum price the licensor can accept includes the transfer costs of licensed technology and opportunity costs of licensing [36]. The actual price of the patent will fall between these two extremes. In a perfect market for patents, the price would reflect the patent's expected net present value. However, the market is imperfect due to limited qualified potential licensors and licensees, asymmetric information on technological knowledge, uncertain economic performance of technology, and various transaction costs associated with licensing. Under such conditions, licensors and licensees cannot precisely estimate the true economic value of patents, and licensing deals are reached when the licensor underestimates the value, and the potential licensee faces no effective competitors. In such deals is where the firms' size, and consequently, the relative bargaining power between parties comes into play.

First, firm size plays a significant role in determining patent licensing price, as larger licensors tend to offer lower prices for patents, and this holds true for licenses as well. In this cases, small or lower quality inventions tend to be licensed, whereas major inventions, which afford the inventor an effective monopoly, are less likely to be licensed [68][108]. This is because firms with the ability to enjoy a monopoly by excluding competitors will usually choose to do so. This adverse selection effect is expected to be more pronounced for large firms since they have more alternative ways to generate and utilize their technological portfolio than smaller firms [65]. Large firms are also less motivated to license their technology because a larger market share of the licensor leads to higher losses in profits due to the creation of new competitors through licensing [7].

The size of a licensor or licensee can also affect their bargaining power. In the case of a licensor, bargaining power is determined by the ease of alternatives to licensing, such as commercializing the technology on their own. Large firms are likely to possess complementary assets that allow them to successfully commercialize their innovations [122], or they can acquire complementary assets more easily and cheaply due to their access to financial markets [51]. The same reasoning applies to licensees, where large firms have an advantage in developing necessary R&D capabilities compared to small firms due to their better access to capital. Additionally, if a licensor specializes in innovation, such as a university or government, it might accept a lower price than a licensor with capabilities to commercialize the technology, as it has no alternative but to sell the technology [110]. In addition, licensing prices are generally lower when the licensor is a research organization. In fact, the value of a patent licensed by a research organization as the licensor is 82% to 91% of the value of patents licensed by other types of licensors [110].

The concept of appropriability also plays a role in patent profitability. A patent is more profitable in an industry with strong patent protection, as competition from imitators is reduced [122]. Additionally, broader patents, supported by the courts, make the underlying innovation more profitable since derivative products are likely to infringe on the prior patent, discouraging the commercialization of close substitutes [113]. A licensor may be more willing to license and accept a low price if the licensee operates in a different industry and is not likely to become a competitor through licensing, as the licensor does not need to be compensated for reduced profits resulting from intensified competition. Similarly, if the licensed technology is not closely related to the licensor's core technology, there may be greater motivation to license and accept a lower price because the licensing of such technology is unlikely to affect the licensor's profit level in its core business. This finding also supports the notion that more appropriable patents are less risky, reducing the need to use royalty rates to share risks between licensors and licensees [71].

On the other hand, when talking about type of payments, compared to lump-sum payments, the royalty rate is considered a more accurate representation of patent licensing price. In fact, in licensing contracts, 95.9% include royalty payments, while 49.9% have no lump-sum payment. The majority (91.7%) of contracts with lump-sum payments have

amounts less than about \$35,000, with the median royalty rate being 3% [110]. In this context, large licensees seem to have greater bargaining power and might prefer lump-sum payments over royalty rates to retain benefits from their large sales. Similarly, licensees with higher technological capability can better assess the market potential of licensed technology, and thus, they might prefer lump-sum payments to keep the upside potential of the rent to themselves.

### ***6.5.1 Paten license pricing in the Biopharma industry***

When examining the factors influencing pricing in patent licensing contracts within the biopharmaceutical industry (which is an industry with substantially higher licensing transfers compared to other sectors, with at least ten times the number of transfers [88]), research reveals that three critical factors significantly impacting pricing in patent licensing within the biopharmaceutical sector are Compound Annual Growth Rate (CAGR), Previous Deal Experience of the Licensor (PDELX), and Attrition Rate (AR) [73].

Moreover, when comparing academic licenses with commercial licenses, academic licenses exhibited lower effective royalty rates (median 3% compared to 8%,  $p < 0.001$ ), smaller deal sizes (median \$0.9M versus \$31.0M,  $p < 0.001$ ), and lower precommercial payments (median \$1.1M versus \$25.4M,  $p < 0.001$ ).

In this context, the factors influencing various aspects of the deal in patent licensing contracts can be ranked as follows:

- **Deal Value:**

Deal Value refers to the total monetary value of the licensing agreement between the patent holder (licensor) and the entity acquiring the license (licensee). It encompasses all financial aspects and payments involved in the deal, including upfront payments, milestone payments, and royalty payments over the term of the agreement. The Deal Value is a crucial metric that indicates the financial benefits and potential returns for both parties involved in the licensing arrangement. The Deal Value is positively influenced by Compound Annual Growth Rate (CAGR), Previous Licensor Deal experience, Licensee R&D Costs, and Licensor R&D Costs, and negatively influenced by Attrition Rate and Licensor Revenue.



In the regression model proposed [73], the equation to predict Deal Value is as follows:

$$(8) \text{ Deal Value} = 70.773093 + 5.91506 \times \text{Previous Licensor Deal experience} + 19.758378 \times \text{CAGR} - 1.963919 \times \text{Attrition Rate} + 0.176483 \times \text{Licensor R\&D Costs} - 0.028014 \times \text{Licensor Revenue} + 0.038596 \times \text{Licensee R\&D Costs}$$

- **Royalty Rate:**

The Royalty Rate is the percentage of revenue or sales that the licensee agrees to pay to the licensor as a royalty fee for using the patented technology. It is usually calculated as a fraction of the sales revenue generated by products or services that incorporate the licensed technology. For biotech patents, the royalty rate can vary depending on factors such as the uniqueness and value of the patented technology, market demand, and industry standards. Royalty Rate is positively influenced by Licensee Revenue, and negatively influenced by Licensee R&D Costs.

In the regression model, the equation to predict Royalty Rate is as follows:

$$(9) \text{ Royalty Rate} = 12.74085 - 0.00458 \times \text{Licensee R\&D Costs} + 0.000735 \times \text{Licensee Revenue}$$

- **Total Upfront Payments:**

The Total Upfront represents the initial payment made by the licensee to the licensor at the start of the licensing agreement. It is a lump-sum payment that provides the licensor with immediate financial benefits and serves as an upfront compensation for granting the license. The Total Upfront may be negotiated based on the potential value of the technology, market prospects, and the licensor's bargaining power. Total Upfront Payments are positively influenced by Previous Licensor Deal experience and Licensor R&D Costs, and negatively influenced by Licensor Revenue.

In the regression model, the equation to predict Total Upfront Payments is as follows:

$$(10) \text{ Total Upfront} = 159.46549 + 7.8125 \times \text{Licensor Deal experience} + 0.272934 \times \text{Licensor R\&D Costs} - 0.043594 \times \text{Licensor Revenue}$$

- **Milestone Payment:**

Milestones are specific events or achievements outlined in the licensing agreement that trigger additional payments from the licensee to the licensor. These events could be related to the successful development, regulatory approval, commercial launch, or reaching specific sales targets of products or services based on the licensed technology. Milestone payments are used to incentivize the licensee to achieve certain objectives and ensure continuous progress in the development and commercialization of the licensed technology. Milestone Payment is positively influenced by CAGR, Previous Licensor Deal experience, and Licensor R&D Costs, and negatively influenced by Licensor Revenue.

In the regression model, the equation to predict Milestone Payment is as follows:

$$(11) \quad \text{Milestones} = (-95.645835) + 8.039028 \times \text{Previous Licensor Deal experience} + 29.228961 \times \text{CAGR} + 0.297096 \times \text{Licensor R\&D Costs} - 0.046986 \times \text{Licensor Revenue}$$

According to the data provided [73], the minimum, maximum and mean values in the industry are shown in the following table (see Table 10):

*Table 10. Patent licensing variable summary*

Variable	Acronym	Mean	Min	Max
Previous Licensor Deal experience	PDELR (times)	30,89	0,00	145,00
Previous Licensee Deal experience	PDELE (times)	13,50	0,00	75,00
Market size Compound Annual growth Rate	MS (M\$)	82.880,00	50.100,00	125.500,00
Attrition Rate	CAGR (%)	8,56%	0,00%	10,90%
Licensor R&D Costs	AR (%)	35,56%	13,30%	93,00%
Licensor Revenue	RNDLR (M\$)	1.657,00	0,00	7.680,00
Licensor R&D Costs	SALESLR (M\$)	11.439,40	0,00	61.095,00
Licensor Revenue	RNDLE (M\$)	715,01	0,00	9.431,00
	SALESLE (M\$)	4.374,40	0,00	65.165,00

With this information, the calculated values for the deal value, royalty fee, total upfront and milestones were calculated and shown in the table below (see Table 11):

*Table 11. Patent licensing pricing variables without Blockchain*

	Value
Deal Value (M\$)	254,05
Royalty Rate (%)	6,79
Total upfront (M\$)	354,36
Milestones (M\$)	109,98

Once these values are known, it is time to calculate the impact the incorporation of the Blockchain would have. Among all the variables included in Table 10, the one that will be mostly affected are “Previous Licensor Deal experience” and “Previous Licensee Deal experience”. The reason behind is that since managing patents as NFTs increases efficiency, the number of granted patents will increase accordingly.

Assuming the number of applications and licenses of NFT-based patents will follow the same trend as NFT-trademarks [37], we assume it will follow a CAGR of 15,94%. Therefore, the number of previous experiences of both licensors and licensees (which is measured in number of times or number of deals) will increase accordingly. Under this situation, the variables will be impacted as seen in the following table (see Table 12):

*Table 12. Patent licensing pricing variables with Blockchain*

	Value
Deal Value (M\$)	283,17
Royalty Rate (%)	6,79
Total upfront (M\$)	392,82
Milestones (M\$)	149,56

This means that the total average value of the deal can see a 29,12M\$ increase (11,5% higher), which with the USD/EUR exchange rate to date July 26<sup>th</sup> [127] would be 32,36M€ In addition, it should be considered that attorney fees accounting for around 45.000\$ [109] would disappear when introducing the blockchain, leading to a total increase in revenues of 32,41M€for a patent licensor.

On the other hand, total upfront costs and specific milestones saw an increase in their prices of 38,5 M\$ and 39,6 M\$ respectively, which means a 36,0% and a 10,9% relative increase compared to the case without blockchain. These figures can be seen in the following figure (see Figure 21):

Figure 21. Licensing prices without and with the implementation of the blockchain

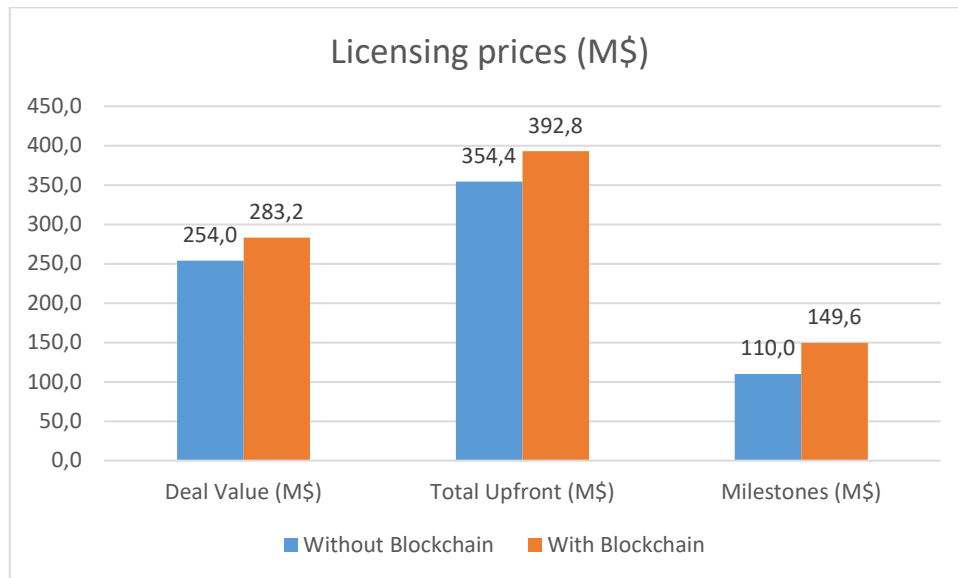

## **6. Conclusion**

The conclusion chapter of this thesis serves as a culmination of the current work, bringing together the key findings and insights obtained throughout the study. It is divided into two distinct sections, namely the discussion and conclusion, each offering valuable

insights and analysis. In the discussion, we thoroughly explore the potential advantages, challenges, and scalability concerns associated with the adoption of NFT-based patent management. Moreover, the discussion sheds light on the cost reduction benefits for both patent offices and patent holders, emphasizing the transformative potential of NFTs in revolutionizing intellectual property management. On the other hand, the conclusion aims to provide a comprehensive summary of the research outcomes, discuss the implications of the work done and the application developed, and offer recommendations for future studies. Firstly, the chapter begins with a restatement of the research objectives, reminding the reader of the primary focus of the study. This is followed by a concise summary of the main findings and limitations encountered throughout the whole process, including the research part, the development of the framework and in the economic analysis. Then, recommendations for future research directions are provided, outlining potential avenues for further exploration. Finally, the chapter concludes with a concise summary, reinforcing the overall contributions and significance of the research.

## **6.1 Discussion**

The concept of managing patents as non-fungible tokens (NFTs) presents intriguing possibilities for the intellectual property landscape. Therefore, this discussion explores the potential benefits and challenges of tokenizing patents and its implications on patent management, marketplaces, and innovation.

One of the key advantages of managing patents as NFTs is the potential to revolutionize how intellectual property rights are recorded and managed. By representing patents on a decentralized blockchain network, transparency and immutability are ensured, reducing the likelihood of disputes and infringements. NFTs can serve as a tamper-proof record of ownership and licensing details, providing a reliable source for patent validation and verification. This transparent and secure framework may enhance the efficiency and trustworthiness of patent management systems.

Moreover, the introduction of NFTs in the patent ecosystem could lead to the emergence of novel patent marketplaces. By tokenizing patents, fractional ownership becomes a possibility, enabling individuals and companies to invest in and trade smaller portions of patents. This fractionalization may democratize access to valuable patents, unlocking new opportunities for small businesses, startups, and individual inventors to participate in the

innovation ecosystem. Additionally, tokenized patents may attract new types of investors, such as venture capitalists and blockchain enthusiasts, who see potential value in patent portfolios.

Furthermore, managing patents as NFTs could potentially enable more efficient licensing and monetization strategies. Smart contracts, inherent to NFTs, can automate the licensing process and ensure that licensors receive royalty payments without intermediaries. This automation could streamline negotiations and reduce transaction costs, benefitting both patent owners and licensees. Additionally, NFT-based patent licensing could allow for dynamic pricing models, tailoring licensing agreements to the specific needs and capabilities of licensees.

Moreover, NFT-based patent management can enhance patent examination and evaluation processes. With all patent-related information recorded on the blockchain, patent offices can access a comprehensive and verifiable history of each patent. This data transparency can aid patent examiners in conducting more accurate prior art searches and assessing the novelty and non-obviousness of inventions, resulting in improved patent quality. Higher patent quality, in turn, can reduce the likelihood of patent disputes and invalidations, saving additional costs for patent offices and patent holders.

For patent holders, NFT-based patent management can bring substantial cost-saving benefits throughout the patent lifecycle. By representing patents as NFTs, the licensing and commercialization of intellectual property can be conducted more efficiently and with reduced transaction costs. Smart contracts can automate the licensing process, ensuring timely royalty payments without intermediaries, which can significantly cut administrative expenses. Moreover, fractional ownership enabled by NFTs can allow patent holders to sell or license portions of their patents, creating new revenue streams without transferring full ownership. This ability to sell fractions of patents can also lower the barriers for small inventors and startups to participate in the patent marketplace, promoting a more inclusive and diverse innovation ecosystem. Furthermore, NFTs can facilitate global licensing and patent transfer with ease. Cross-border transactions can be conducted directly on the blockchain, eliminating the need for complex legal agreements and intermediary services, thereby reducing legal fees and administrative costs associated with international patent transactions.

However, challenges exist in implementing patents as NFTs. Intellectual property law, which varies significantly across jurisdictions, may need to adapt to the novel framework of NFT-based patents. Questions related to enforceability, legal recognition, and cross-border implications will need to be addressed to ensure global compatibility and acceptance. Another concern is the potential for NFT-related patents to be subject to infringement and counterfeiting. While the blockchain technology underlying NFTs provides security, the risk of unauthorized replication or misuse of tokenized patents must be carefully considered and addressed. Consequently, there may be resistance from traditional patent institutions and stakeholders to embrace the NFT approach. Established patent systems have evolved over time, and introducing NFTs may require convincing stakeholders of their efficacy and reliability.

In addition to the potential benefits and challenges discussed earlier, it is important to address some potential scalability issues that may arise from managing patents as NFTs. As the adoption of NFTs in the patent ecosystem increases, the blockchain infrastructure supporting these tokens may face scalability challenges. Blockchain networks, like Ethereum, which are commonly used for NFTs, have limitations in terms of transaction throughput and processing speed. With an influx of patent-related NFT transactions, there could be a strain on the network's capacity, leading to higher fees and slower transaction times. Scalability solutions and advancements in blockchain technology will be essential to ensure a smooth and efficient patent management system.

Furthermore, the dependency on gas prices in blockchain transactions is a significant consideration for managing patents as NFTs. Gas refers to the fees paid to miners to validate and process transactions on the blockchain. As the demand for NFTs grows, the cost of gas may fluctuate, leading to variable transaction costs. This dependency on gas prices could impact the overall cost-effectiveness of managing patents as NFTs, particularly for high-frequency transactions or during periods of high network congestion. Ensuring cost predictability and stability will be crucial to encourage widespread adoption of NFT-based patent management. To address these scalability and gas price concerns, research and development efforts must focus on optimizing blockchain protocols and exploring alternative, more scalable networks.

In addition, managing patents as NFTs can also offer significant cost reduction advantages for both patent offices and patent holders. For patent offices, adopting NFT-



based patent management systems can streamline the administrative processes involved in patent registration, licensing, and enforcement. The transparent and tamper-proof nature of blockchain technology can reduce the need for extensive paperwork, document verification, and manual record-keeping. This digitization of patent data and processes can lead to increased operational efficiency, reduced administrative costs, and faster turnaround times for patent applications and approvals.

## **6.2 Work conclusions**

The main objective of this thesis was to analyze the potential of Non-Fungible Tokens (NFTs) in industrial property management, providing a thorough examination of the feasibility and benefits of incorporating NFTs and blockchain technology into the patent system. This objective was achieved through three specific objectives that have been diligently pursued throughout the entire research process. First, the study examined the legal aspects, technological functionalities, and economic considerations of patents as NFTs, to contribute valuable insights and provide a foundation for informed decision-making in the field of industrial property management. Second, a framework or architecture for managing patents was designed which included the development of a smart contract based on the blockchain for managing patents as NFTs. Finally, economic implications of adopting the proposed NFT-based patent framework would have on the national and in international patent offices were examined.

Besides, the findings of this study demonstrate that NFTs and the underlying blockchain network offer a promising solution for proving ownership and facilitating the trading of assets, including patents. The unique characteristics of NFTs, such as indivisibility, immutability, and traceability, provide an innovative approach to industrial property management. In addition, the ability to tokenize patents as NFTs opens up new avenues for secure and transparent transactions, enabling greater accessibility and liquidity within the patent ecosystem. Moreover, this technology, being still in early stages and thanks to its programable nature, provides numerous possibilities for personalization and scalability.

However, it is crucial to recognize that the legal framework for the transfer of industrial property through the blockchain is still in its infancy. This factor becomes of paramount importance considering patents are industrial property assets that are managed by a

central government institution, and NFTs, on the other hand, are part of a completely decentralized technology. Therefore, while the benefits of utilizing NFTs in patent management are evident, the lack of established regulations poses a significant hurdle for practical implementation, which is one of the reasons why patents as NFTs are still not a reality. This situation is what inspired the idea of a hybrid framework, since without an established legal environment, a completely blockchain-based patent system has no value or real applicability.

Moreover, although advantages of decentralized systems for patent management were identified in the study, including increased transparency, reduced reliance on intermediaries, and enhanced security, it has also been discovered that the full decentralization of the current patent system poses technical and practical challenges that need to be carefully considered. The immutability of blockchain records, while ensuring data integrity, may hinder the flexibility required for certain patent-related actions. Additionally, the transition to a fully decentralized system would require significant time and effort to overcome the existing infrastructural and organizational barriers.

For these reasons, this work, which explores the management of patents as NFTs, is prepared to revolutionize the way patent offices operate and interact with the global patent ecosystem. The proposed architecture offers a seamless transition to blockchain technology, facilitating greater efficiency and reliability in patent management. By leveraging NFTs, patent offices can establish a decentralized and open repository of patents, providing an innovative solution that is currently lacking in the intellectual property landscape. The developed smart contract paves the way for international patent offices to interconnect and collaborate, creating a cohesive and accessible global patent system. This interconnectedness fosters cooperation, enhances security, and boosts the liquidity of patent assets.

Nevertheless, throughout the development of this master thesis, several limitations were encountered. The nascent nature of blockchain technology, particularly in the context of industrial property management, limited the availability of extensive literature and established frameworks. This situation led to the necessity to access certain non-scientific articles in webpages, which are not as reliable. On the other hand, being such a novel technology, personal knowledge limitations and the complexity of the subject matter

required diligent research and continuous learning (including programming) to ensure accurate results.

Regarding the economic analysis, for the sake of simplicity, certain variables were excluded from the analysis. It is important to acknowledge that these variables could have an impact on the overall benefits and costs of implementing blockchain in the patent system. Among the factors that could potentially increase the benefits are the possibility of charging a fee per transaction, which could generate additional revenue and enhance the financial outcome (usually around 2,5%). Furthermore, if all patent offices globally adopted a blockchain-based system, there would be efficiency gains through shared resources, leading to a reduction of duplicate efforts and administrative costs estimated at 10-15% through global collaboration and the sharing of patent information.

On the other hand, there are factors that could increase costs. One such factor is the need for training and updating the skills of the workforce. While the employees already receive training, the implementation of blockchain might require additional investments in training programs to ensure their proficiency in this new technology. Additionally, for the successful implementation of blockchain in the Spanish patent system, a user-friendly and intuitive interface or application would be essential. Developing such an interface internally or engaging a third-party service provider could result in additional costs for the OEPM.

To drive future research and advancements, it is recommended to explore ways for the establishment of a legal framework for blockchain-based patent transactions. Collaboration between academia, patent offices, legal institutions, and policymakers is vital to ensure the smooth integration of blockchain technology into the existing patent system. Additionally, further research should focus on refining and expanding the developed framework, incorporating advanced functionalities, like procedures for self-validating authorities, and addressing the identified limitations like the scalability of the current smart contract. Moreover, it is crucial that enterprises and governments start getting more involved in this technology so that the overall value for society increases, leading to more investments and further development and establishments of the technology.

In conclusion, this master thesis contributes to the growing body of knowledge on NFTs and blockchain technology in industrial property management. While the road to a fully decentralized and blockchain-based patent system may present challenges, the potential benefits are substantial. By embracing innovation, fostering collaboration, and addressing the legal and technical considerations, patent offices can unlock new opportunities for efficiency, transparency, and intellectual property protection. Ultimately, the outcome of this thesis holds the potential to propel the patent system into a new era, marked by increased accessibility, transparency, and collaboration across borders, transforming the landscape of industrial property management.

## 7. Bibliography

1. Academy, B. (2023, March 31). ¿Cómo funciona la Cadena de Bloques (Blockchain)?- Bit2Me Academy. Bit2Me Academy. <https://academy.bit2me.com/como-funciona-blockchain-cadena-de-bloques/>
2. Academy, B. (2023b). What's the Relationship Between Blockchain and Web3? Binance Academy. <https://academy.binance.com/en/articles/what-s-the-relationship-between-blockchain-and-web3>
3. Afolabi, O. (2023). What Is Byzantine Fault Tolerance, and How Does It Ensure Blockchain Stability? MUO. <https://www.makeuseof.com/what-is-byzantine-fault-tolerance-blockchain-stability/#:~:text=Byzantine%20fault%20tolerance%20refers%20to,participants%20are%20reliable%20and%20genuine.>
4. Aharon, D. Y., & Demir, E. (2021). NFTs and asset class spillovers: Lessons from the period around the COVID-19 pandemic. *Finance Research Letters*, 47, 102515.
5. Al Tamimi & Company. (2022, February 25). NFTs, Intellectual Property and Other Legal Considerations: A Wake-Up Call - Al Tamimi & Company. <https://www.tamimi.com/law-update-articles/nfts-intellectual-property-and-other-legal-considerations-a-wake-up-call/>
6. Ante, L. (2022b). The Non-Fungible Token (NFT) Market and Its Relationship with Bitcoin and Ethereum. *FinTech*, 1(3), 216–224.
7. Arora, A., A. Fosfuri (2003), 'Licensing the Market for Technology', *Journal of Economic Behavior and Organization*, 52, 277–295.
8. Asymmetric Encryption: Definition, Architecture, Usage | Okta. (n.d.). Okta, Inc. [https://www.okta.com/identity-101/asymmetric-encryption/#:~:text=Asymmetric%20encryption%20\(also%20known%20as,see%20what%20you've%20written.](https://www.okta.com/identity-101/asymmetric-encryption/#:~:text=Asymmetric%20encryption%20(also%20known%20as,see%20what%20you've%20written.)
10. Bala, R., & Suryavanshi, S. (2022). NFT Revolution: The Intersection of Patents and NFT. Lexology. <https://www.lexology.com/library/detail.aspx?g=3dc44b74-b0f5-4015-b51c-6033c3126a1f>
11. Bamakan, S. M. H., Motavali, A. & Bondarti, A. B. A survey of blockchain consensus algorithms performance evaluation criteria. *Expert Systems with Applications* 154, 113385 (2020)
12. Bamakan, S. M. H., Nezhadsistani, N., Bodaghi, O., & Qu, Q. (2021). A Decentralized Framework for Patents and Intellectual Property as NFT in Blockchain Networks. *Research Square (Research Square)*. <https://doi.org/10.21203/rs.3.rs-951089/v1>

13. Bamakan, S. M. H., Nezhadsistani, N., Bodaghi, O., & Qu, Q. (2022). Patents and intellectual property assets as non-fungible tokens; key technologies and challenges. *Scientific Reports*, 12(1), 2178. <https://doi.org/10.1038/s41598-022-05920-6>
14. BankPedia |. (n.d.). [https://www.bankpedia.org/termine.php?lingua=en&c\\_id=23701-intellectual-property-right](https://www.bankpedia.org/termine.php?lingua=en&c_id=23701-intellectual-property-right)
15. Bao, H., & Roubaud, D. (2021b). Recent Development in Fintech: Non-Fungible Token. *FinTech*, 1(1), 44–46. <https://doi.org/10.3390/fintech1010003>
16. Benet, J.: Ipfs-content addressed, versioned, p2p file system. arXiv preprint arXiv:1407.3561 (2014)
17. Benisi, N. Z., Aminian, M. & Javadi, B. Blockchain-based decentralized storage networks: A survey. *Journal of Network and Computer Applications* 162, 102656 (2020).
18. Benson, J.: Your nfts can go missing—here’s what you can do about it. <https://decrypt.co/62037/missing-or-stolen-nfts-how-to-protect> (2021)
19. Berners-Lee, T. (2000). *Weaving the Web: The Original Design and Ultimate Destiny of the World Wide Web by Its Inventor*. Harper Business.
20. bigredawesomedodo. *Helping Small Businesses Survive and Grow With Marketing*, (2020).
21. Binance. (n.d.a). *Binance Smart Chain*. Retrieved from <https://www.binance.org/en/smartChain>
22. Binance. (n.d.b). *Binance Smart Chain Technical Overview*. Retrieved from <https://docs.binance.org/smart-chain/developer/overview.html>
23. Bindseil, U. (2022, November 30). Bitcoin’s last stand. European Central Bank. <https://www.ecb.europa.eu/press/blog/date/2022/html/ecb.blog221130~5301eecd19.en.html#:~:text=The%20value%20of%20bitcoin%20peaked,has%20fluctuated%20around%20USD%2020%2C000.>
24. Biswas, S. (2023). What Is NFT Wallet: Its Significance And How To Select It? *Cleartax*. <https://cleartax.in/s/nft-wallets>
25. Bit2Me Academy. (2018, junio 22). ¿Cómo funciona la Cadena de Bloques (Blockchain)? Bit2Me Academy. <https://academy.bit2me.com/como-funciona-blockchain-cadena-de-bloques/>
26. Bit2Me Academy. (2020, mayo 5). ¿Qué es un nodo? Bit2Me Academy. <https://academy.bit2me.com/que-es-un-nodo/>
27. Bonnet, S., & Teuteberg, F. (2023). Impact of blockchain and distributed ledger technology for the management of the intellectual property life cycle: A multiple case study analysis. *Computers in Industry*, 144(103789), 103789. <https://doi.org/10.1016/j.compind.2022.103789>

28. BraggCrypto trading volumes almost halved in 2022. InvestorDaily. <https://www.investordaily.com.au/markets/52669-crypto-trading-volumes-almost-halved-in2022#:~:text=While%20Bitcoin%20suffered%20a%2031.4,volume%20of%20US%243.36%20trillion.>
29. Buterin, V. A next-generation smart contract and decentralized application platform. white paper 3 (2014).
30. Buterin, V. (2019). On Public and Private Blockchains. Retrieved from <https://vitalik.ca/general/2019/04/03/publicprivate.html>
31. Casino, F., Dasaklis, T. K. & Patsakis, C. A systematic literature review of blockchain-based applications: Current status, classification and open issues. *Telematics and informatics* 36, 55-81 (2019)
32. Caves, R. E., H. Crookwell, J. P. Killing (1983), 'The Imperfect Market for Technology Licenses', Oxford
33. *Bulletin of Economics and Statistics*, 45, 249–267.
34. Christie's Bepple (b. 1981). Available online: <https://onlineonly.christies.com/s/first-open-beeple/beeple-b-1981-1/112924>
35. ConsenSys. (2021). Non-Fungible Tokens: What Are They and How Do They Work? Retrieved from <https://consensys.net/learn/blockchain-basics/non-fungible-tokens-nfts/>
36. Contractor, F.J. (1981), *International Technology Licensing: Compensation, Costs and Negotiation*. D.C. Heath: Lexington, MA.
37. Cryptoflies. (2023, June 12). Do metaverse and NFTs have a future? These statistics on trademark filings will convince you (Updated June . . . Cryptoflies News. <https://blog.cryptoflies.com/do-metaverse-and-nfts-have-a-future-these-statistics-on-trademark-fillings-will-convince-you/>
38. Decentraland (mana). Project accessible: <https://decentraland.org/> (2020)
39. Desk, S. (2023, February 18). How Does Patenting Work for NFTs? Vakilsearch | Blog. <https://vakilsearch.com/blog/how-does-patenting-work-for-nfts/>
40. Dowling, M. (2021). Is non-fungible token pricing driven by cryptocurrencies? *Social Science Research Network*. <https://doi.org/10.2139/ssrn.3815093>
41. Editorial Colex. (n.d.). Iberley. Contenido Jurídico. <https://www.iberley.es/temas/solicitud-procedimiento-concesion-patente-62555>
42. Ethereum. (n.d.). Gas and Fees. Retrieved from <https://ethereum.org/gas/>
43. Ethereum. (n.d.). Gas, Block Gas Limit, and Gas Price. Retrieved from <https://ethereum.org/gas/>
44. Ethereum. (n.d.). What is Ethereum? | ethereum.org. [ethereum.org. https://ethereum.org/en/what-is-ethereum/](https://ethereum.org/en/what-is-ethereum/)

45. Ethereum Average Gas Price Chart | Etherscan. (n.d.). <https://etherscan.io/chart/gasprice>
46. European Patent Office (EPO) - Spain. Retrieved from <https://www.epo.org/about-us/office/spanish.html>
47. Ezell, S., & Cory, N. (2022). The Way Forward for Intellectual Property Internationally. ITIF. <https://itif.org/publications/2019/04/25/way-forward-intellectual-property-internationally/>
48. Fabiana. (2023). ¿Cómo funcionan los Smart Contracts? Skiller. <https://skiller.education/como-funcionan-los-smart-contracts/>
49. Frizzo-Barker, J. et al. Blockchain as a disruptive technology for business: A systematic review. *International Journal of Information Management* 51, 102029 (2020)
50. Fulber-Garcia, V. (2023). Public/Private Keys Vs. Certificates | Baeldung on Computer Science. Baeldung on Computer Science. <https://www.baeldung.com/cs/public-private-keys-vs-certificates>
51. Gambardella, A., P. Giuri, A. Luzzi (2007), 'The Market for Patents in Europe', *Research Policy*, 36, 1163–1183.
52. Gipp, B., Meuschke, N. & Gernandt, A. Decentralized trusted timestamping using the crypto currency bitcoin. arXiv preprint arXiv:1502.04015 (2015).
53. Gondek, C. (n.d.). What is the Ethereum Virtual Machine?. OriginStamp. [https://originstamp.com/blog/what-is-the-ethereum-virtual-machine-beginners-guide/#:~:text=The%20Ethereum%20Virtual%20Machine%20\(EVM,written%20into%20lines%20of%20code.](https://originstamp.com/blog/what-is-the-ethereum-virtual-machine-beginners-guide/#:~:text=The%20Ethereum%20Virtual%20Machine%20(EVM,written%20into%20lines%20of%20code.)
54. Gschossmann, I. (2022, July 11). Mining the environment – is climate risk priced into crypto-assets? European Central Bank. [https://www.ecb.europa.eu/pub/financial-stability/macprudential-bulletin/html/ecb.mpbu202207\\_3~d9614ea8e6.en.html](https://www.ecb.europa.eu/pub/financial-stability/macprudential-bulletin/html/ecb.mpbu202207_3~d9614ea8e6.en.html)
55. Hammi, M. T., Bellot, P. & Serhrouchni, A. in 2018 IEEE Wireless Communications and Networking Conference (WCNC). 1-6 (IEEE).
56. Hayes, A. (2023). Blockchain Facts: What Is It, How It Works, and How It Can Be Used. Investopedia. <https://www.investopedia.com/terms/b/blockchain.asp#:~:text=Simply%20put%2C%20a%20blockchain%20is,one%20copy%20of%20the%20ledger.>
57. Hayward, A. (2023, January 4). NFT Sales in 2022 Nearly Matched the 2021 Boom, Despite Market Crash. Decrypt. <https://decrypt.co/118438/2022-versus-2021-nft-sales>
58. Helliär, C. V., Crawford, L., Rocca, L., Teodori, C. & Veneziani, M. Permissionless and permissioned blockchain diffusion. *International Journal of Information Management* 54, 102136 (2020).



59. Hellwig, C. (2022, July 19). NFT Smart Contract Development – Road to OpenSea (Part 2). SAP Community. <https://blogs.sap.com/2022/07/18/nft-smart-contract-development-road-to-opensea-part-2/>
60. Herranz, A. (2021). Así se reparte el mercado cloud: los tres grandes tienen el 63%, los siguientes 10 un 22%. Xataka. <https://www.xataka.com/pro/asi-se-reparte-mercado-cloud-tres-grandes-tienen-63-siguientes-10-22>
61. How does patenting work for NFTs? (2022, junio 21). Vakilsearch | Blog. <https://vakilsearch.com/blog/how-does-patenting-work-for-nfts/>
62. INE - Instituto Nacional de Estadística. (n.d.-a). INEbase / Nivel y condiciones de vida (IPC) / Índices de precios de consumo y vivienda / Índice de precios de consumo / Últimos datos. INE. [https://www.ine.es/dyngs/INEbase/es/operacion.htm?c=Estadistica\\_C&cid=1254736176802&menu=ultiDatos&idp=1254735976607#:~:text=%C3%9Altima%20Nota%20de%20prensa&text=La%20tasa%20de%20variaci%C3%B3n%20anual,de%20la%20registrada%20en%20mayo.](https://www.ine.es/dyngs/INEbase/es/operacion.htm?c=Estadistica_C&cid=1254736176802&menu=ultiDatos&idp=1254735976607#:~:text=%C3%9Altima%20Nota%20de%20prensa&text=La%20tasa%20de%20variaci%C3%B3n%20anual,de%20la%20registrada%20en%20mayo.)
63. IPwe and IBM Seek to Transform Corporate Patents With Next Generation NFTs Using IBM Blockchain. (2021b, April 20). IBM Newsroom. <https://newsroom.ibm.com/2021-04-20-IPwe-and-IBM-Seek-to-Transform-Corporate-Patents-With-Next-Generation-NFTs-Using-IBM-Blockchain>
64. Jablonski, S. (2021, June 9). Are NFTs The New Crypto? A Guide To Understanding Non-Fungible Tokens. Forbes. <https://www.forbes.com/sites/forbesbusinesscouncil/2021/06/09/are-nfts-the-new-crypto-a-guide-to-understanding-non-fungible-tokens/>
65. Jaffe, A.B., J. Lerner (2004), Innovation and Its Discontents: How Our Broken Patent System Is
66. Endangering Innovation and Progress, and What to Do about It. Princeton University Press:
67. Princeton, NJ.
68. Katz, M. L., C. Shapiro (1985), 'On the Licensing of Innovations', RAND Journal of Economics, 16,
69. 504–520.
70. Khalid, U. et al. A decentralized lightweight blockchain-based authentication mechanism for IoT systems. Cluster Computing, 1-21 (2020).
71. Lafontaine, F. (1992), 'Agency Theory and Franchising: Some Empirical Results', RAND Journal of Economics, 23, 263–283.
72. La Propiedad Industrial y la Oficina Española de Patentes y Marcas (n.d.). [https://administracion.gob.es/pag\\_Home/Tu-espacio-europeo/derechos-](https://administracion.gob.es/pag_Home/Tu-espacio-europeo/derechos-)

[obligaciones/empresas/inicio-gestion-cierre/derechos/patentes-marcas/propiedad-industrial.html#-fe204c41950f](#)

73. Lee, J., Kim, E., Sung, T., & Shin, K. (2018). Factors affecting pricing in patent licensing contracts in the biopharmaceutical industry. *Sustainability*, 10(9), 3143. <https://doi.org/10.3390/su10093143>
74. Lee, Y. (2016). Innovation Management of Patent Commercialization. CORE. [https://core.ac.uk/display/228834334?utm\\_source=pdf&utm\\_medium=banner&utm\\_campaign=pdf-decoration-v1](https://core.ac.uk/display/228834334?utm_source=pdf&utm_medium=banner&utm_campaign=pdf-decoration-v1)
75. Manual Informativo para los Solicitantes de Patentes (n.d.). <https://docplayer.es/3110714-Manual-informativo-para-los-solicitantes-de-patentes.html>
76. Martens, D., Tuyll van Serooskerken, A. v. & Steenhagen, M. Exploring the potential of blockchain for KYC. *Journal of Digital Banking* 2, 123-131 (2017)
77. Maurya, A. (2023, January 26). The Difference Between Web 1.0, Web 2.0, Web 3.0 - IMPACTMILLIONS. IMPACTMILLIONS. <https://www.impactmillions.org/the-difference-between-web-1-0-web-2-0-web-3-0/>
78. Ministerie van Economische Zaken en Klimaat. (2016, March 31). What are the criteria for patenting my invention? Government.nl. <https://www.government.nl/topics/intellectual-property/question-and-answer/what-are-the-criteria-for-patenting-my-invention>
79. Müller, T. (2021). Cómo afectan la NFT y las criptomonedas a la economía real - MoreThanDigital. MoreThanDigital. <https://morethandigital.info/es/como-afectan-la-nft-y-las-criptomonedas-a-la-economia-real/>
80. Nadini, M., Alessandretti, L., Di Giacinto, F., & Baronchelli, A. (2021). Mapping the NFT revolution: market trends, trade networks and visual features. ResearchGate. [https://www.researchgate.net/publication/352053853\\_Mapping\\_the\\_NFT\\_revolution\\_market\\_trends\\_trade\\_networks\\_and\\_visual\\_features](https://www.researchgate.net/publication/352053853_Mapping_the_NFT_revolution_market_trends_trade_networks_and_visual_features)
81. Nakamoto, S. (2008). Bitcoin: A Peer-to-Peer Electronic Cash System. Retrieved from <https://bitcoin.org/bitcoin.pdf>
82. Newton Media. (n.d.). The NFT revolution: what will tokenisation mean for patents? World IP Review. <https://www.worldipreview.com/article/the-nft-revolution-what-will-tokenisation-mean-for-patents>
83. NFT: ¿Qué son y por qué son dañinos para el medioambiente? (s/f). Edu.pe. <https://www.esan.edu.pe/conexion-esan/nft-que-son-y-por-que-son-daninos-para-el-medioambiente>
84. NFTReview. On-chain vs. (Off-chain Metadata, 2021).

85. NFTs and Intellectual Property. (2023, May 9). Practical Law the Journal. <https://www.reuters.com/practical-law-the-journal/transactional/nfts-intellectual-property-2023-02-01/>
86. nft.storage. Free Storage for NFTs, (2021).
87. NFT-Ticketing. NFT Ticketing with Blockchain Technology, (2020)
88. Nigel Borshell, N.; Ahmed, T. Approaches to Valuation of Pharmaceutical Licensing Deals. Pharma
89. Ventures. 2012. Available online: [http://files.pharmadeals.net/contents/Sample\\_Valuation.pdf](http://files.pharmadeals.net/contents/Sample_Valuation.pdf) (accessed on 1 March 2018).
90. 1 March 2018).
91. Nizamuddin, N., Salah, K., Azad, M. A., Arshad, J. & Rehman, M. Decentralized document version control using ethereum blockchain and IPFS. Computers & Electrical Engineering 76, 183-197 (2019).
92. OLCreat: Entrepreneurship Accelerator Managing and protecting your intellectual property: 1 What is intellectual property? (n.d.). <https://www.open.edu/openlearncreate/mod/oucontent/view.php?id=144931&ion=2>
93. OpenSea. (n.d.). NFT Basics - How to Buy, Sell, and Create NFTs. Retrieved from <https://opensea.io/blog/guides/non-fungible-tokens/>
94. O'Reilly, T. (2005). What Is Web 2.0: Design Patterns and Business Models for the Next Generation of Software. O'Reilly Media.
95. Patentes: conociendo los principales beneficios para proteger invenciones - blog visualización - Indecopi. (s/f). Patenta.pe. <https://www.patenta.pe/-/patentes-conociendo-los-principales-beneficios-para-proteger-invenciones>
96. Patent Requirements (BitLaw). (n.d.). <https://www.bitlaw.com/patent/requirements.html>
97. Patents. (n.d.). <https://www.wipo.int/patents/en/>
98. Patents. (n.d.-b). IP Helpdesk. [https://intellectual-property-helpdesk.ec.europa.eu/patents\\_en](https://intellectual-property-helpdesk.ec.europa.eu/patents_en)
99. Patents on NFT? No, NFT on patents! (s/f). Schoenherr.Eu. <https://www.schoenherr.eu/content/patents-on-nft-no-nft-on-patents/>
100. PCT – The International Patent System. (n.d.). <https://www.wipo.int/pct/en/>
101. Proposals, E. I. (2018). ERC-721: Non-Fungible Token Standard. Ethereum Improvement Proposals. <https://eips.ethereum.org/EIPS/eip-721>
102. Proposals, E. I. (2018b). ERC-1155: Multi Token Standard. Ethereum Improvement Proposals. <https://eips.ethereum.org/EIPS/eip-1155>
103. Psaras, Y. & Dias, D. in 2020 50th Annual IEEE-IFIP International Conference on Dependable Systems and Networks-Supplemental Volume (DSN-S). 80-80 (IEEE).

104. ¿Qué es la tecnología Blockchain? - IBM Blockchain. (s/f). Ibm.com. [://www.ibm.com/es-es/topics/what-is-blockchain](https://www.ibm.com/es-es/topics/what-is-blockchain)
105. Raja Santhi, A., & Muthuswamy, P. (2022). Influence of Blockchain Technology in Manufacturing Supply Chain and Logistics. *Logistics*, 6(1), 15. <https://doi.org/10.3390/logistics6010015>
106. Rehm, B. S. F. C. a. P., CPA. (2022, October 1). What CPAs need to know about NFTs. *Journal of Accountancy*. <https://www.journalofaccountancy.com/issues/2022/oct/what-cpas-need-to-know-about-nfts.html>
107. Rivero, T. (2022, abril 9). El lado más oscuro de los NFTs no son las estafas que se hacen con ellos. *Hipertextual*. <https://hipertextual.com/2022/04/tus-nft-estan-contaminando-mas-al-medio-ambiente>
108. Rockett, K. (1990), ‘The Quality of Licensed Technology’, *International Journal of Industrial Organization*, 8, 559–574
109. Russkrajec. (2023). How much do patent attorneys charge. *BlueIron IP*. <https://blueironip.com/how-much-do-patent-attorneys-charge/>
110. Sakakibara, Mariko, An Empirical Analysis of Pricing in Patent Licensing Contracts (October 20, 2009). Available at SSRN: <https://ssrn.com/abstract=1515163> or <http://dx.doi.org/10.2139/ssrn.1515163>
111. Salgado. B (2022). Los Non Fungible Tokens (NFT) como herramienta de comunicación de marketing en la era digital.
112. Schönhals, A., Hepp, T. & Gipp, B. in *Proceedings of the 1st Workshop on Cryptocurrencies and Blockchains for Distributed Systems*. 105-110.
113. Scotchmer, S. (1991), ‘Standing on the Shoulders of Giants: Cumulative Research and the Patent Law’, *Journal of Economic Perspectives*, 5, 29–41.
114. Sede Electrónica. (n.d.). <https://sede.oepm.gob.es/eSede/es/patentes/patente-nacional/>
115. Shah P, Vaughan G, Ledley FD (2023) Comparing the economic terms of biotechnology licenses from academic institutions with those between commercial firms. *PLoS ONE* 18(3): e0283887. <https://doi.org/10.1371/journal.pone.0283887>
116. Sharma, R. (2023). Non-Fungible Token (NFT): What It Means and How It Works. *Investopedia*. <https://www.investopedia.com/non-fungible-tokens-nft-5115211>
117. Solana. (n.d.a). About Solana. Retrieved from <https://solana.com/>
118. Spanish Patent and Trademark Office (OEPM) - About Us. Retrieved from [https://www.oepm.es/en/la\\_oficina/la\\_oepm\\_en.html](https://www.oepm.es/en/la_oficina/la_oepm_en.html)
119. Statista. (2023, June 13). Ethereum ETH/USD price history up until Jun 12, 2023. <https://www.statista.com/statistics/806453/price-of-ethereum/>
120. Swan, M. (2015). *Blockchain: Blueprint for a New Economy*. O'Reilly Media.

121. Tanner, J. & Roelofs, C. NFTs and the need for Self-Sovereign Identity, 2021).
122. Teece, D. J. (1986), 'Profiting from Technological Innovation: Implications for Integration, Collaboration. Licensing and Public Policy', *Research Policy*, 15, 285–305.
123. Tut, K. Who Is Responsible for NFT Data?, 2020.
124. Umar, Z.; Gubareva, M.; Teplova, T.; Tran, D.K. COVID-19 impact on NFTs and major asset classes interrelations: Insights from the wavelet coherence analysis. *Financ. Res. Lett.* 2021, 47, 102725.
125. Understanding Industrial Property. (n.d.). [www.wipo.int. https://doi.org/10.34667/tind.28945](https://www.wipo.int/https://doi.org/10.34667/tind.28945)
126. USD EUR | US Dollar Euro - Investing.com. (n.d.). Investing.com. <https://www.investing.com/currencies/usd-eur>
127. Wang, G. & X. C. & W. D. & Z. L. (2019). When Bitcoin meets economic policy uncertainty (EPU): Measuring risk spillover effect from EPU to Bitcoin. [ideas.repec.org. https://ideas.repec.org/a/eee/finlet/v31y2019ics1544612318305749.html](https://ideas.repec.org/a/eee/finlet/v31y2019ics1544612318305749.html)
128. Wang, Q., Li, R., Wang, Q., & Chen, S. (2021). Non-Fungible Token (NFT): Overview, Evaluation, Opportunities and Challenges. ResearchGate. [https://www.researchgate.net/publication/351656444\\_Non-Fungible\\_Token\\_NFT\\_Overview\\_Evaluation\\_Opportunities\\_and\\_Challenges](https://www.researchgate.net/publication/351656444_Non-Fungible_Token_NFT_Overview_Evaluation_Opportunities_and_Challenges)
129. What are NFTs and how do they work? (2023, April 19). [www.kaspersky.com. https://www.kaspersky.com/resource-center/definitions/what-is-an-nft](https://www.kaspersky.com/resource-center/definitions/what-is-an-nft)
130. What are smart contracts on blockchain? | IBM. (n.d.). <https://www.ibm.com/topics/smart-contracts>
131. What Does a Patent Do | UpCounsel 2023. (n.d.). UpCounsel. <https://www.upcounsel.com/what-does-a-patent-do>
132. What is a gas fee? (n.d.). <https://www.scorechain.com/resources/crypto-glossary/gas-fee>
133. What is a protocol? (n.d.). Coinbase. [https://www.coinbase.com/learn/crypto-basics/what-is-a-protocol?\\_\\_cf\\_chl\\_f\\_tk=ggu9A2gowP1WTsIfouJzmH9mBAW0AFcZtV3zr7IiiVo-1686754359-0-gaNycGzNC2U](https://www.coinbase.com/learn/crypto-basics/what-is-a-protocol?__cf_chl_f_tk=ggu9A2gowP1WTsIfouJzmH9mBAW0AFcZtV3zr7IiiVo-1686754359-0-gaNycGzNC2U)
134. What is NFT token metadata or URI? (n.d.). Ethereum Stack Exchange. [https://ethereum.stackexchange.com/questions/139880/what-is-nft-token-metadata-or-uri#:~:text=So%20tokenURI\(\)%20is%20the,to%20the%20NFT%20is%20stored.](https://ethereum.stackexchange.com/questions/139880/what-is-nft-token-metadata-or-uri#:~:text=So%20tokenURI()%20is%20the,to%20the%20NFT%20is%20stored.)
135. Wilson, K. S., Karg, A., & Ghaderi, H. (2021). Prospecting non-fungible tokens in the digital economy: Stakeholders and ecosystem, risk and opportunity. *Business Horizons*, 65(5), 657–670. <https://doi.org/10.1016/j.bushor.2021.10.007>

136. World Intellectual Property Organization (WIPO). Retrieved from <https://www.wipo.int/portal/en/index.html>
137. WTO | intellectual property - overview of TRIPS Agreement. (n.d.). [https://www.wto.org/english/tratop\\_e/trips\\_e/intel2\\_e.htm](https://www.wto.org/english/tratop_e/trips_e/intel2_e.htm)
138. Yahoo is part of the Yahoo family of brands. (n.d.). [https://finance.yahoo.com/quote/ETH-USD/history/?fr=sycsrp\\_catchall&guccounter=1](https://finance.yahoo.com/quote/ETH-USD/history/?fr=sycsrp_catchall&guccounter=1)
139. Zhong, Y. et al. Distributed Blockchain-Based Authentication and Authorization Protocol for Smart Grid. *Wireless Communications and Mobile Computing 2021* (2021).

## 8. Annex I: Glossary

*Table 13. Glossary*

<b>Name (English)</b>	<b>Name (Spanish)</b>	<b>Acronym</b>	<b>Definition</b>
Amazon Web Services	Servicios en la nube de Amazon	AWS	A cloud computing platform that provides various services and tools for businesses and individuals to build and manage their applications and services.
Binance Coin	Moneda Binance	BNB	The native cryptocurrency of the Binance cryptocurrency exchange, used for various purposes within the Binance ecosystem.
Binance Smart Chain	Binance Smart Chain	BSC	A blockchain platform developed by Binance that enables the creation of smart contracts and decentralized applications with high performance and low fees.
Bitcoin	Bitcoin	BTC	The first and most well-known cryptocurrency, created as a decentralized digital currency that operates on a peer-to-peer network without the need for a central authority.
Bitcoin blockchain	Cadena de Bloques Bitcoin	N/A	The public ledger that records all Bitcoin transactions in a chronological order, ensuring transparency and security within the Bitcoin network.
Byzantine-fault-tolerant	Byzantine-fault-tolerant	BFT	A characteristic of a distributed system that can continue to operate correctly and reach consensus even if some of its components fail or behave maliciously.

Analysis of Non-Fungible Tokens (NFTs) from an Industrial Property perspective.

Chain of Custody	Cadena de Custodia	CoC	A documented and unbroken trail that shows the custody, control, transfer, and analysis of physical or digital evidence.
Compound Average Growth Rate	Tasa Compuesta de Crecimiento Promedio	CAGR	A measure used to calculate the average annual growth rate of an investment over a specified period of time, taking into account the effects of compounding.
Content-Identifiers	Identificadores de contenido	CID	A unique identifier that references data or content stored on IPFS, allowing for easy retrieval and verification of the data.
Decentralized Applications	Aplicaciones descentralizadas	Dapps	Applications that run on a decentralized network of computers rather than a central server, offering increased transparency and security.
Decentralized Finance	Finanzas descentralizadas	DeFi	A term used to describe the use of blockchain technology and cryptocurrencies to recreate traditional financial systems in a decentralized and more accessible manner.
Decentralized Identity	Identidad Descentralizada	DID	A system that allows individuals to control their own digital identities and personal data without the need for a central authority.
Distributed Hash Tables	Tablas Hash Distribuidas	DHT	A distributed system that enables data storage and retrieval across a network by using a hash table structure.
Distributed ledger	Registro Distribuido	DL	A digital record of transactions or data that is stored and synchronized across multiple locations or nodes in a network.



Analysis of Non-Fungible Tokens (NFTs) from an Industrial Property perspective.

Ethereum Request for Comment-1155	Contrato de Token No Fungible -1155	ERC-115	A proposed standard for representing non-fungible tokens (NFTs) on the Ethereum blockchain, addressing certain limitations of the ERC-721 standard.
Ethereum Request for Comment-721	Contrato de Token No Fungible -721	ERC-721	A widely adopted standard for creating and managing NFTs on the Ethereum blockchain, defining the interface for non-fungible tokens.
Ether	Ether	ETH	The native cryptocurrency of the Ethereum blockchain, used as a means of payment for transactions and to execute smart contracts.
Ethereum blockchain	Cadena de bloques Ethereum	N/A	A decentralized blockchain platform that enables the creation of smart contracts and decentralized applications.
Ethereum Virtual Machine	Máquina Virtual de Ethereum	EVM	A runtime environment on the Ethereum blockchain where smart contracts are executed.
European Patent Office	Oficina Europea de Patentes	EPO	The patent office responsible for the granting of European patents, providing a unified patent grant procedure for multiple countries in Europe.
Financial technology	Tecnología financiera	Fintech	Technology that aims to improve and automate the delivery and use of financial services, including mobile banking, cryptocurrency, and online lending platforms.
Fungible Token	Testigo Fungible	FT	A type of digital asset or token that is interchangeable with another unit of the same value, such as cryptocurrencies.

Analysis of Non-Fungible Tokens (NFTs) from an Industrial Property perspective.

Gas fee	Comisión de gas	N/A	A fee paid in cryptocurrency to miners or validators to process and verify transactions on a blockchain network.
Intellectual Property	Propiedad Intelectual	IP	Creations of the mind, such as inventions, literary and artistic works, designs, and symbols, that are protected by law to grant exclusive rights to their creators.
InterPlanetary File System	Sistema de Archivos Interplanetario	IPFS	A decentralized and distributed file storage system that uses content-addressable hyperlinks to store and retrieve data.
Net present value	Valor Neto Actual	NPV	A financial metric used to determine the profitability of an investment or project by comparing the present value of future cash flows to the initial investment.
Non-Disclosure Agreement	Acuerdo de confidencialidad	NDA	A legal contract that establishes a confidential relationship between parties, preventing the disclosure of confidential information to third parties.
Non-Fungible Token	Testigo No Fungible	NFT	A unique digital asset that represents ownership of a specific item, artwork, or digital content on a blockchain, making it indivisible and distinguishable from other tokens.
Off chain	Fuera de la red	N/A	Refers to activities or transactions that occur outside the blockchain, typically involving intermediary platforms or centralized systems.
On-chain	En la red	N/A	Refers to activities or transactions that occur directly on the blockchain, recorded and verified by the network's nodes.

Analysis of Non-Fungible Tokens (NFTs) from an Industrial Property perspective.

Patent Cooperation Treaty	Tratado de Cooperación en materia de Patentes	PCT	An international treaty that enables applicants to file a single international patent application that is recognized by multiple countries.
Peer-to-peer	Sin intermediarios	P2P	A decentralized communication model where computers or devices directly connect and interact with each other without the need for a central server.
Prove of Stake	Prueba de Participación	PoS	A consensus mechanism in blockchain networks where validators are chosen to create new blocks based on the number of coins they hold and are willing to "stake" as collateral.
Prove of Work	Prueba de Trabajo	PoW	A consensus mechanism in blockchain networks where miners compete to solve complex mathematical puzzles to validate transactions and add new blocks to the chain.
Report on the State of the Art	Informe del Estado del Arte	RSA	A detailed analysis and review of existing knowledge, technologies, and developments in a particular field or subject.
Self-sovereign identity	Identidad autosoverana	SSI	A digital identity model that enables individuals to have control and ownership of their personal data, allowing them to share it securely and selectively.
Smart Contract	Contrato inteligente	SC	Self-executing contracts with predefined rules and conditions written in code that automatically execute when certain conditions are met.

Analysis of Non-Fungible Tokens (NFTs) from an Industrial Property perspective.

Spanish Patent and Trademark Office	Oficina Española de Patentes y Marcas	OEPM	The government agency responsible for granting patents and registering trademarks in Spain.
Sustainable Development Goals	Objetivos de Desarrollo Sostenible	SDG	A set of 17 global goals established by the United Nations to address various social, economic, and environmental challenges and promote sustainable development worldwide.
Uniform Resource Identifier	Identificador de Recurso Uniforme	URI	A string of characters used to identify and access resources on the internet or a network.
US Patent and Trademark Office	Oficina de Patentes y Marcas de los Estados Unidos	USPTO	The government agency responsible for granting patents and registering trademarks in the United States.
World Intellectual Property Organization	Organización Mundial de la Propiedad Intelectual	WIPO	A specialized agency of the United Nations that promotes and protects intellectual property rights worldwide.

## 9. Annex I: Code

### 9.1 PatenteNFT.sol

```
// SPDX-License-Identifier: UNLICENSED
pragma solidity ^0.8.0;

import
"@openzeppelin/contracts/token/ERC721/extensions/ERC721Enumerable.sol";
import "@openzeppelin/contracts/access/Ownable.sol";
import "@openzeppelin/contracts/utils/Strings.sol";

contract PatenteNFT is Ownable, ERC721Enumerable {

    using Strings for uint256;

    // Events
    event NewPatentIssued(uint256 indexed tokenId, uint256 timestamp,
address inventor);
    event NewAuthority(address authority);
    event RevokedAuthority(address authority);
    event RegistrationFeePayment(address indexed payer, uint8 feeId);
    event NewPatentOnSale(uint256 indexed tokenId, uint256 salePrice);
    event PatentSold(uint256 indexed tokenId, address buyer, address
seller, uint256 price);

    // Possible patent status values
    enum STATUS { ACTIVE, EXPIRED }

    // Structure patent data
    struct Patent {
        string title;
        uint256 patentNum;
        uint256 timestamp;
        STATUS status;
        address inventor; //It does not change, there can only be one
inventor
        uint256 royalties; //Sets them in inventor, they do not change
        address issuer; //Authorized entity
        uint256 salePrice; // 0 -> Not for sale // != 0 -> For sale
        uint256 activePeriod; //20 years
        uint256 totalFees; // Total registration fees
    }

    // Structure of registration fees
    struct RegistrationFees {
        uint256 fee_1;
        uint256 fee_2;
        uint256 fee_3;
    }

    // Registration fee checks
    struct FeePayment {
        bool fee_1;
        bool fee_2;
    }
}
```

```
    bool fee_3;
}

// Maps tokenIDs to patent data
mapping(uint256 => Patent) private _patentData;

// Maps addresses to fee payment status
mapping(address => FeePayment) private _feesPaid;

// Maps addresses to their total amount of fees paid
mapping(address => uint256) private _totalFeesByAddress;

// Maps addresses to (un)authorized entities
mapping(address => bool) private _authorities;

// Registration fee object creation
RegistrationFees private _registrationFees;

// Base URI for token metadata
string private _BaseURI;

constructor(
    string memory _name_,
    string memory _symbol_,
    string memory _baseURI_)
    ERC721(_name_, _symbol_)
{
    // Contract owner role is set at contract deployment (Ownable.sol)

    // Set the owner as an authorized entity
    _authorities[owner()] = true;

    // Token metadata setting
    _BaseURI = _baseURI_;

    // Assign registration fees
    _registrationFees fee_1 = 300;
    _registrationFees fee_2 = 200;
    _registrationFees fee_3 = 100;
}

/** @notice Modifier - Checks if an address has paid the registration
fees
 * @dev Reverts in case 'candidate' has not paid registration fees
 * @param candidate Checked address
 */
modifier onlyPaid(address candidate) {
    require(_feesPaid[candidate].fee_1, "ERROR: The beneficiary address
has not paid registration fee #1");
    require(_feesPaid[candidate].fee_2, "ERROR: The beneficiary address
has not paid registration fee #2");
    require(_feesPaid[candidate].fee_3, "ERROR: The beneficiary address
has not paid registration fee #3");
    _;
}
```

```

    }

    /** @notice Modifier - Checks if an address is an authorized entity
     * @dev Reverts in case 'candidate' is not an authorized entity
     * @param candidate Checked address
     */
    modifier isAuthority(address candidate) {
        require(_authorities[candidate], "ERROR: Caller must be an
authorized entity");
    }

    /** @notice GET Function - Reads registration fees
     * @return RegistrationFees The value for all registration fees
     */
    function getRegistrationFees() public view returns(RegistrationFees
memory) {
        return _registrationFees;
    }

    /** @notice GET Function - Reads the patent data of a given tokenId
     * @param tokenId Unique identifier for each patent token
     * @return Patent The patent data
     */
    function getPatentById(uint256 tokenId) public view returns(Patent
memory) {
        return _patentData[tokenId];
    }

    /** @notice GET Function - Reads if an address has paid the registration
fees
     * @param addr Queried address
     * @return bool 'true' if 'addr' has paid fees, otherwise 'false'
     */
    function isFeePaid(address addr) public view returns(FeePayment memory)
{
        return _feesPaid[addr];
    }

    /** @notice GET Function - Constructs and returns the URI for token
with ID tokenId
     * @dev It assumes token metadata is stored in JSON format
     * @param tokenId Unique token identifier
     * @return string The complete URI for the queried token
     */
    function tokenURI(uint256 tokenId) public view override returns(string
memory) {
        _requireMinted(tokenId);

        string memory baseURI = _baseURI();
        return bytes(baseURI).length > 0 ? string(abi.encodePacked(baseURI,
tokenId.toString(), ".json")) : "";
    }

```

```
/** @notice GET Function (internal use) - Returns the metadata base URI
 * @return string The base URI for all tokens
 */
function _baseURI() internal view override returns(string memory) {
    return _BaseURI;
}

/** @notice SET Function - Sets a new authorized entity
 * @dev Only the smart contract admin can manage authorities
 * @param newAuthority New authorized entity in the contract
 */
function setAuthority(address newAuthority) public onlyOwner {
    _authorities[newAuthority] = true;
}

/** @notice SET Function - Revokes an authorized entity
 * @dev Only the smart contract admin can manage authorities
 * @param revokedAuthority Address of the revoked authority
 */
function revokeAuthority(address revokedAuthority) public onlyOwner {
    require(_authorities[revokedAuthority], "ERROR: The address is not
an authorized entity");
    _authorities[revokedAuthority] = false;
}

/** @notice SET Function - Sets new values for registration fees
 * @dev Only the smart contract admin can manage registration fees
 * @param _fee1 First registration fee
 * @param _fee2 Second registration fee
 * @param _fee3 Third registration fee
 */
function updateRegistrationFees(uint256 _fee1, uint256 _fee2, uint256
_fee3) public onlyOwner {
    _registrationFees fee_1 = _fee1;
    _registrationFees fee_2 = _fee2;
    _registrationFees fee_3 = _fee3;
}

/** @notice SET Function - Sets a new base URI for token metadata
storage
 * @dev Only the smart contract admin can modify the base URI
 * @param newBaseURI The updated baseURI for metadata storage
 */
function updateBaseURI(string memory newBaseURI) public onlyOwner {
    _BaseURI = newBaseURI;
}

/** @notice Function - Allows authorized entities to issue new patents
 * @dev Reverts if
 * - The caller is not an authorized entity or
```



```
* - The beneficiary of the patent ('inventor') has not paid the fees
* timestamp, status, patentNum and issuer are established at the
moment of issuance
* @param _title The title of the patent
* @param _inventor The address of the inventor
* @param _activePeriod The period of time for which the patent remains
active
*/
function issuePatent(string memory _title, address _inventor, uint256
_activePeriod) public onlyPaid(_inventor) isAuthority(_msgSender())
{
    uint256 supplyBefore = totalSupply();

    _safeMint(_inventor, supplyBefore + 1);

    uint256 supplyAfter = totalSupply(); // = token ID

    // Establish patent data
    _patentData[supplyAfter].title = _title;
    _patentData[supplyAfter].patentNum = supplyAfter;
    _patentData[supplyAfter].timestamp = block.timestamp;
    _patentData[supplyAfter].status = STATUS_ACTIVE;
    _patentData[supplyAfter].inventor = _inventor;
    _patentData[supplyAfter].royalties = 0;
    _patentData[supplyAfter].issuer = _msgSender();
    _patentData[supplyAfter].salePrice = 0;
    _patentData[supplyAfter].activePeriod = _activePeriod;
    _patentData[supplyAfter].totalFees_totalFeesByAddress[_inventor];

    // Clean all fees, to enable the inventor to register additional
future patents and free storage
    _feesPaid[_inventor].fee_1 = false;
    _feesPaid[_inventor].fee_2 = false;
    _feesPaid[_inventor].fee_3 = false;

    _totalFeesByAddress[_inventor] = 0;
}

/** @notice SET Function - Allows users to pay registration fees, as
part as the patent registration process
* @dev Reverts if:
* - The transaction value is inferior to the value of the
registration fee number 'feeId' or
* - The transaction sender has not paid one or more of the previous
registration fees or
* - The registration fee with feeId was already paid or
* - The 'feeId' passed does not exist
* @param feeId The number of the registration fee to be paid
*/
function payRegistrationFees(uint256 feeId) public payable {
    address caller = _msgSender();
    if(feeId == 1) {
        require(
            msg.value == _registrationFees.fee_1,
```

```
        "ERROR: Transaction value not equal to registration fee #1"
    );
    require(
        !_feesPaid[caller].fee_1,
        "ERROR: Registration fee #1 already paid by the calling
address"
    );
    _feesPaid[caller].fee_1 = true;
    _totalFeesByAddress[caller] += _registrationFees.fee_1;
} else if (feeId == 2) {
    require(
        !_feesPaid[caller].fee_1,
        "ERROR: Registration fee #1 is still pending"
    );
    require(
        !_feesPaid[caller].fee_2,
        "ERROR: Registration fee #2 already paid by the calling
address"
    );
    require(
        msg.value == _registrationFees.fee_2,
        "ERROR: Transaction value not equal to registration fee #2"
    );
    _feesPaid[caller].fee_2 = true;
    _totalFeesByAddress[caller] += _registrationFees.fee_2;
} else if (feeId == 3) {
    require(
        !_feesPaid[caller].fee_2,
        "ERROR: Registration fee #2 is still pending"
    );
    require(
        !_feesPaid[caller].fee_3,
        "ERROR: Registration fee #3 already paid by the calling
address"
    );
    require(
        msg.value == _registrationFees.fee_3,
        "ERROR: Transaction value not equal to registration fee #3"
    );
    _feesPaid[caller].fee_3 = true;
    _totalFeesByAddress[caller] += _registrationFees.fee_3;
} else {
    revert();
}
}

/** @notice SET Function - Allows patent owners to set royalties for
their patents
* @dev Royalties are set on basis points for development purposes.
* Examples: _royalties = 500 bps -> 5%
*           _royalties = 2,000 bps -> 20%
* Reverts if:
* - The caller is not the inventor of the patent
```

## Analysis of Non-Fungible Tokens (NFTs) from an Industrial Property perspective.

```
* - The caller is not the actual owner of the tokenId
* - The input _royalties is not within the admissible range
* @dev Notice that only when the inventor is also the owner of the
patent, can the royalties
* be set. Once the patent is sold, the royalties will remain constant
forever.
* @param tokenId The unique identifier of the token
* @param _royalties The value of the royalties in a 0 - 10,000 scale
*/
function setRoyalties(uint256 tokenId, uint256 _royalties) public {
    require(_msgSender() == _patentData[tokenId].inventor, "ERROR: Only
the patent inventor can set royalties");
    require(_msgSender() == _ownerOf(tokenId), "ERROR: The caller must
be the owner of the tokenId");
    require(_royalties >= 0 && _royalties < 10000, "ERROR: Invalid
value for royalties");

    _patentData[tokenId].royalties = _royalties;
}

/** @notice SET Function - Allows users to set a sale price for their
patents
* @dev Reverts if:
* - The patent is no longer active
* - The caller is not the actual owner of the tokenId
* @param priceSale The sale price of patent with tokenId
* @param tokenId The unique identifier of the patent
*/
function setSalePrice(uint256 priceSale, uint256 tokenId) public {
    require(!_isNotExpired(tokenId), "ERROR: This patent is no longer
active and cannot be sold");
    require(_msgSender() == _ownerOf(tokenId), "ERROR: The caller must
be the owner of the tokenId");

    _patentData[tokenId].salePrice = priceSale;
}

/** @notice SET Function -
* @dev Reverts if:
* - The patent is no longer active
* - The patent is not for sale
* -
* @dev The owner of the sold tokenId must have approved this contract
in order to enable automatic transfers
* @param tokenId The unique identifier of the patent
*/
function buyPatent(uint256 tokenId, address addrBuyer) public payable
{
    require(!_isNotExpired(tokenId), "ERROR: This patent is no longer
active and cannot be sold");
    require(_patentData[tokenId].salePrice > 0, "ERROR: This patent is
not for sale");

    uint256 priceToPay = _patentData[tokenId].salePrice;
    require(msg.value == priceToPay, "ERROR: Insufficient transaction
value. Sale price not matched.");
}
```

```

    // Royalty calculation
    (uint256 royalties, uint256 amountToSeller) =
    _calculateRoyalties(tokenId, priceToPay);
    assert(royalties + amountToSeller == priceToPay);

    address prevOwner = ownerOf(tokenId);
    address inventor = _patentData[tokenId].inventor;

    // Update values before interactions
    _patentData[tokenId].salePrice = 0;

    _safeTransfer(prevOwner, addrBuyer, tokenId, "");

    (bool success_1, ) = payable(prevOwner).call{value:
amountToSeller}("");
    require(success_1, "ERROR: The transaction to the seller failed");

    (bool success_2, ) = payable(inventor).call{value: royalties}("");
    require(success_2, "ERROR: The royalty transaction to the inventor
failed");
}

/** @notice SET Function - Allows contract owner to withdraw funds from
the contract
* @dev Only the contract owner can withdraw funds
*/
function withdrawFunds() public onlyOwner {
    uint256 balance = address(this).balance;
    payable(owner()).transfer(balance);
}

/** @notice SET Function (internal use) - Checks if a patent is still
active and modifies the status in case it is not
* @dev This function is called from public functions that have a
relevant impact on the patent, such as sale and purchase
* @param tokenId The unique identifier of the patent
* @return bool 'true' if the patent is still active, 'false' otherwise
*/
function _isNotExpired(uint256 tokenId) internal returns(bool) {
    uint256 currentTime = block.timestamp;
    if(_patentData[tokenId].timestamp +
_patentData[tokenId].activePeriod > currentTime) {
        return true;
    } else {
        _patentData[tokenId].status = STATUS.EXPIRED;
        return false;
    }
}

/** @notice GET Function (internal use) - Calculates the royalties
given the tokenId patent data and the sale price
* @dev Royalties are expressed in basis points, the result is divided
by 10,000

```

Analysis of Non-Fungible Tokens (NFTs) from an Industrial Property perspective.

```
* @param tokenId The unique identifier of the patent
* @param price The sale price of the tokenId
* @return uint256 The amount in royalties to be paid to the inventor
* @return uint256 The amount to be paid to the seller
*/
function _calculateRoyalties(uint256 tokenId, uint256 price) internal
view returns(uint256, uint256) {
    uint256 royalties = (_patentData[tokenId].royalties * price) /
10000;
    uint256 profitSeller = price - royalties;

    return (royalties, profitSeller);
}
}
```

## 9.2 Owner.sol

```
// SPDX-License-Identifier: GPL-3.0

pragma solidity >=0.7.0 <0.9.0;

import "hardhat/console.sol";

/**
 * @title Owner
 * @dev Set & change owner
 */
contract Owner {
    address private owner;

    // event for EVM logging
    event OwnerSet(address indexed oldOwner, address indexed newOwner);

    // modifier to check if caller is owner
    modifier isOwner() {
        // If the first argument of 'require' evaluates to 'false', execution
        terminates and all
        // changes to the state and to Ether balances are reverted.
        // This used to consume all gas in old EVM versions, but not
        anymore.
        // It is often a good idea to use 'require' to check if functions
        are called correctly.
        // As a second argument, you can also provide an explanation about
        what went wrong.
        require(msg.sender == owner, "Caller is not owner");
        _;
    }

    /**
     * @dev Set contract deployer as owner
     */
    constructor() {
        console.log("Owner contract deployed by:", msg.sender);
        owner = msg.sender; // 'msg.sender' is sender of current call,
        contract deployer for a constructor
    }
}
```

```
        emit OwnerSet(address(0), owner);
    }

    /**
     * @dev Change owner
     * @param newOwner address of new owner
     */
    function changeOwner(address newOwner) public isOwner {
        emit OwnerSet(owner, newOwner);
        owner = newOwner;
    }

    /**
     * @dev Return owner address
     * @return address of owner
     */
    function getOwner() external view returns (address) {
        return owner;
    }
}
```

### 9.3 ERC721Enumerable.sol

```
// SPDX-License-Identifier: MIT
//      OpenZeppelin      Contracts      (last      updated      v4.8.0)
(token/ERC721/extensions/ERC721Enumerable.sol)

pragma solidity ^0.8.0;

import "../ERC721.sol";
import "./IERC721Enumerable.sol";

/**
 * @dev This implements an optional extension of {ERC721} defined in the
 EIP that adds
 * enumerability of all the token ids in the contract as well as all token
 ids owned by each
 * account.
 */
abstract contract ERC721Enumerable is ERC721, IERC721Enumerable {
    // Mapping from owner to list of owned token IDs
    mapping(address => mapping(uint256 => uint256)) private _ownedTokens;

    // Mapping from token ID to index of the owner tokens list
    mapping(uint256 => uint256) private _ownedTokensIndex;

    // Array with all token ids, used for enumeration
    uint256[] private _allTokens;

    // Mapping from token id to position in the allTokens array
    mapping(uint256 => uint256) private _allTokensIndex;

    /**
     * @dev See {IERC165-supportsInterface}.
     */
}
```

```
function supportsInterface(bytes4 interfaceId) public view virtual
override(IERC165, ERC721) returns (bool) {
    return interfaceId == type(ERC721Enumerable).interfaceId ||
    super.supportsInterface(interfaceId);
}

/**
 * @dev See {IERC721Enumerable-tokenOfOwnerByIndex}.
 */
function tokenOfOwnerByIndex(address owner, uint256 index) public view
virtual override returns (uint256) {
    require(index < ERC721.balanceOf(owner), "ERC721Enumerable: owner
index out of bounds");
    return _ownedTokens[owner][index];
}

/**
 * @dev See {IERC721Enumerable-totalSupply}.
 */
function totalSupply() public view virtual override returns (uint256)
{
    return _allTokens.length;
}

/**
 * @dev See {IERC721Enumerable-tokenByIndex}.
 */
function tokenByIndex(uint256 index) public view virtual override
returns (uint256) {
    require(index < ERC721Enumerable.totalSupply(), "ERC721Enumerable:
global index out of bounds");
    return _allTokens[index];
}

/**
 * @dev See {ERC721-_beforeTokenTransfer}.
 */
function _beforeTokenTransfer(
    address from,
    address to,
    uint256 firstTokenId,
    uint256 batchSize
) internal virtual override {
    super._beforeTokenTransfer(from, to, firstTokenId, batchSize);

    if (batchSize > 1) {
        // Will only trigger during construction. Batch transferring
(minting) is not available afterwards.
        revert("ERC721Enumerable: consecutive transfers not supported");
    }

    uint256 tokenId = firstTokenId;

    if (from == address(0)) {
        _addTokenToAllTokensEnumeration(tokenId);
    } else if (from != to) {
```

```

        _removeTokenFromOwnerEnumeration(from, tokenId);
    }
    if (to == address(0)) {
        _removeTokenFromAllTokensEnumeration(tokenId);
    } else if (to != from) {
        _addTokenToOwnerEnumeration(to, tokenId);
    }
}

/**
 * @dev Private function to add a token to this extension's ownership-
tracking data structures.
 * @param to address representing the new owner of the given token ID
 * @param tokenId uint256 ID of the token to be added to the tokens
list of the given address
 */
function _addTokenToOwnerEnumeration(address to, uint256 tokenId)
private {
    uint256 length = ERC721.balanceOf(to);
    _ownedTokens[to][length] = tokenId;
    _ownedTokensIndex[tokenId] = length;
}

/**
 * @dev Private function to add a token to this extension's token
tracking data structures.
 * @param tokenId uint256 ID of the token to be added to the tokens
list
 */
function _addTokenToAllTokensEnumeration(uint256 tokenId) private {
    _allTokensIndex[tokenId] = _allTokens.length;
    _allTokens.push(tokenId);
}

/**
 * @dev Private function to remove a token from this extension's
ownership-tracking data structures. Note that
 * while the token is not assigned a new owner, the `_ownedTokensIndex`
mapping is not updated: this allows for
 * gas optimizations e.g. when performing a transfer operation (avoiding
double writes).
 * This has O(1) time complexity, but alters the order of the
_ownedTokens array.
 * @param from address representing the previous owner of the given
token ID
 * @param tokenId uint256 ID of the token to be removed from the tokens
list of the given address
 */
function _removeTokenFromOwnerEnumeration(address from, uint256
tokenId) private {
    // To prevent a gap in from's tokens array, we store the last token
in the index of the token to delete, and
    // then delete the last slot (swap and pop).

    uint256 lastTokenIndex = ERC721.balanceOf(from) - 1;
    uint256 tokenIndex = _ownedTokensIndex[tokenId];

```



```

    // When the token to delete is the last token, the swap operation
    is unnecessary
    if (tokenId != lastTokenId) {
        uint256 lastTokenId = _ownedTokens[from][lastTokenIndex];

        _ownedTokens[from][tokenId] = lastTokenId; // Move the last
        token to the slot of the to-delete token
        _ownedTokensIndex[lastTokenId] = tokenId; // Update the
        moved token's index
    }

    // This also deletes the contents at the last position of the array
    delete _ownedTokensIndex[tokenId];
    delete _ownedTokens[from][lastTokenIndex];
}

/**
 * @dev Private function to remove a token from this extension's token
 tracking data structures.
 * This has O(1) time complexity, but alters the order of the _allTokens
 array.
 * @param tokenId uint256 ID of the token to be removed from the tokens
 list
 */
function _removeTokenFromAllTokensEnumeration(uint256 tokenId) private
{
    // To prevent a gap in the tokens array, we store the last token
    in the index of the token to delete, and
    // then delete the last slot (swap and pop).

    uint256 lastTokenIndex = _allTokens.length - 1;
    uint256 tokenIndex = _allTokensIndex[tokenId];

    // When the token to delete is the last token, the swap operation
    is unnecessary. However, since this occurs so
    // rarely (when the last minted token is burnt) that we still do
    the swap here to avoid the gas cost of adding
    // an 'if' statement (like in _removeTokenFromOwnerEnumeration)
    uint256 lastTokenId = _allTokens[lastTokenIndex];

    _allTokens[tokenIndex] = lastTokenId; // Move the last token to the
    slot of the to-delete token
    _allTokensIndex[lastTokenId] = tokenIndex; // Update the moved
    token's index

    // This also deletes the contents at the last position of the array
    delete _allTokensIndex[tokenId];
    _allTokens.pop();
}
}

```

## 9.4 Strings.sol

```
// SPDX-License-Identifier: MIT
// OpenZeppelin Contracts (last updated v4.9.0) (utils/Strings.sol)

pragma solidity ^0.8.0;

import "./math/Math.sol";
import "./math/SignedMath.sol";

/**
 * @dev String operations.
 */
library Strings {
    bytes16 private constant _SYMBOLS = "0123456789abcdef";
    uint8 private constant _ADDRESS_LENGTH = 20;

    /**
     * @dev Converts a `uint256` to its ASCII `string` decimal
     representation.
     */
    function toString(uint256 value) internal pure returns (string memory)
    {
        unchecked {
            uint256 length = Math.log10(value) + 1;
            string memory buffer = new string(length);
            uint256 ptr;
            /// @solidity memory-safe-assembly
            assembly {
                ptr := add(buffer, add(32, length))
            }
            while (true) {
                ptr--;
                /// @solidity memory-safe-assembly
                assembly {
                    mstore8(ptr, byte(mod(value, 10), _SYMBOLS))
                }
                value /= 10;
                if (value == 0) break;
            }
            return buffer;
        }
    }

    /**
     * @dev Converts a `int256` to its ASCII `string` decimal
     representation.
     */
    function toString(int256 value) internal pure returns (string memory)
    {
        return string(abi.encodePacked(value < 0 ? "-" : "",
        toString(SignedMath.abs(value))));
    }
}

/**
```

```
    * @dev Converts a `uint256` to its ASCII `string` hexadecimal
    representation.
    */
    function toHexString(uint256 value) internal pure returns (string
memory) {
        unchecked {
            return toHexString(value, Math.log256(value) + 1);
        }
    }

    /**
    * @dev Converts a `uint256` to its ASCII `string` hexadecimal
    representation with fixed length.
    */
    function toHexString(uint256 value, uint256 length) internal pure
returns (string memory) {
        bytes memory buffer = new bytes(2 * length + 2);
        buffer[0] = "0";
        buffer[1] = "x";
        for (uint256 i = 2 * length + 1; i > 1; --i) {
            buffer[i] = _SYMBOLS[value & 0xf];
            value >>= 4;
        }
        require(value == 0, "Strings: hex length insufficient");
        return string(buffer);
    }

    /**
    * @dev Converts an `address` with fixed length of 20 bytes to its not
    checksummed ASCII `string` hexadecimal representation.
    */
    function toHexString(address addr) internal pure returns (string
memory) {
        return toHexString(uint256(uint160(addr)), _ADDRESS_LENGTH);
    }

    /**
    * @dev Returns true if the two strings are equal.
    */
    function equal(string memory a, string memory b) internal pure returns
(bool) {
        return keccak256(bytes(a)) == keccak256(bytes(b));
    }
}
```

Analysis of Non-Fungible Tokens (NFTs) from an Industrial Property perspective.

## 10. Annex II. Complying with SDG principles

### 10.1 SDG Dimensions

The Sustainable Development Goals (SDGs) are a collection of 17 global goals for sustainable growth by 2030 designed as a blueprint for action towards a more sustainable world for all. These goals are grouped into three major dimensions which are economic growth, social inclusion, and environmental protection. Of all of them, the "Analysis of Non-Fungible Tokens (NFTs) under an Industrial Property perspective" moves mainly in two major dimensions, which are the economic dimension mainly and the environmental to a lesser extent, which are reflected in the following SDGs.

- **7: Affordable and clean energy.** Seeks to ensure access to affordable, safe, sustainable and modern energy for all. To this end, it is necessary to double the global rate of improvement in energy efficiency, as well as substantially increase the percentage of renewables in the energy mix.
- **8: Decent work and economic growth.** Promote sustained, inclusive and sustainable economic growth, full and productive employment and decent work for all.
- **9: Industry, innovation and infrastructure.** Aims to achieve sustainable, resilient and quality infrastructure for all, promote a new industry under sustainability criteria that adopts clean and environmentally sound technologies and industrial processes, foster technology, innovation and research, and achieve equal access to information and knowledge, mainly through the Internet.

### **Economic dimension**

At the economic level, NFTs as patents contribute positively. On the one hand, if we study the impact of NFTs separately, they benefit individuals and companies in the following ways:

1. It offers companies new opportunities to manage and commercialize assets digitally. It allows creators to increase the value of their assets through secondary trading of their assets on the NFT platform.
2. New financing options: through decentralized financing, new forms of access to capital can be accessed in a simplified and democratized way, which helps small businesses.

3. The blockchain technology they employ guarantees the uniqueness and standardization of assets in addition to avoiding their counterfeiting, which makes it a very attractive market for all types of industries [64].

On the other hand, if we study the impact that patents have on the economy, we observe the following benefits:

1. Patents allow the individual or company that owns them to have exclusivity to produce, license or sell a product or procedure created, which minimizes unauthorized replicas or copies in addition to helping to recover the initial investment.
2. Patents encourage innovation and provide prestige and social reputation to their holders, which boosts the economy.
3. Especially for companies, patents are indicators of technological innovation and endorse valuable characteristics such as certified technical advantages over competitors.

Studying therefore the joint effect of patents marketed as NFTs, the main benefit for the IP holder is the fact that he can benefit from their creation not only in the short term, but also in the long term, with the subsequent sale and purchase of the corresponding NFT.

## **Environmental dimension**

In terms of environmental care, NFTs contribute negatively due to the high energy consumption and unsustainable infrastructure that supports this technology. The Blockchain technology used by the NFTs network works thanks to a very extensive network of interconnected computers called nodes that run the software in charge of its operation [1].

In turn, this extensive infrastructure generates a significant electrical expense for each NFT transaction. According to Memo Akten's calculations, "the average NFT has a carbon footprint equivalent to the monthly footprint of a citizen of the European Union" [89], although this data must be verified as the type of energy used to generate this electricity is not specified.

According to WIRED, mining one NFT consumes approximately 35 kWh of electricity and each transaction of NFTs consumes 44.49 TWh, which is what a country considered small consumes annually. Fortunately, there are currently proposals such as Ethereum 2.0 or Layer 2. The first aims to reduce energy consumption by 99.95%, while the second aims to reduce the pollution of the platform from 3,000 Wh to 110 Wh, eventually reaching 11 Wh [89].

Although power consumption and pollution will not decrease in the short term, the industry's major competitors are already taking measures that, together with future new regulations, will contribute to environmental protection.

## **10.2 Why is Ethereum becoming more efficient? PoW vs. PoS**

Proof of Work (PoW) and Proof of Stake (PoS) are two consensus mechanisms used in blockchain networks to validate and secure transactions. PoW is the original consensus mechanism used by Bitcoin and many other cryptocurrencies. It requires participants, known as miners, to solve complex mathematical puzzles in order to validate transactions and create new blocks. This process requires significant computational power and energy consumption. Miners compete against each other, and the one who solves the puzzle first gets the right to add the next block to the blockchain. PoW is considered secure because it requires a substantial amount of computational effort to alter the blockchain's history.

On the other hand, PoS is an alternative consensus mechanism that has gained popularity due to its energy efficiency and reduced environmental impact. In PoS, validators are chosen to create new blocks based on the number of coins they hold and are willing to "stake" as collateral. Rather than solving resource-intensive puzzles, validators are selected randomly, and their chances of being selected are proportional to the number of coins they hold. Validators are incentivized to act honestly because their stakes can be forfeited if they attempt to manipulate the system. This process consumes significantly less energy compared to PoW, as it doesn't rely on extensive computational calculations.

In 2022, Ethereum made an official transition to a Proof of Stake (PoS) consensus mechanism, which serves as a more secure and energy-efficient approach to validating transactions and incorporating new blocks into the blockchain. Some reasons to believe the Ethereum network is becoming more aligned with the ESG principles are provided below:

- **Reduced Energy Consumption:** The transition from PoW to PoS in Ethereum, known as Ethereum 2.0 or ETH2, aims to significantly reduce the network's energy consumption. With PoS, there is no need for miners to compete in solving complex puzzles, leading to a substantial reduction in energy requirements.
- **More Energy-Efficient Validation:** PoS eliminates the need for power-hungry mining rigs, which consume vast amounts of electricity. Validators in PoS networks can participate using regular consumer-grade hardware, requiring only a fraction of the energy consumed by PoW mining equipment.
- **Environmental Benefits:** By consuming less energy, PoS-based Ethereum aligns more closely with Environmental, Social, and Governance (ESG) principles. It addresses concerns related to the carbon footprint and environmental impact associated with PoW mining, making Ethereum a more sustainable blockchain platform.
- **Scalability and Cost Reduction:** The shift to PoS improves the scalability of the Ethereum network, allowing for faster transaction processing and reduced fees. This can facilitate broader adoption and make Ethereum more accessible to users and developers alike.
- **Continued Security:** While PoS introduces a different approach to achieving consensus, it still maintains a high level of security. Validators have economic incentives to act honestly and validate transactions correctly, as their staked assets are at risk. Additionally, Ethereum 2.0 incorporates various mechanisms and penalties to deter malicious behavior and ensure the integrity of the network.

In conclusion, it must be said that the blockchain network as a whole, including Ethereum, is in a state of constant evolution and advancement. This ongoing progress is driven by a collective commitment to developing better solutions that can pave the way for a more promising future. Through initiatives such as the transition to Proof of Stake and the exploration of various technological advancements, the aim is to create a sustainable and inclusive ecosystem that aligns with the needs of our world. As blockchain technology continues to evolve, it holds the potential to revolutionize various industries, promote transparency, and contribute to a better future for all.