



Viability of providing spinning reserves by RES in Spanish island power systems

Mohammad Rajabdorri  | Lukas Sigrist  | Enrique Lobato | Maria del Carmen Prats |
Francisco M. Echavarren

IIT, School of Engineering ICAI, Universidad Pontificia Comillas, Madrid, Spain

Correspondence

Mohammad Rajabdorri, IIT, School of Engineering ICAI, Universidad Pontificia Comillas, Madrid, Spain.
Email: mrajabdorri@comillas.edu

Abstract

This paper assesses the viability of providing down and up spinning reserves by renewable energy resources (RES) in island power systems. The process consists of evaluating the impact of providing spinning reserve on the system operation costs of different islands by simulating the unit commitment problem. The assessment is carried out for La Palma (small size) and Tenerife (medium size) island power systems, and by considering different wind source availability scenarios for sample weeks of different seasons in current and future years. This paper differentiates between up and down reserves and studies their impacts separately. Results show that enabling RES to provide just down spinning reserve has economic benefits for all scenarios, by reducing over 40% the amount of thermal generation and over 30% the systems costs for high wind scenarios. It also confirms that employing variable deloading of wind energy as a source of up reserve is advisable, mainly in scenarios with high share of wind sources. In some scenarios, using RES as reserve provider, reduces the amount of thermal generation more than 50%, compared to when RES does not participate as a source of reserve, and can even lead to a full RES coverage of demand.

1 | INTRODUCTION

Islands are facing considerable challenges in meeting their energy needs in a sustainable, affordable and reliable way. This is mainly due to the isolated nature and the small size of island power systems. The geographic isolation also causes relatively high operation costs in comparison to large interconnected systems. Operation costs are not only higher because of expensive fuel transportation and lower efficiencies of the power generation technologies (e.g. Diesel), but also because of technical spinning reserve requirements to guarantee frequency stability. Actually, island power systems are more prone to suffer from frequency instability than larger interconnected systems, since they poses a smaller inertia and each generating unit represents a significant fraction of the total generation in-feed [1].

According to local resource availability, renewable energy sources (RES) offer an interesting solution to decrease the

dependency on fossil fuels and increase island sustainability [2]. In [3], the possibility of achieving 100% renewable generation in Canary Islands before 2050 is investigated. [4,5] determine the potential of off-shore wind generation and solar PV rooftop installations in the Canary Islands. In current practice by operators, all available RES generation is directly injected to the power system, substituting thermal generation [6]. However, the increasing penetration of RES can negatively affect frequency stability of island power systems even further [7,8], by reducing control capacity and system inertia.

Spinning reserves denote the sufficient power and energy reserves to contribute to frequency stability. Spinning reserves in power systems should be able to cover both emergency and non-emergency conditions. Nonemergency incidents include expected RES fluctuations (wind and solar forecast error) or the demand variations (demand forecast error). And emergency incidents include for instance the loss of generation units in case of generator trips or transmission line outages [9].

This is an open access article under the terms of the [Creative Commons Attribution](https://creativecommons.org/licenses/by/4.0/) License, which permits use, distribution and reproduction in any medium, provided the original work is properly cited.

© 2021 The Authors. *IET Renewable Power Generation* published by John Wiley & Sons Ltd on behalf of The Institution of Engineering and Technology

By increasing the injection of uncertain renewable power into the system, more reserve is required to balance the forecasted generation and real time demands, hence an adequate sizing of the reserve is essential [10]. Refs. [11,12] study the provision of reserve margins to hedge against real-time uncertainty and variability of wind power generation. The impact of forecasting horizon and amount of RES generation on reserve requirements has been analysed in [13]. However, RES does not provide spinning reserves so far in Spanish island systems. RES generation can be curtailed to ensure system stability, when over-generation is about to happen.

When RES provides no spinning reserves, there should be some thermal generation above minimum power to serve as down reserve and same or different thermal units should keep some headroom below maximum power to serve as up reserve. Thus, RES providing down and up reserve can change the commitment status of units to reduce the operation costs. Since enabling RES to provide up reserve is completely different with enabling them to provide down reserve and they change the commitment status differently, they should be studied separately. As far as the authors' knowledge, this hasn't been done in previous studies.

Synchronous generators have always been the main providers of inertia and frequency regulation in the power system. Non-synchronous RES are unable to increase the inertia of the system unless appropriate controls are in place, because the converters decouple them from the grid [14]. Researchers have been trying to find ways of enabling wind turbines to contribute in primary frequency regulation and deliver inertia to the system. In [15], various reserve allocation methods are compared and a practice to assess immediate wind primary reserve is presented. Ref. [16] has tested various control strategies of active power to investigate their effectiveness in times of high wind injection. It concludes that inertial and power frequency response controllers can be implemented on wind turbine generators and enhance the overall frequency response of the system. In [17] an aggregated frequency response model for wind generators is presented, considering the different operational modes of wind power turbines. Then an analytical approach is employed to aggregate low-order frequency response model of all wind power plants into one model. In [18] a stochastic unit commitment formulation is proposed, to evaluate the advantages of synthetic inertia and primary frequency response provision from wind turbines in Great Britain power system and concludes that it potentially can mitigate operation costs of the system. Ref. [19] has mentioned some inertia and frequency regulation approaches for RES: Deloading techniques, inertia emulation, fast power reserve, and droop techniques.

Among them, deloading brings more economic and technical benefits and provides a better frequency response [20]. Although deloading practice enables wind turbines to take part in frequency regulations, it contradicts with the principle of acquiring the highest possible amount of power from wind source [21]. RES such as wind power or solar generation are technically able to provide reserves by deloading a percentage of their maximum power point tracking (MPPT) operation [22]. This can be achieved by appropriately adjusting rotor speed in

wind turbines or the DC-link voltage in photo voltaic systems. Typically, deloading rate is less than 20% of the actual available RES power, depending on the circumstances [23]. An extensive review on deloading of wind turbines in power systems is presented in [24], and different control modes are compared. A stable operation of wind turbine generators is introduced in [25], which guarantees the optimum contribution of each wind turbine to improve the primary frequency response of the system. A dynamic strategy of active power control is presented in [26], to maximize the role of variable speed wind turbine in primary frequency regulation. The authors employ a fuzzy control method to sense the frequency deviations and adjust the amount of deloading subsequently. In [27], the authors argue that existing linear deloading techniques lack accuracy, and the nonlinear relation between rotor speed and output power during deloading practice should not be overlooked. Then they've proposed a nonlinear formulation to enhance stability and frequency regulation participation of wind turbines in micro grid. The reviewed literature is summarised in Figure 1. They've been classified depending on their issues. The ones that are particularly related to islands are highlighted with dashed lines. Those that are applied to real systems are specified with double arrows.

According to the Canary Islands Energy Yearbook of 2018 [28], there's been 9282.8 GWh of annual energy production, consisted of around 10% renewable generation, 90% thermal generation and less than 0.01% refinery and cogeneration in 2018. Only in 2018, the amount of 1819.8 kilotonnes of fuel (including gasoil, diesel oil and fuel oil) has been imported to Canary Islands, for the purpose of electricity generation. They're planning to add 200% to the renewable resources by 2025, and add 400% renewable capacity by 2030. Under such scenarios, the question arises whether reserve should be still provided by synchronous generators only or whether non-synchronous RES should participate as well. For this purpose, the islands of Tenerife (medium size) and La Palma (small scale) are chosen for simulations because they are representative for the Spanish isolated systems. Further, the results shown here can be extrapolated to other islands to a good extent, since these two islands seem to fit in two of the five prototypes islands identified through clustering techniques in [29]. The main objective of this paper is to evaluate the contribution of providing up and down spinning reserves by RES generation. The assessment consists of determining the impact of providing spinning reserve on the system operation costs by simulating its economic operation. As most island systems are operated under a classical centralized scheme, hourly unit commitment (UC) on a weekly basis is proposed for this purpose. The focus is on analysing whether reserve provision by RES generation is beneficial, whereas the actual implementation of the corresponding operation planning is out of scope. The actual implementation is affected by the variability of RES and might require operation planning methodologies under uncertainty, but to highlight the economic aspects of providing reserve by RES, a deterministic approach considering different scenarios (seasons and years) would be sufficient. To contribute to the previous publications, the methodology of this paper is applied to two real islands, La Palma and Tenerife, with factual input data. Four different

RES integration in islands	RES on frequency stability
RES providing frequency response	Deloading in RES
Reserve requirement	

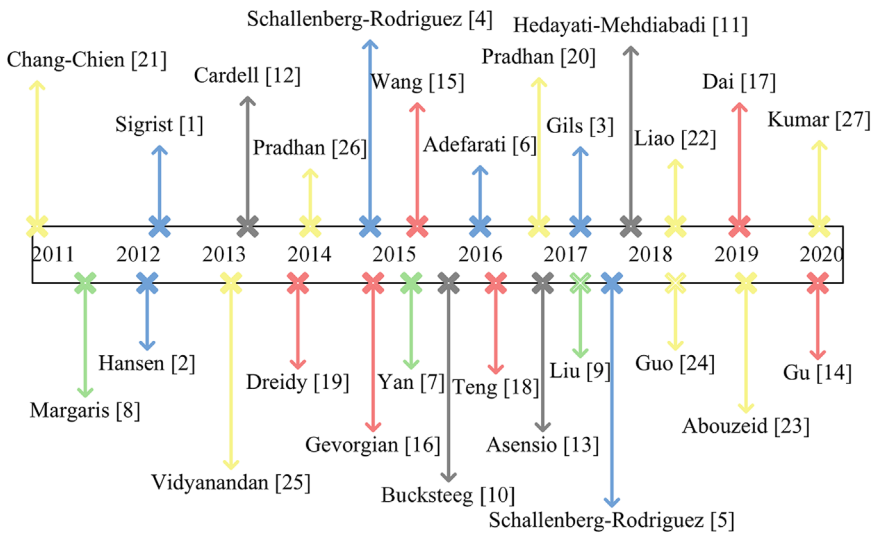

FIGURE 1 A summary of the reviewed literature. Those that are applied to real systems are specified with double arrows

approaches of reserve provision are considered (RES providing no reserve, RES providing only down reserve, RES providing up and down reserve with a fixed constant deloading factor and RES providing up and down reserve with a dynamic optimum deloading factor) are considered as different cases and are applied on various seasonal scenarios (summer, autumn, winter and spring), both for current and future timeframes (years 2020, 2025 and 2030). Up reserve and down reserve are formulated and analysed separately, then the impacts of each on the operation cost is included. Deloading is defined as a variable in UC problem, and the amount of deloading is optimized for each hour in the last approach of RES reserve provision. A total number of 240 UC weekly simulations are performed for each island. Note that this paper tackles the economic benefits of RES up and down reserve provision. The technical benefits of reserve provision on the dynamic frequency response performance will be analysed in future research. However, the non-synchronous RES can deploy reserve faster than conventional synchronous generators.

The rest of the paper is organized as follows. Section 2 summarises the regulations of Spanish isolated systems. Then in Section 3, the methodology used in this paper is explained. In Section 4, the unit commitment formulation of the optimization problem is introduced and the corresponding constraints are presented. In Section 5, the obtained results for both islands are fully analysed. Conclusions are drawn in Section 6 and after that acknowledgments, nomenclature, and references are presented.

2 | REVIEW OF THE REGULATION OF SPANISH ISOLATED POWER SYSTEMS

This section provides a short review of the regulation of Spanish isolated power systems [30]. The Spanish isolated power

systems are the power systems of the Canary Islands, Balearic Islands and the Spanish towns in North Africa. These systems are of very different sizes. The largest system is Mallorca-Menorca system with a peak demand around 1100 MW and the smallest system is El Hierro system with a peak demand of 7 MW.

2.1 | Reserve requirement

The technical regulatory framework of the Spanish isolated power systems is defined in a set of operational procedures [30]. Among others, the operation procedure number 1 describes the spinning reserve requirements in the isolated Spanish power systems. It points out that the up-spinning reserve, including primary and secondary frequency control reserves, should be greater than the largest online unit, greater than the expected RES power generation variations, and greater than the largest interconnection infeed. In addition, down spinning reserve must be at least 50% of the upward primary reserve. The operational procedure also recognizes that during the outage of a large unit, primary frequency control makes use of both primary and secondary reserves.

2.2 | Economic regulation

Isolated power systems can be operated either under a classical centralized scheme or under a market driven scheme. Spanish isolated power systems are operated under a centralized scheme.

In a classical centralized scheme generating units are programmed according to economic dispatch rules that consider security of supply. Generation program is sequentially

determined over different time horizons: weekly, daily, intraday and real-time. The weekly generation program is initially determined by a UC and security of supply criteria. The UC contemplates standardized variable operation costs. In a second step, technical restrictions of the network are imposed and generation units are re-scheduled if needed. Determination of the daily generation program is similar to the determination of the weekly program.

Generators in Spanish isolated power systems are divided into two categories: category A includes hydro (excluding run of the river) and thermal generators and cogeneration power plants with net power greater than 15 MW, whereas category B refers to renewable energies and cogeneration power plants with a net power equal or lower than 15 MW. Renewable sources and high efficiency cogenerators (of both category A or B) have priority of dispatch under equal economic conditions, considering that the security of supply requirements is maintained [30].

Generators of category A that have been included in the additional remuneration scheme (*regimen retributivo adicional*), are remunerated according to fixed costs and variable generation costs in function of the generation technology. The additional remuneration scheme repays investments and exploitation expenditures. Generators of category A that are not included in this scheme perceive a payment according to the hourly energy selling price and the energy produced. Generators of category B are remunerated according to the hourly energy selling price and the energy produced plus a specific remuneration as well as a payment for their contribution to ancillary services (if any). Note that the hourly energy selling price of the Spanish isolated systems depends on daily or intraday market price of the mainland system weighted by the relation between actual hourly demand and average daily demand of the isolated system of interest.

3 | METHODOLOGY TO ASSESS THE VIABILITY OF PROVIDING SPINNING RESERVES BY RES

This section presents the methodology to assess the viability of providing spinning reserves by RES in island power systems. First, the main benefits behind the provision of spinning reserves by RES are illustrated. Second, an overview of the proposed methodology is given. The assessment is based on the simulation of the economic operation by means of an hourly UC on a weekly basis.

3.1 | Illustration of the benefits of providing reserves by RES

To provide spinning reserves, conventional units are connected and operated below the maximum power generation. The amount of required spinning reserves can be substantial in comparison with the total generation, increasing operation cost significantly. Operation costs could be reduced by providing spinning reserves by RES.

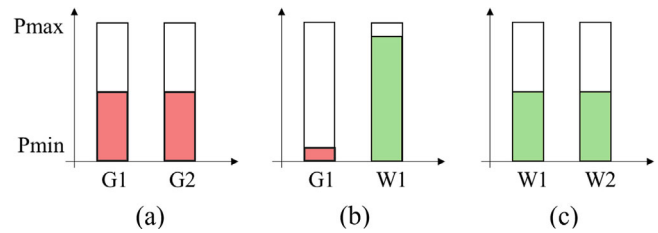

FIGURE 2 Illustration of the benefits of providing spinning reserves by RES: a) Covering demand and providing reserves by G1 and G2, b) Covering demand by W1 and providing reserves by G1, c) Covering demand and providing reserves by W1 and W2

Figure 2 illustrates the main idea and benefits in terms of cost reduction of providing spinning reserves by RES. Suppose a hypothetical power system with two conventional units G1 and G2, and two wind farms, W1 and W2, feeding a certain demand at a given instant. G1, G2, W1, and W2 have the same size in terms of maximum generation at that given instant. In Figure 2(a), the demand is covered by the generation of units G1 and G2, and spinning reserves is also provided by G1 and G2. Note that both units operate at the same power level to cover their possible individual outages. In Figure 2(b), the demand is covered mostly by the wind farm W1 but also by G1, whereas reserve is mostly provided by unit G1. Note that unit G1 operates at the minimum power generation level. In Figure 2(c), the demand is covered by the two wind farms W1 and W2, and spinning reserves are also provided by W1 and W2. Since operation costs of wind farms are usually much lower than those of the conventional generation, it is reasonable to assume that the operation cost decreases from Figure 2(a–c).

Although the example is only illustrative and highly hypothetical, it shows the benefits of providing reserves by RES. It also insinuates that this provision makes sense under high RES penetration scenarios, where the exceeding available RES energy is not simply spilled, but reserved. The difference with respect to spilling is that an appropriate primary frequency controller is required to release the reserved energy.

3.2 | Overview of the methodology

The methodology is based on simulations of the economic operation of islands under different demands, RES penetration scenarios and cases with different approaches of providing reserve. The economic operation is simulated with an hourly UC on a weekly basis. The UC determines the hourly generation set point as well as the hourly start-up and shut-down decisions.

For a given weekly demand profile, the corresponding current RES profiles are scaled up according to the considered future installed capacity. Scaling-up current profiles is a proxy for future profiles under higher penetration scenarios since the current installed RES and RES spillage are low.

For each weekly demand and RES generation profile, the simulation of economic operation is performed, considering whether RES is controllable (the subset of controllable RES is denoted as *eres* in the paper) and able to provide up or down

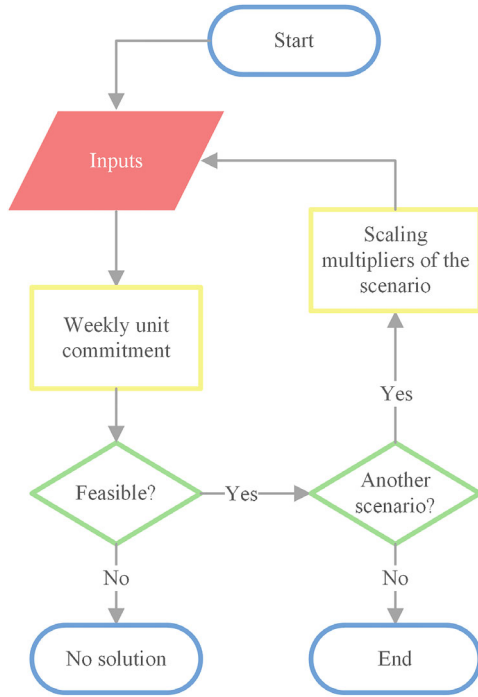

FIGURE 3 Flowchart of the methodology

reserves or not. Different cases are considered which are introduced in results section.

Figure 3 shows a flow chart of the methodology. Input of the weekly unit commitment includes the weekly hourly demand, wind and solar generation forecast, list of thermal generators and their data sheet for each island and each sample week under study. Considered scenarios are further discussed in Section 5.

4 | UC MODEL

The UC is formulated as minimization problem where generation set points and start-up and shut-down decisions are such that the total weekly operation cost is minimized by considering technical constraints. The objective function as well as associated constraints are summarized next. A description of the full UC but without constraints related to reserve provision by RES can be found in [31].

4.1 | Objective function

As stated in [31], the objective is to minimize the total operation costs, by finding the optimum start-up decisions of thermal units and their hourly generation. The objective function is:

$$\min \sum_{t \in \tau} \sum_{i \in I} \left[\left(C_i^{fix} \cdot x_i(t) + C_i^{lin} \cdot p_i(t) + C_i^{qua} \cdot p_i^2(t) + C_i^{start-up} \cdot y_i(t) + C_i^{shut-down} \cdot z_i(t) \right) \right] \quad (1)$$

where quadratic generation cost curves have been approximated by piecewise linear functions.

4.2 | Binary logic

Binary logic of status of thermal units is defined in Equations (2) and (3).

$$x_i(t) - x_i(t-1) = y_i(t) - z_j(t), \quad t \in \tau \quad (2)$$

$$y_i(t) - z_j(t) \leq 1, \quad t \in \tau \quad (3)$$

Minimum up-time and down-time constraints are from [32]. It's further confirmed in other researches like [33], that this approach improves the solving time of UC problem.

4.3 | Constraints

4.3.1 | Demand balance

Concerning demand balance, Equation (1) formulates that the total power generation (thermal units and wind) must be equal to total load demand.

$$\sum_{i \in I} p_i(t) + \sum_{res \in RES} P_{res}(t) - \sum_{dw \in DW} P_{dw}^{downloaded}(t) - \sum_{res \in RES} p_{res}^{spilled}(t) = D(t), \quad t \in \tau \quad (4)$$

Note that $p_{res}^{spilled}(t)$ is the amount of spillage that is scheduled for renewable energy source. $P_{dw}^{downloaded}(t)$ is introduced in the following.

4.3.2 | Thermal technical operation

Concerning thermal technical operation, Equation (5) makes sure that thermal units are generating between their maximum and minimum capability. Equation (6) imposes the ramping limitation. Any increment/decrement of power between two consecutive hours should not exceed generator's ramp up/down limits.

$$\underline{P}_i \cdot x_i(t) \leq p_i(t) \leq \bar{P}_i \cdot x_i(t), \quad \forall i \in I, \forall t \in \tau \quad (5)$$

$$-\underline{R}_i - \bar{P}_i \cdot z_j(t) \leq p_i(t) - p_i(t-1) \leq \bar{R}_i + \bar{P}_i \cdot y(t), \quad \forall i \in I, \forall t \in \tau \quad (6)$$

Binary variables of start-up/shut-down are used in Equation (6), so the units are able to start up/shut down even if $\bar{R}_i/\underline{R}_i$ is smaller than \underline{P}_i .

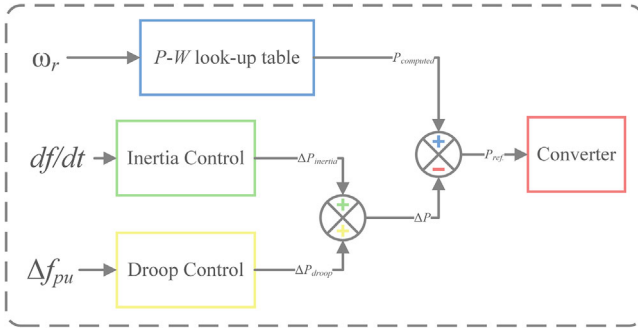

FIGURE 4 General control strategy of the deloaded wind turbine

4.3.3 | Wind power deloading

In maximum power point tracking (MPPT) approach, all available energy is instantly used for generation. But in deloading control mode, a percentage of available energy is stored as reserve to support the system when a contingency happens. The maximum power is reduced by deloading factor in the optimization problem. However, the wind turbine should be controllable (receive set point variations). As an example, a general control strategy is showed in Figure 4 [23]. Reserves are activated through appropriate proportional and derivative frequency controls. Note that this paper does not focus on the details of control strategies, but it tries to study the economic impacts from the operator's perspective.

$$p_{dw}^{deloaded}(t) = P_{dw}(t) \cdot DF(t) \quad \forall t \in \tau, dw \in DW \quad (7)$$

In other words, net RES generation can be reduced by spilling energy with respect to the available wind generation as long as it is controllable. Typically, RES generation under the current scenarios is only spilled in case of possible issues with respect to system stability (like over-generation).

4.3.4 | System reserve requirement

As specified by Spain regulations for isolated systems, up spinning reserve in each hour should be bigger than the maximum of the largest operating unit and the expected RES uncertainty. Also following Spain regulations, total down spinning reserve must be greater than k_{DR} (here 50%) of the up-spinning reserve. Equations (8) and (9) compute the required up and down reserves. k_{RV} is set to 30% in this paper.

$$URR(t) = \max \left\{ \begin{array}{l} \max \{ p_i(t), i \in I \}, \\ \left(\sum_{res \in RES} (P_{res}(t) - P_{res}^{spilled}(t)) \right) - \sum_{dw \in DW} p_{dw}^{deloaded}(t) \end{array} \right\} \cdot k_{RV} \quad (8)$$

$$DRR(t) = URR(t) \cdot k_{DR}, \quad \forall t \in \tau \quad (9)$$

4.3.5 | System reserve provision

Computation of upward and downward primary reserves provided by thermal units are formulated in Equations (10)–(13).

$$r_i^{up}(t) \leq \sum_{i \in I} \left(\bar{P}_i \cdot x_i(t) - p_i(t) \right), \quad \forall t \in \tau \quad (10)$$

$$r_i^{up}(t) \leq \frac{\bar{R}_i}{4}, \quad \forall t \in \tau \quad (11)$$

$$r_i^{down}(t) \leq \sum_{i \in I} \left(p_i(t) - \underline{P}_i \cdot x_i(t) \right), \quad \forall t \in \tau \quad (12)$$

$$r_i^{down}(t) \leq \frac{R_i}{4}, \quad \forall t \in \tau \quad (13)$$

The thermal unit should be able to accomplish active power increase or decrease in 15 min [34]. Equation (10) limits the amount of scheduled reserve to the extent that ramp-up rate of the unit allows (15 min is a quarter of an hour, so the ramp-up rate is divided to 4). Same explanation for ramp-down rate and Equation (12).

Up reserves can be provided by renewable sources if final generation set point is below the available RES power and the proper control mechanism is implemented on them. Wind turbines can participate as up reserve providers, if they benefit from deloading control mechanism. There are different control strategies in the literature (see [23,24,26]), mainly possible by conventional PI controllers and small ROM memories to form the required look-up tables. The cost of adding deloading control mechanism, its tuning and its maintenance is ignored in the cost function. Still the objective function is able to reflect the opportunity cost of providing reserve by deloading wind generation instead of using the associated energy to cover demand. Renewable energy sources can provide down reserve if they are able to sense the frequency of the system and curtail their generation in case of high frequency. Considering the deloading wind turbines and those controllable renewable sources that can participate as down reserve providers, up and down reserve criteria are defined as following.

$$\sum_{i \in I} r_i^{up}(t) + \sum_{cw \in CW} p_{cw}^{deloaded} \geq URR(t), \quad \forall t \in \tau \quad (14)$$

$$\sum_{i \in I} r_i^{down}(t) + \sum_{cres \in CRES} \left(P_{cres}(t) - P_{cres}^{spilled}(t) \right) - \sum_{dw \in DW} p_{dw}^{deloaded}(t) \geq DRR(t) \quad \forall t \in \tau \quad (15)$$

Equations (14) makes sure that the available up spinning reserve which is the summation of reserve provided by thermal units and deloading of wind turbines, meets the requirements. Equation (15) states that the summation of down reserve provided by thermal units and down reserve provided by controllable renewable energy sources, should be higher than required

amount. Note that the deloaded power, is the amount of power that is not extracted from the wind turbine and is kept as the headroom, so in case of any frequency drop it can be extracted. On the other hand, spilled power is scheduled to be curtailed. That can be achieved by stalling some of the wind turbines entirely.

5 | CASE STUDIES

The methodology to assess the viability of providing spinning reserves by wind power generation has been applied to La Palma and Tenerife, both belonging to the Canary Islands. First, a brief description of the features of the island power systems is given. Next, the scenarios of demand and RES generation profiles are presented. Finally, the results of simulating the weekly economic operation for the considered scenarios are shown.

5.1 | Description of the case studies

5.1.1 | La Palma

The yearly demand in 2018 is about 277.8 GWh (average hourly demand of 31.7 MWh), supplied by eleven Diesel generators pre-dominantly. According to [28], the installed capacity of the La Palma island power system mounts to 117.7 MW, where about 6% of the installed capacity belongs to wind power generation. Renewable generation covers about 10% of the yearly demand.

5.1.2 | Tenerife

Total yearly demand in 2018 mounts up to 3,686.2 GWh (average hourly demand of 420.8 MWh). Two combined cycle units (gas and steam), cover around 45.5% of annual demand. Four thermal steam units generate around 35.5% of the annual demand. There are five diesel units that cover 7% of annual demand. Five thermal gas units generate 3.5% of annual electricity demand. The rest is delivered by RES. Operators are planning to decommission some of the more expensive thermal units and add to the renewable capacity before 2025. Figure 5 shows how much power is delivered from 1 unit of wind or solar in different seasons of the year from all RES sites in Tenerife island.

The Energy Strategy for the Canary Islands in 2025 aims to drive the system to a low carbon economy. Among others, strategic objectives for the 2015–2025 period regarding RES involve achieving a 45% of RES participation in final electricity generation by 2025. This would require to multiply the amount of installed RES capacity, at least by five. In case of wind power generation, not only on-shore but also off-shore wind farms are contemplated. In fact, authors in [5] have estimated the wind off-shore potential of the Canary Islands and concluded that 420 MW of off-shore wind power generation can be installed in La Palma, about 40 times the current installed capacity of RES.

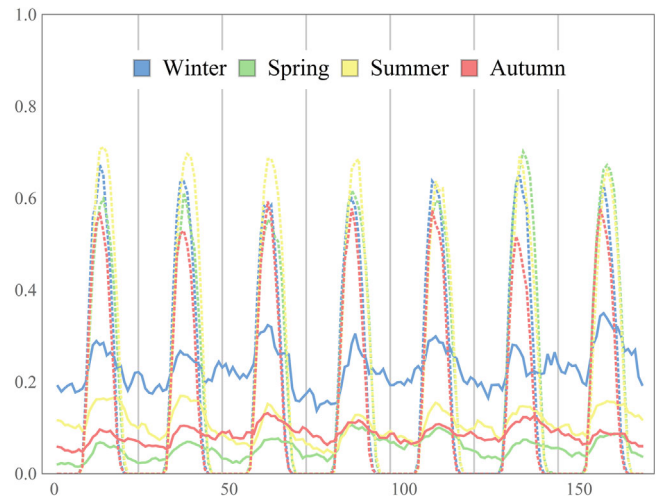

FIGURE 5 Cumulative generation of wind and solar in Tenerife island per unit during weeks of different seasons. Solid lines denote wind generation and dashes denote solar generation

To achieve realistic results, in this study the most recent actual demand and RES generation of Tenerife and La Palma are used as the inputs. For the future cases, the demand is scaled up by forecasted multipliers for the corresponding year. Other required inputs, including available power plants and their technical specifications like cost functions, up and down time limitations, capacities, ramping limitations and etc. are updated real data, obtained from the operators.

5.2 | Scenario definition

The impact of wind penetration levels on providing spinning reserve has been analysed by contemplating different scenarios of increasing installed capacity, in sample weeks of winter, spring, summer and autumn. Scenario I denotes the current amount of installed wind capacity. For scenarios (II)–(V), the initial amount is multiplied by 2, 5, 10 and ∞ , respectively. All the seasons and scenarios are considered for forecasted electricity demand of years 2020, 2025 and 2030 to acknowledge the economic benefits of each scenario in near future.

For each scenario, four cases with different capabilities of providing spinning reserve by RES are defined.

- Case A: This case is the current practice of operators in Spanish islands. RES cannot provide spinning reserve. Both up and down reserves should be provided by thermal units. This case serves as a reference case.
- Case B: renewable sources are able to provide down reserve, but they're unable to offer any up reserve.
- Case C: wind and solar sources provide down spinning reserve. A deloading factor of 10% is applied for the entire time horizon to available wind power. So, in each hour, 10% of available wind generation is deloaded and specified as up reserve.

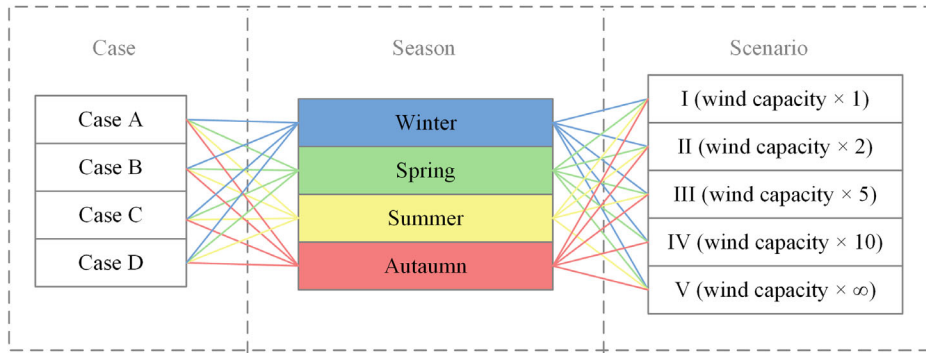

FIGURE 6 Considered states

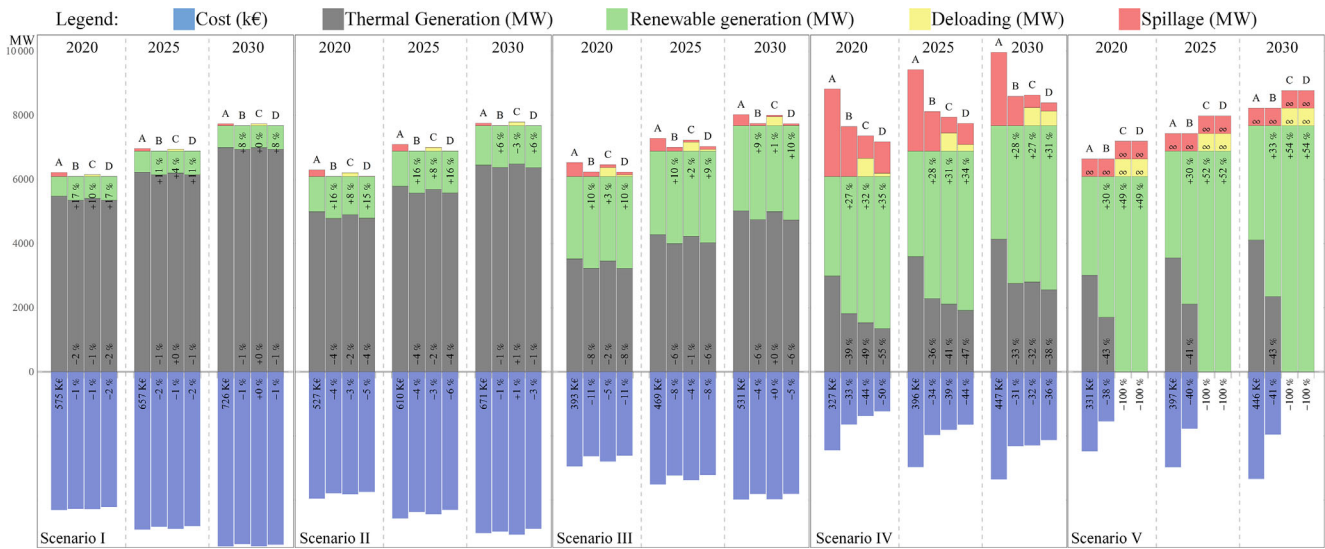

FIGURE 7 The average results of four seasons is shown here for La Palma island. Different cases are specified above each bar. Number of scenarios are stated at bottom corner. Obtained results for years 2020, 2025 and 2030 are separated with dashed lines. *Above zero is the energy in megawatts and below zero is the cost in kilo Euros

- Case D: The possible amount of deloading is defined as a coefficient between 0% and 15% of available wind generation. The UC optimization problem will decide the optimal amount of deloading in each hour. The scheduled amount of RES serves as down reserve.

Figure 6 shows all of the considered states. Weekly unit commitment is performed for four different cases, four sample weeks of different seasons of a year and five wind penetration scenarios for each; composing 80 weekly unit commitments for each year. This approach is employed for three different years: 2020, 2025 and 2030. For each island a total of 240 simulations have been completed.

5.3 | Results

In the following the result obtained for La Palma and Tenerife island are presented and analysed.

5.3.1 | La Palma

The seasonal average results of different scenarios and cases for La Palma island are shown in Figure 7. Different input states are compared, regarding their total cost, scheduled thermal generation, scheduled RES, spilled RES, and deloading of wind turbines. Case A is considered as the base case, then incremental or decremental percentage of thermal energy, renewable energy and cost is inscribed in the figure, comparing to the base case. As the results confirm, mostly the final weekly cost of thermal generation is less for the cases with deloading capability. The amount of spillage is considerably higher in case A, compared to cases B, C, and D. The reason is that case A only depends on the thermal sources to provide both up and down spinning reserve. Because of that in every hour there should be enough generation above minimum capacity to cover down reserve and enough headroom in online units to cover up reserve. This makes it really hard to dispatch renewable energies, hence so much renewable spillage happens even for scenarios with low

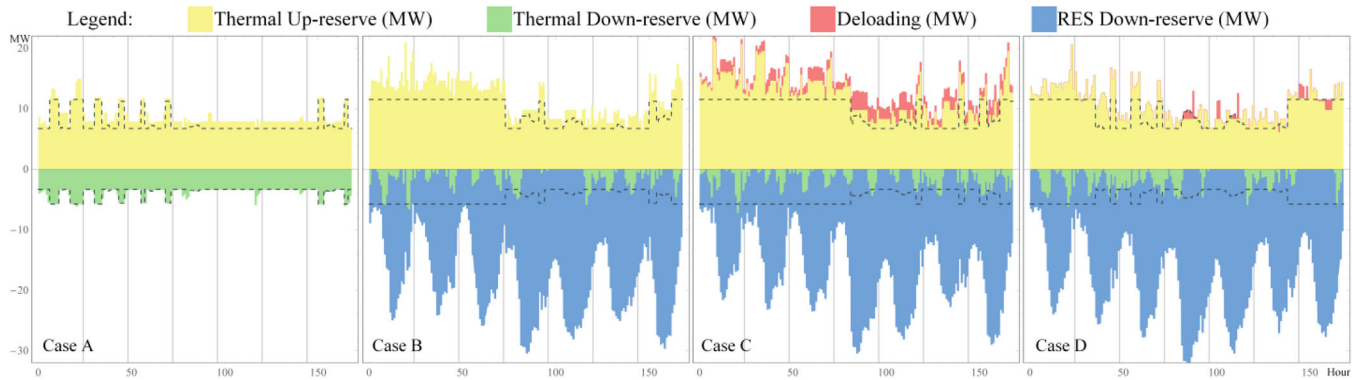

FIGURE 8 Reserve provision by different sources in the system for spring sample week 2020, scenario IV. Dashed lines are up and down reserve requirements in each hour. Days of the week are separated by vertical grey lines

amount of renewable availability. It can be concluded that without enabling renewable sources to provide up and down reserve, increasing renewable capacity is not a smart move, as the rating of spillage is high. The results of case A in Figure 7 confirms the poor performance of case A to use available renewable energy. By doubling the wind injection, the amount of spillage is also approximately doubled in every state for case A.

Enabling RES to provide down reserve in case B, has made considerable improvements in RES scheduling. Even for scenario I, where only the current installed RES is available, around 17% more renewable is scheduled and spillage is totally avoided. The results for scenarios with more RES injection confirm that the effect of providing down reserve by RES is considerably high and always reduces the thermal generation. In scenario IV (multiplying wind capacity by 10), a reduction of 33% of thermal generation and a 31% of cost is expected for year 2030, only thanks to adding the capability of providing down reserve to RES. These reductions even reach to 40% for the extreme scenario V for year 2030.

In case C with fixed percentage of deloading, less spillage has occurred, which has led to a decrement in weekly cost of thermal generation, compared to the base case. But the obtained results of scenarios I–III (scenarios with lower availability of wind), suggest that there is no economic justification for imposing constant deloading of wind for every hour. For case C, cost and thermal generation reduction are apparent from scenario IV. Scenario V is an extreme hypothetical scenario that assumes infinite amount of wind source is available. This means that the amount of deloading for cases C and D is also unlimited. Here the incapability of case A and B to deploy the full potential of RES is better shown. Although infinite RES is available, the weekly expenses of thermal generation cannot be less than a certain amount for case A. The reason is that the up spinning and down spinning reserve constraints will keep some of the thermal generators online to satisfy the required reserve criteria. Then case B manages to reduce the costs around 40%, but still some units should stay online. So, a 100% injection of RES will not be possible, unless RES is also capable of coping with the reserve constraints. The problem with case C from an economic point of view is that it doesn't choose the deloaded

amount optimally. In some hours the up-reserve provision from thermal units might be sufficient, and more renewable generation needed. In these circumstances, it's more cost efficient to deliver more power to the grid and reduce or cut the deloading (also confirmed by Figure 8, which is explained later). Note in Figure 8 that unnecessary deloading occurs in days 1, 2, 3 and 6 of the week in Case C. That's exactly what case D is trying to prevent. It worth noting that the allocated amount of deloading for case C, has never helped to fulfill reserve criteria in this sample week. As expected, case D achieves the most cost-efficient weekly results, compared to the other cases. In fact, in scenarios with low RES availability (Scenarios I, II, III), economic results of a fixed deloading are even worse than when RES only provides down reserve. In these scenarios, the possibility of an optimum variable deloading, slightly reduces the final cost compared to the case with RES providing only down reserve, but the gap starts to grow by going towards scenarios with more renewable injection (Scenarios IV and V). Considering the tendency of operators of Spanish island to reduce thermal generation in the future and add more RES, it seems essential to implement the necessary controllers on the wind turbines to enable the reserve provision capability of wind generators.

In a small island like La Palma, operators should enable RES to participate as down reserve providers, even in current actual situation, to considerably reduce the spillage of RES. Then they should start adding deloading capability to wind turbines, when the installed capacity of wind generation exceeds 5 times of the current capacity (scenarios IV and V), to be as cost efficient as possible.

In Figure 8, it's shown how reserve is provided in each hour for different cases. This figure contains the results for a spring sample week of 2020, scenario IV. As La Palma is a small island, every unit provides a considerable percentage of whole demand, hence in the majority of hours, the biggest online unit is the boundary for reserve criteria of Equation (8). In case A, thermal generation is the only provider of up and down reserve. So, the units are scheduled to generate power and keep enough headroom to satisfy both up and down reserve constraints. Providing up and down reserve is troublesome to the extent that bigger units are online only in some limited hours, just to keep

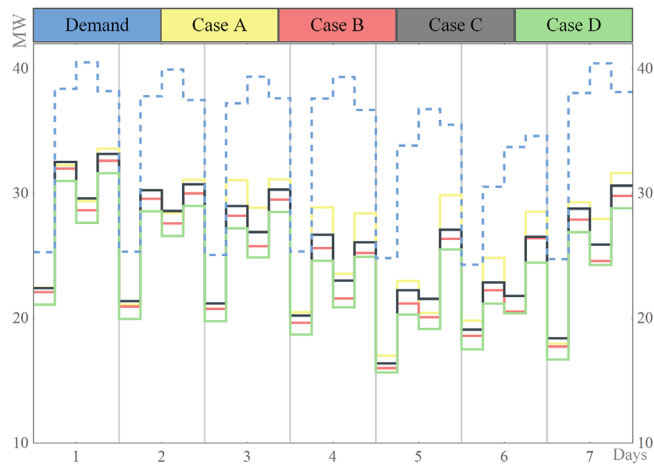

FIGURE 9 Power balance for a spring sample week, 2020, scenario III. Dashed line is the 6-h power demand. Solid lines are the aggregated thermal power generation for corresponding cases A to D

the reserve requirement low. Then in low demand hours, mainly after midnight and in the afternoon (grey lines in the figure divide different days of the week), only smaller units are committed. This is one of the reasons that the cost is higher for case A; solver is forced to turn-off big units, even though they are cheaper, to avoid reserve violation. In case B, with help of RES providing down reserve bigger and cheaper units are online for more hours. Less thermal generation is scheduled to serve as down reserve, which leads to accessing more headroom to serve as up reserve. Also, for cases C and D, there is enough reserve to avoid unnecessary thermal generation. It's deduced from the results of case C that in many hours deloading is unnecessary from an economic point of view and just eliminates some of the available wind generation, which could be used instead of thermal generation. Then in case D, wind generation is only deloaded in the hours that not enough thermal generation up reserve is scheduled. The results for case D show how thermal generation can be minimized and the same time smartly allocate the amount of deloading to participate in up-reserve provision, when needed. In cases B and C, at some hours, the amount of available up reserve is much more than required dashed line. Case D, has managed to satisfy the up-reserve criteria and also not leave much unnecessary headroom.

Figure 9, shows the weekly power balance for a sample week. For the sake of clarity 6-hour power demand is shown instead of hourly. The aggregated amount of thermal generation is illustrated with solid colours. Enabling RES to provide down reserve, increases the share of renewables and reduces the overall thermal generation. As it can be seen in the figure, case D is able to minimize the use of thermal generation.

5.3.2 | Tenerife

For a bigger island like Tenerife, the main qualitative conclusions obtained for La Palma can be also verified. The average results of winter, spring, summer, and autumn are presented in

detail in Figure 10. Enabling renewable sources to provide down reserve, which is the only difference between cases A and B, has always led to reduction in cost and thermal generation. Also, for case B the amount of spillage is decreased for all scenarios, hence more renewable energy is scheduled. The improvement is negligible for first scenarios, but as the available RES increases, the benefits become more noticeable. In scenario IV (multiplying the wind actual wind capacity by 10), a 45% reduction of thermal generation and a 39% of cost reduction is expected for year 2030, only by adding the capability of providing down reserve to RES. These reductions even reach 40% for extreme scenario V for year 2030.

The results show that, imposing a constant percentage of deloading is not economically advisable in a big island like Tenerife, when the penetration of RES is low (economic results are even worse for case C than for case B). However, starting from scenario IV, this approach starts to pay off, and leads to more cost saving with respect to cases A and B. With the current amount of RES or for low RES scenarios in general, enabling them to provide down reserve seems futile. This is especially true for future years (2025 and 2030), where demand also grows and the share of thermal generation slightly increases.

The most cost-efficient results stem from case D. At scenarios I and II, no deloading is scheduled. Then when enough wind power is available, deloading is advisable to minimize cost and thermal generation. In extreme situations, when wind energy is abundant, cases A and B are unable to use the potential, but as expected for case C and D, a 100% renewable generation is possible.

Figure 11 shows how different energy sources are participating to satisfy reserve constraints. As Tenerife is a bigger island, the amount of scheduled RES is the boundary of reserve criteria in Equation (8). So, when higher amount of RES is injected, the required reserve also goes higher. Implementing deloading is beneficial to meet the reserve requirement, when the share of RES grows. In both cases C and D, it is noticeable from Figure 11, that deloading plays an important role in times of high RES injection. It is also evident that in some hours the wind power is unnecessarily deloaded in case C. In case D, deloading is employed more efficiently.

Figure 12, shows the weekly power balance for a sample week. For the sake of clarity 6 h power demand is shown instead of hourly. The aggregated amount of thermal generation is illustrated with solid colours. The dependency of the system to thermal units is considerably higher for case A. Enabling RES to provide reserve increases the ability of the system to benefit from available wind power, as much as possible.

6 | CONCLUSIONS

The paper has evaluated the impact of providing spinning reserve on the system operation costs. Simulations are conducted for La Palma (small size) and Tenerife (medium size) island with various sample of actual and future scenarios to recognize what economic impacts are expected from enabling RES to provide up and down reserve. Up and down reserve are

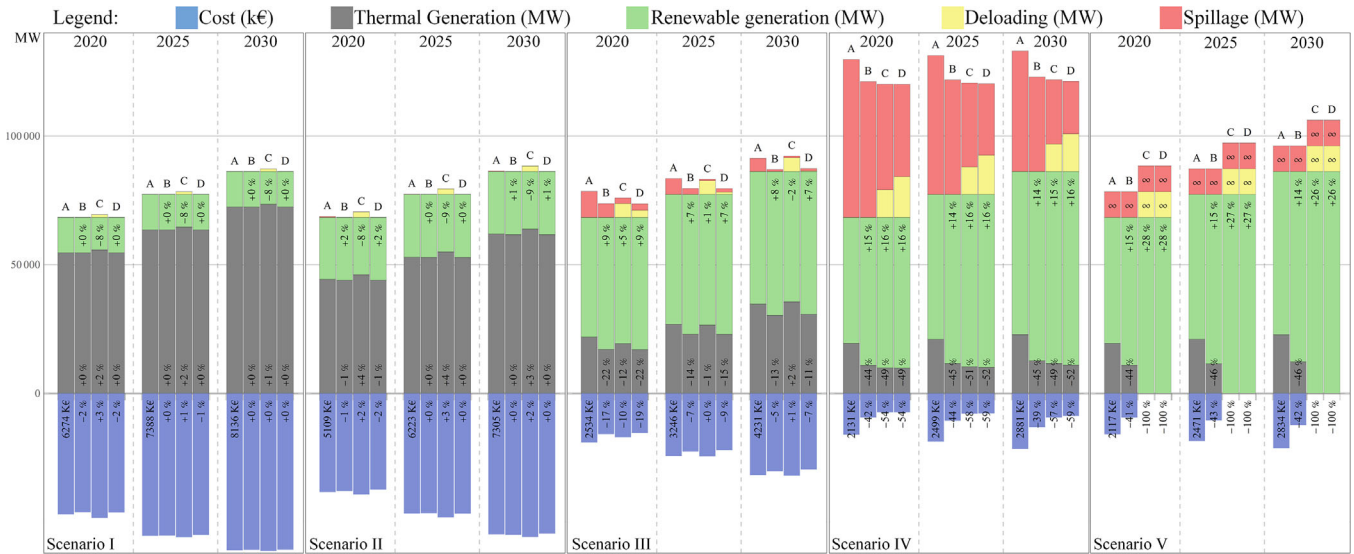

FIGURE 10 The average results of four seasons is shown here for Tenerife island. Different cases are specified above each bar. Number of scenarios are stated at bottom corner. Obtained results for years 2020, 2025 and 2030 are separated with dashed lines. *Above zero is the energy in megawatts and below zero is the cost in kilo Euros

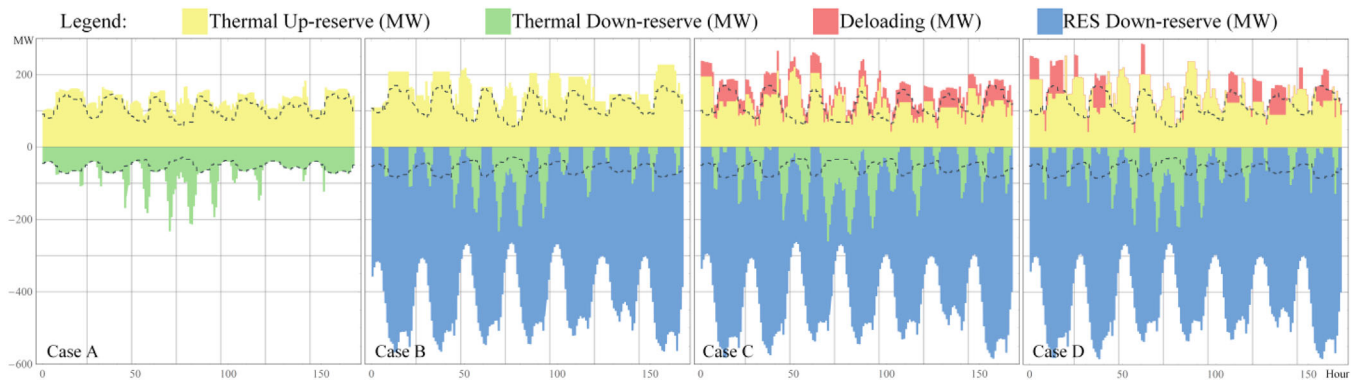

FIGURE 11 Provision of up and down reserve for different cases. The positive dashed lines are the amount of up reserve requirement and the negative dashed lines are the amount of down reserve requirement. Spring, 2030, scenario III

considered separately in both formulation and assumed cases. The economic operation has been simulated by means of an hourly UC on a weekly basis.

Results show that using RES as down reserve providers is always beneficial for a small size island as La Palma where the scarcity of reserve is more severe, where installed RES should immediately be able to provide down reserve to avoid unnecessary spillages and reduce costs. In contrast, it is beneficial only for high wind capacity scenarios for a medium size island as Tenerife. For high penetration levels, providing down reserve reduces more than 40% the amount of thermal generation and more than 30% the systems cost in both islands. For low penetration levels, up spinning reserve provision by wind generation is not justified, but as the availability of wind becomes higher, the benefits of deloading wind generation to participate as up reserve becomes more apparent making 100% renewable generation possible. Deloading a constant percentage of wind for all

hours (case C) is not advisable, since it imposes extra expenses and leads to more thermal generation and can even make economic results worse compared to only providing down reserve (Case B). However, if deloading is treated as a variable (case D), the optimization problem will be able to schedule deloading, deloading RES generation only when it has positive economic impacts. Implementing controllers on RES to enable them to provide down-reserve (case B), always leads to cost reduction. This cost reduction increases, when RES injection goes higher. Considering the future scenarios, the results suggest that providing reserve by RES is vital to inject more renewable energy when a high share of renewables is available in the system and helps leading to a 100% demand coverage by RES. In smaller islands, the scarcity of reserve is more severe and the installed capacity of RES should immediately be able to provide down reserve to avoid unnecessary spillages and reduce costs. For bigger islands like Tenerife, enabling RES to provide down reserve

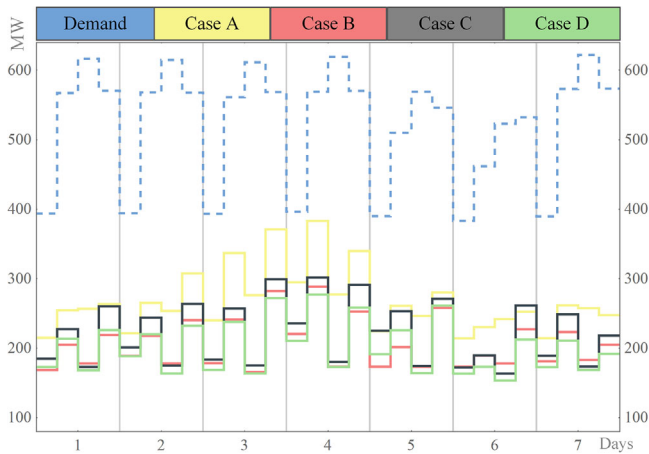

FIGURE 12 Power balance for a summer sample week, 2030, scenario III. Dashed line is the 6-h power demand. Solid lines are the aggregated thermal power generation for corresponding cases A to D

is not urgent, but will be required when the share of RES grows in the future. Future research will tackle the technical benefits of RES reserve provision on the dynamic frequency response of the system.

ACKNOWLEDGEMENT

This study is funded by European Regional Development Fund (ERDF), Ministerio de Ciencia e Innovación - Agencia Estatal de Investigación, Project RTI2018-100965-A-I00.

NOMENCLATURE

The model is defined with set of parameters, binary variables and continuous variables, abbreviated as: Indexes and sets

- $i \in I$ Thermal units, from i to I
- $res \in RES$ Renewable sources, from res to RES
- $dw \in DW$ Deloading wind units, from dw to DW
- $res \in CRES$ Controllable renewable sources providing down reserve, from res to $CRES$
- $t \in \tau$ Hourly periods, in time horizon τ

Parameters

- C_i^{fix} No load cost, [€]
- C_i^{lin} Linear coefficient of the cost variable, [€/MWh]
- C_i^{qua} Quadratic coefficient of the cost variable, [€/MW²h]
- $C_i^{start-up}$ Start-up cost of unit i , [€]
- $C_i^{shut-down}$ Shut-down cost of unit i , [€]
- \overline{P}_i Maximum power of unit i , [MW]
- \underline{P}_i Minimum power of unit i , [MW]
- \overline{R}_i Ramp-up rate of unit i , [MW/h]
- \underline{R}_i Ramp-down rate of unit i , [MW/h]
- $D(t)$ Total power demand in hour t , [MW]
- $P_{res}(t)$ Forecasted renewable generation for time t , [MW]
- $DF(t)$ Deloading factor at time t , [-]
- k_{RV} Expected renewable output variations, [-]

- k_{DR} Down reserve requirement coefficient, [-]
- $P_{res}(t)$ Forecasted power of controllable renewable source res at time t , [MW]

Binary variables

- $x_i(t)$ On/off status of unit i at hour t
- $y_i(t)$ Start-up status of unit i at hour t
- $z_i(t)$ Shut-down status of unit i at hour t

Continuous variables

- $p_i(t)$ Scheduled power generation of unit i at time t , [MW]
- $p_{dw}^{deloaded}(t)$ Deloaded power from wind unit dw , [MW]
- $p_{res}^{spilled}(t)$ Spilled power of renewable source res , [MW]
- $URR(t)$ Up reserve requirement at time t , [MW]
- $DRR(t)$ Down reserve requirement at time t , [MW]
- $r_i^{up}(t)$ Up reserve provided by unit i at time t , [MW]
- $r_i^{down}(t)$ Down reserve provided by unit i at time t , [MW]

ORCID

Mohammad Rajabdorri  <https://orcid.org/0000-0002-4042-7442>

Lukas Sigrist  <https://orcid.org/0000-0003-2177-2029>

REFERENCES

1. Sigrist, L., Egido, I., Rouco, L.: A method for the design of UFLS schemes of small isolated power systems. *IEEE Trans. POWER Syst.* 27(2), 951–958 (2012)
2. Hansen, C.W., Papalexopoulos, A.D.: Operational impact and cost analysis of increasing wind generation in the Island of Crete. *IEEE Syst. J.* 6(2), 287–295 (2012)
3. Gils, H.C., Simon, S.: Carbon neutral archipelago – 100% renewable energy supply for the Canary Islands. *Appl. Energy* 188, 342–355 (2017)
4. Schallenberg-Rodríguez, J.: Photovoltaic techno-economical potential on roofs in the Canary Islands. *J. Sustain. Dev. Energy, Water Environ. Syst.* (2014)
5. Schallenberg-Rodríguez, J., García Montesdeoca, N.: Spatial planning to estimate the offshore wind energy potential in coastal regions and islands. Practical case: The Canary Islands. *Energy* 143, 91–103 (2018)
6. Adefarati, T., Bansal, R.C.: Integration of renewable distributed generators into the distribution system: A review. *IET Renewable Power Gener.* 10(7), 873–884 (2016)
7. Yan, R., et al.: The combined effects of high penetration of wind and PV on power system frequency response. *Appl. Energy* 145, 320–330 (2015)
8. Margaris, I.D., et al.: Frequency control in autonomous power systems with high wind power penetration. *IEEE Trans. Sustain. Energy* 3(2), 189–199 (2012)
9. Liu, J.T., et al.: Method to determine spinning reserve requirement for a grid with large-scale wind power penetration. *J. Eng.* 2017(13), 1686–1691 (2017)
10. Bucksteeg, M., Niesen, L., Weber, C.: Impacts of dynamic probabilistic reserve sizing techniques on reserve requirements and system costs. *IEEE Trans. Sustain. Energy* 7(4), 1408–1420 (2016)
11. Hedayat-Mehdiabadi, M., Hedman, K.W., Zhang, J.: Reserve policy optimization for scheduling wind energy and reserve. *IEEE Trans. Power Syst.* 33(1), 19–31. (2018)
12. Cardell, J.B., Anderson, C.L.: A flexible dispatch margin for wind integration. *IEEE Trans. Power Syst.* 30(3), 1501–1510 (2015)
13. Asensio, M., Contreras, J.: Stochastic Unit Commitment in Isolated Systems With Renewable Penetration Under CVaR Assessment. *IEEE Trans. Smart Grid* 7(3), 1356–1367 (2016)

14. Gu, H., et al.: Zonal inertia constrained generator dispatch considering load frequency relief. *IEEE Trans. Power Syst.* 35(4), 3065–3077 (2020)
15. Wang, Y., et al.: Methods for assessing available wind primary power reserve. *IEEE Trans. Sustain. Energy* 6(1), 272–280 (2015)
16. Gevorgian, V., Zhang, Y., Ela, E.: Investigating the impacts of wind generation participation in interconnection frequency response. *IEEE Trans. Sustain. Energy* 6(3), 1004–1012 (2015)
17. Dai, J., et al.: Aggregation frequency response modeling for wind power plants with primary frequency regulation service. *IEEE Access* 7, 108561–108570 (2019)
18. Teng, F., Strbac, G.: Assessment of the Role and Value of Frequency Response Support from Wind Plants. *IEEE Trans. Sustain. Energy* 7(2), 586–595 (2016)
19. Dreidy, M., Mokhlis, H., Mekhilef, S.: Inertia response and frequency control techniques for renewable energy sources: A review. *Renew. Sustain. Energy Rev.* 69, 144–155 (2017)
20. Pradhan, C., Bhende, C.N.: Enhancement in primary frequency regulation of wind generator using fuzzy-based control. *Electr. Power Components Syst.* 44(15), 1669–1682 (2016)
21. Chang-Chien, L.R., Lin, W.T., Yin, Y.C.: Enhancing frequency response control by DFIGs in the high wind penetrated power systems. *IEEE Trans. Power Syst.* 26(2), 710–718 (2011)
22. Liao, S., et al.: Wide-area measurement system-based online calculation method of PV systems de-loaded margin for frequency regulation in isolated power systems. *IET Renewable Power Gener.* 12(3), 335–341 (2018)
23. Abouzeid, S.I., Guo, Y., Zhang, H.C.: Dynamic control strategy for the participation of variable speed wind turbine generators in primary frequency regulation. *J. Renewable Sustain. Energy* 11(1), 013304 (2019)
24. Shu-Feng, G., et al.: A review of wind turbine deloaded operation techniques for primary frequency control in power system. In: 2018 China International Conference on Electricity Distribution (CICED), Tianjin, China, pp. 63–71 (2018)
25. Vidyanandan, K.V., Senroy, N.: Primary frequency regulation by deloaded wind turbines using variable droop. *IEEE Trans. Power Syst.* 28(2), 837–846 (2013)
26. Pradhan, C., Bhende, C.: Enhancement in primary frequency contribution using dynamic deloading of wind turbines. *IFAC-PapersOnLine* 48(30), 13–18 (2015)
27. Kumar, D., et al.: Modified deloading strategy of wind turbine generators for primary frequency regulation in micro-grid. *Technol. Econ. Smart Grids Sustain. Energy* 5(1), 11 (2020)
28. Consejería de Transición Ecológica Lucha contra el cambio climático y Planificación Territorial: 'Anuario energético de Canarias 2018, 329 (2019) <http://www.gobiernodecanarias.org/istac/jaxi-istac/download.do?uripx=urn:uuid:03339289-7e10-49e9-a0a8-48db16496b89>
29. Sigrist, L., et al.: Economic assessment of smart grid initiatives for island power systems. *Appl. Energy* 189, 403–415 (2017)
30. Ministerio de Industria Energía y Turismo: Real Decreto 738/2015, de 31 de julio. *Boletín Of. del Estado* 183(Sec. I), 66752–66903 (2015)
31. Sigrist, L., et al.: *Island Power Systems*. CRC Press, Boca Raton, Florida (2016)
32. Rajan, D., Takriti, S.: IBM Research Report Minimum Up/Down Polytopes of the Unit Commitment Problem with Start-Up Costs, 119 (2005)
33. Ostrowski, J., Anjos, M.F., Vannelli, A.: Formulations for the unit commitment problem. *IEEE Trans. Power Syst.* 27(1), 39–46 (2012)
34. Lobato Miguélez, E., et al.: An overview of ancillary services in Spain. *Electr. Power Syst. Res.* 78(3), 515–523 (2008)

How to cite this article: Rajabdorri, M., et al.: Viability of providing spinning reserves by RES in Spanish Island power systems. *IET Renew. Power Gener.* 2021;15:2878–2890. <https://doi.org/10.1049/rpg2.12216>