

# GIC Distribution



---

**Carlos David Fernández Barroso**

Division of Industrial Electrical Engineering and Automation  
Faculty of Engineering, Lund University



# Table of contents

Chapter 1.-Introduction .....	16
Chapter 2.-Theoretical background .....	18
Geomagnetic disturbances	18
Geomagnetic induced currents	21
Chapter 3.-Power system components.....	24
Transformers	24
Blocking devices	28
Chapter 4.-Modelling Geomagnetically induced currents .....	30
From GMD to induced currents	30
GIC Power Flow Modelling	33
Test system	33
Chapter 5.-Parametric analysis .....	37
Different countriesComparison between transformers	37
Comparison between transformers	25
Different blocking devices	32
Chapter 6.-GIC distribution .....	50
GIC in a 21 bus system	50
Impact of GMD fields on GIC	54
Grounding resistance in different busses	57
Effect of switching lines/transformers on GIC	62
Chapter 7.-Conclusions .....	67
Chapter 8.-References .....	69
Chapter 9.-Appendix 1.....	71
Where to find GIC commands in PowerWorld	71

## Table of figures

Figure 1 Solar activity affects society through technical systems for electricity supply, electronic communication and global satellite navigation (GNSS). [2].....	19
Figure 2 Three single phase transformers [10] .....	26
Figure 3 Three legged transformer [10].....	26
Figure 4 Five legged transformer [10].....	27
Figure 5 Three-phase shell transformer [10] .....	27
Figure 6 Autotransformer [12] .....	28
Figure 7 4-bus test system [6]. .....	33
Figure 8 4 bus test system under 10 V/km GIC.....	36
Table 9 reactive losses vs GIC field for the two transformers in the systems representing the three countries.....	39
Figure 10 graph reactive losses vs GIC field between countries.....	40
Table 11. Maximum GIC field for each country. ....	40
Table 12 Three phase shell transformers voltage drop, typical US transformer. ....	41
Table 13 5 legged core transformers voltage drop, typical Swedish transformer.....	42
Table 14 3 legged core transformers voltage drop, typical Finish transformer.....	42
Figure 15 Comparison between countries, Voltage reduction. ....	43
Figure 16 Reactive losses for different grounding resistance in a three legged transformer. ...	45
Figure 17 Voltage drop for different grounding resistance in a three legged transformer.....	45
Figure 18 Reactive losses for different grounding resistance in a five legged transformer. ....	46
Figure 19 Voltage drop for different grounding resistance in a five legged transformer.....	47
Figure 20 Reactive losses for different grounding resistance in a three legged shell transform	47
Figure 21 Voltage drop for different grounding resistance in a three legged transformer shell	48
Figure 22 Delta connection working as a capacitor in the grounding of the transformer; delta connection cannot be seen due to the specifications of the software.....	49
Figure 23 Geographical representation of the 21 bus system.....	50
Figure 24 21 bus system under no GIC field.....	51
Figure 25 21 Bus system under 7 V/km.....	53
Figure 26 21 Bus system applying capacitors in three buses.....	54
Figure 27 Induced currents in 21 bus system applying grounding resistances.....	55
Figure 28 Neutral voltages in different buses when applying grounding resistance.....	56
Figure 29 Reactive losses in 21 bus system when increasing grounding resistance everywhere	57
Table 30 GIC in different transformers when increasing grounding resistance in each substation.....	57
Figure 31 Induced current in different busses when modifying resistance in substation 2, full scale.....	59
Figure 32 Induced current in different busses when modifying resistance in substation 2 .....	59
Figure 33 Induced current in different busses when modifying resistance in substation 2 [A] .	60

Figure 34 Induced current in different busses when modifying resistance in substation 3, full scale.....	61
Figure 35 Induced current in different busses when modifying resistance in substation 3 .....	61
Figure 36 Induced current in different busses when modifying resistance in substation 3 [A] .	62
Figure 37 21 Bus system without one of the transformers in parallel.....	63
Figure 38 21 Bus system without two of the transformers in parallel. ....	64
Figure 39 21 Bus system, all transformers and lines.....	65
Figure 40 19 Bus system without all the possible skipped elements.....	65

# Master Thesis “GIC Distribution”

Carlos David Fernández Barroso

Division of Industrial Electrical Engineering and Automation, Lund University

***Abstract- GICs are currents generated by Geomagnetic Disturbances that flow along the electric system and may modify the performance of some elements in it. This can disturb the normal functioning of electric systems.***

## I. INTRODUCTION

Electricity is nowadays necessary, and therefore the system must be reliable in order to provide energy to the consumers. The aim of this project is to study the distribution of Geomagnetic Induced –currents along the system.

## II. THEORETICAL BACKGROUND

Solar GIC are currents with a frequency close to 0 Hz, therefore, they can be considered as direct current. When a solar storm occurs, it disturbs the magnetosphere of the earth and, according to the Faraday’s law [1] an electromotive force across a conductor is created when it is exposed to a varying magnetic field.

Induced currents flow through the lines along with the AC current that is being supplied as normal operation; this may affect certain elements such as transformers and can disturb the proper functioning of the electric system.

Direct currents flowing through transformers cause a vertical shift on the B-H curve of the transformer, it moves the normal point of operation closer to saturation. If the transformer reaches its saturation point it will not work and it may lead to a blackout.

## III. Material

In this study the most important devices to be taken into account are transformers and blocking devices. Transformers change the voltage and the current maintaining the same power at both sides of it,  $P=V*I$ . The core of the transformers can be formed as a three-legged core, five-legged core or in the shape of a shell core transformer, this will affect the way that the transformers behave.

Blocking devices are divided between grounding resistance or capacitors. Capacitors installed in the grounding of the transformers impede the flow of DC currents through them; this will stop the GIC from flowing to soil. Grounding resistances can also be installed at the grounding of the transformers; increasing the resistance the induced current will be lower.

## IV. Modelling GIC

Geomagnetic Induced currents flow along conductors, the magnitude of them depends on the electromagnetic field, the direction, the length of the line and the resistance of it. To calculate

the GMD-induced voltage on transmission line k,  $U_k$ , the electric field is just integrated over the length of the transmission line [2].

$$U_k = \oint_C \vec{E} \cdot d\vec{l} \quad (2)$$

This field can be split into two terms according to its coordinates.

$$U_K = E_{k,N} \cdot L_{k,N} + E_{k,E} \cdot L_{k,E} \quad (3)$$

#### V. PARAMETRIC ANALYSIS

Two models have been used in order to study the distribution of induced currents. The first model is a PowerWorld 4 bus model, in which different conditions have been tested such as different fields, directions or use of blocking devices. In the first model three different studies will be carried out, the first one being different cores of transformers and the use or not of blocking devices. After the study it can be proved that the three legged transformer is the one with less reactive losses and less voltage drop; a priori this one will be the more convenient and the most suitable for all situations. It has been proved that the use of blocking devices diminishes the induced current, in the case of grounding resistance; or eliminates the induced current in case of the capacitor.

#### VI. TEST IN A MORE REALISTIC SYSTEM

Several tests in a more realistic system, such as the 21 bus system provided by PowerWorld presented below.

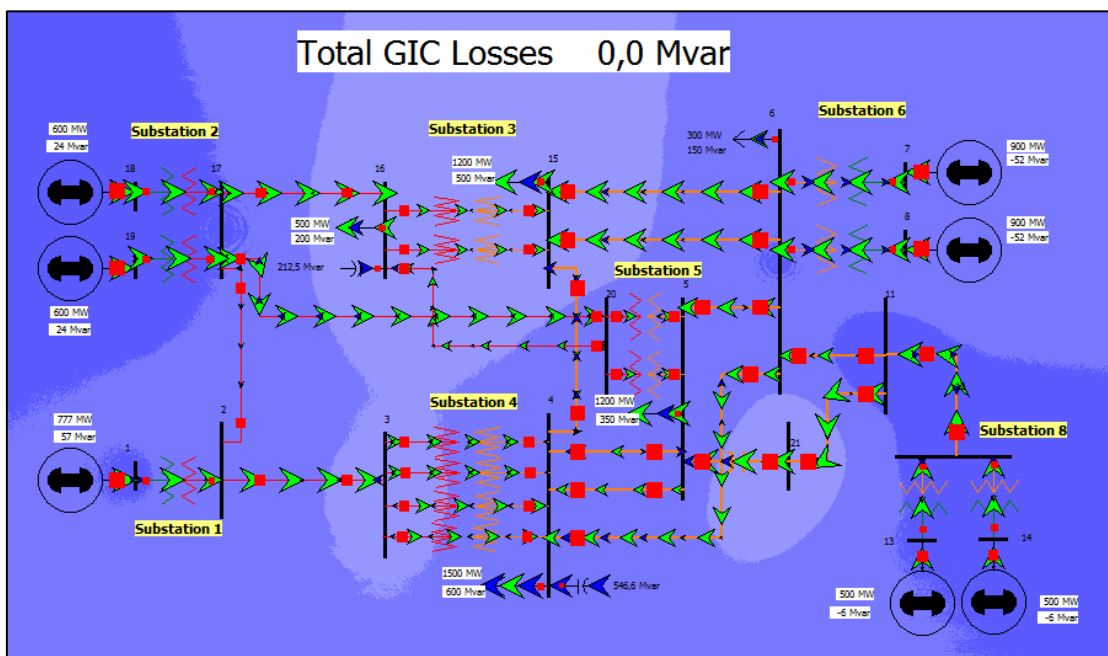

Figure 1 21 bus test system with no GIC.

This system will be used to test the different blocking devices and study the distribution of GIC under different conditions. This system is more realistic and the results can be applied in real systems.

## VII. RESULTS

After studying the different blocking devices for all conditions; it can be concluded that both capacitors and grounding resistance diminish the flow of GIC along the system. Capacitors protect the bus where they are located but grounding resistances are expected to diminish the current in the whole system.

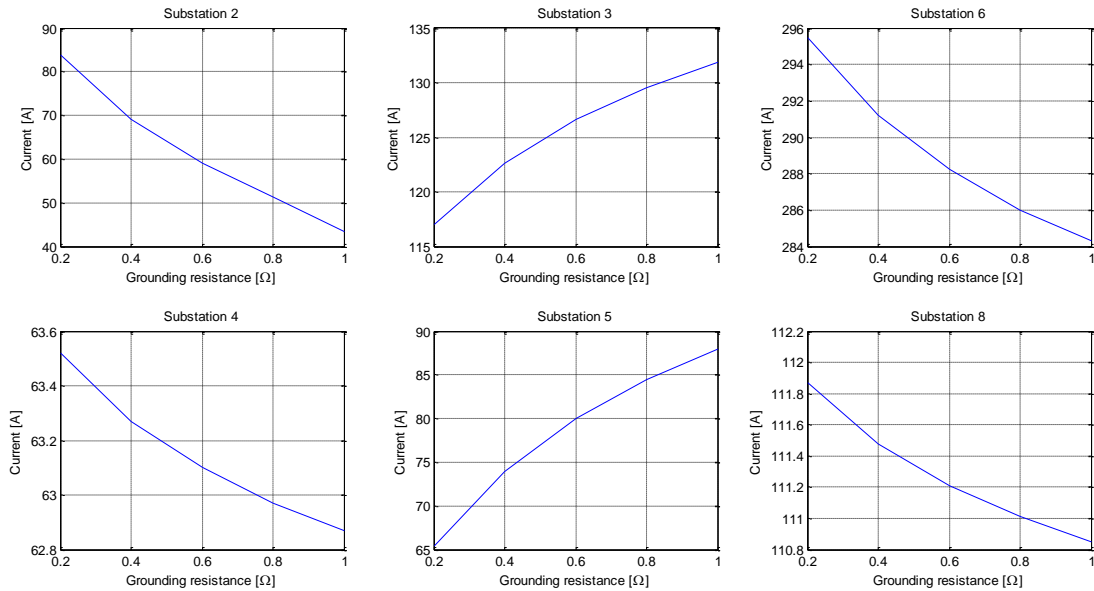

Figure 2 Induced currents in different busses when changing grounding resistance in bus 2 under a 5V/km GIC field.

As can be seen in the previous graph the induced currents can increase when increasing grounding resistance in a certain substation. This is due to the different loops of the net, in some of them increase in order to compensate the loss of current in the first substation. However overall the GIC currents are lower and also the reactive losses.

## VIII. CONCLUSIONS.

The main conclusion of this study is that both capacitors and grounding resistance are applicable to assure the system against GIC currents. Grounding resistances are a better solution overall because they protect the whole system, not only the substation where they are installed. It is shown however, that while a grounding resistance decreases the overall GIC, it also increases GIC at some locations. There must be a compromise in the grounding resistance, if it is too large the voltage during asymmetrical faults is too large; therefore the grounding resistance must not be too large.

## IX. REFERENCES

- [1] T.R. Hutchins, T.J. Overbye "The effect of geomagnetic disturbances on the electric grid and appropriate mitigation strategies", (2012).
- [2] T. J. Overbye, Komal S. Shetye, T. R. Hutchins, Q. Qiu, J. D. Weber, "Power Grid Sensitivity Analysis of Geomagnetically Induced Currents" (2013).



# Master Thesis “GIC Distribution”

Carlos David Fernández Barroso

Division of Industrial Electrical Engineering and Automation, Lund University

***Resumen-GICs son corrientes generadas por perturbaciones geomagnéticas que fluyen a lo largo del sistema eléctrico y pueden modificar el rendimiento de algunos elementos en los mismos. Esto puede perturbar el funcionamiento normal de los sistemas eléctricos.***

## INTRODUCCIÓN

La electricidad es hoy en día es necesario, y por lo tanto el sistema debe ser fiable a fin de proporcionar energía a los consumidores. El objetivo de este proyecto es estudiar la distribución de los geomagnéticas inducida por las corrientes a lo largo del sistema.

### I. MARCO TEÓRICO

GIC son corrientes con una frecuencia cercana a 0 Hz, por lo tanto, pueden ser considerados como de corriente continua. Cuando se produce una tormenta solar, que perturba la magnetosfera de la Tierra y, según la ley de Faraday [1] se crea una fuerza electromotriz a través de un conductor cuando se expone a un campo magnético variable.

Las corrientes inducidas por el flujo a través de las líneas junto con la corriente de CA que está siendo suministrado como el funcionamiento normal; esto puede afectar a ciertos elementos, tales como transformadores y puede perturbar el buen funcionamiento del sistema eléctrico.

Directos corrientes que fluyen a través de transformadores causan un desplazamiento vertical en la curva BH del transformador, se mueve el punto de operación normal más cerca de la saturación. Si el transformador alcanza su punto de saturación, no va a funcionar y que puede conducir a un apagón.

### II. MATERIAL

En este estudio los dispositivos más importantes que deben tenerse en cuenta son los transformadores y los dispositivos de bloqueo. Transformadores de cambiar el voltaje y el mantenimiento de la corriente de la misma potencia en ambos lados de la misma,  $p = V * I$ . El núcleo de los transformadores se puede formar como un núcleo de tres patas, base de cinco patas o en la forma de un transformador de núcleo de shell, esto afectará a la forma en que se comportan los transformadores.

Dispositivos de bloqueo están divididos entre la resistencia de puesta a tierra o condensadores. Los condensadores instalados en la conexión a tierra de los transformadores impiden el flujo de corrientes de CC a través de ellos; esto detendrá el GIC fluya hacia el suelo. Resistencias de puesta a tierra también se pueden instalar en la conexión a tierra de los transformadores; el aumento de la resistencia a la corriente inducida será menor.

### III. MODELLING GIC

Geomagnéticas corrientes inducidas por el flujo a lo largo de los conductores, la magnitud de ellos depende del campo electromagnético, la dirección, la longitud de la línea y la resistencia de la misma. Para calcular la tensión inducida-GMD en línea k de transmisión, el campo eléctrico es sólo integra a lo largo de la longitud de la línea de transmisión [2].

$$U_k = \oint_C \vec{E} \cdot d\vec{l} \quad (2)$$

Este campo se puede dividir en dos términos de acuerdo con sus coordenadas.

$$U_K = E_{k,N} \cdot L_{k,N} + E_{k,E} \cdot L_{k,E} \quad (3)$$

#### IV. PARAMETRIC ANALYSIS

Dos modelos se han utilizado con el fin de estudiar la distribución de corrientes inducidas. El primer modelo es un modelo de autobús PowerWorld 4, en el que diferentes condiciones han sido probados como diferentes campos, direcciones o el uso de los dispositivos de bloqueo. En el primer modelo se llevarán a cabo tres estudios diferentes, el primero es diferentes núcleos de transformadores y el uso o no de dispositivos de bloqueo. Tras el estudio se puede demostrar que las tres patas del transformador es el que tiene menos pérdidas reactivas y menos caída de tensión; a priori, éste será el más cómodo y el más adecuado para todas las situaciones. Se ha demostrado que el uso de dispositivos de bloqueo disminuye la corriente inducida, en el caso de la resistencia de puesta a tierra; o elimina la corriente inducida en el caso del condensador.

#### V. TEST IN A MORE REALISTIC SYSTEM

Varias pruebas en un sistema más realista, como el sistema de bus 21 proporcionadas por PowerWorld presentan a continuación.

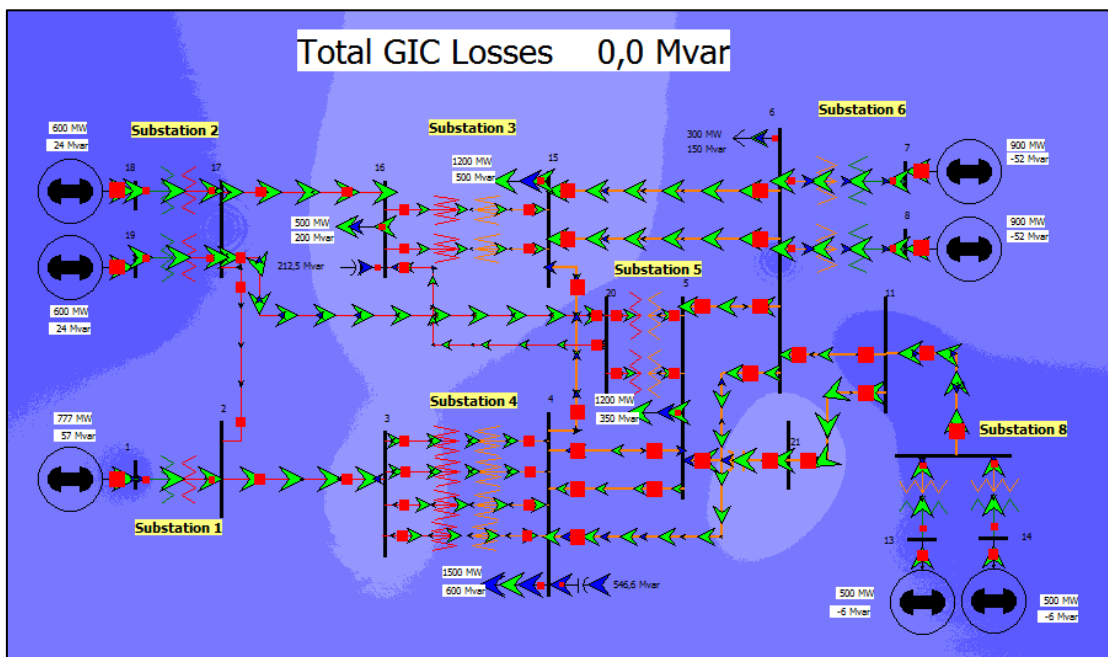

Figure 3 21 bus test system with no GIC.

Este sistema se utilizará para probar los diferentes dispositivos de bloqueo y estudiar la distribución de los GIC en diferentes condiciones. Este sistema es más realista y los resultados se puede aplicar en los sistemas reales.

## VI. RESULTS

Después de estudiar los diferentes dispositivos de bloqueo para todas las condiciones; se puede concluir que ambos condensadores y la resistencia de puesta a tierra disminuyen el flujo de GIC a lo largo del sistema. Condensadores protegen el bus en el que se encuentran, pero se espera que las resistencias de puesta a tierra para disminuir la corriente en todo el sistema.

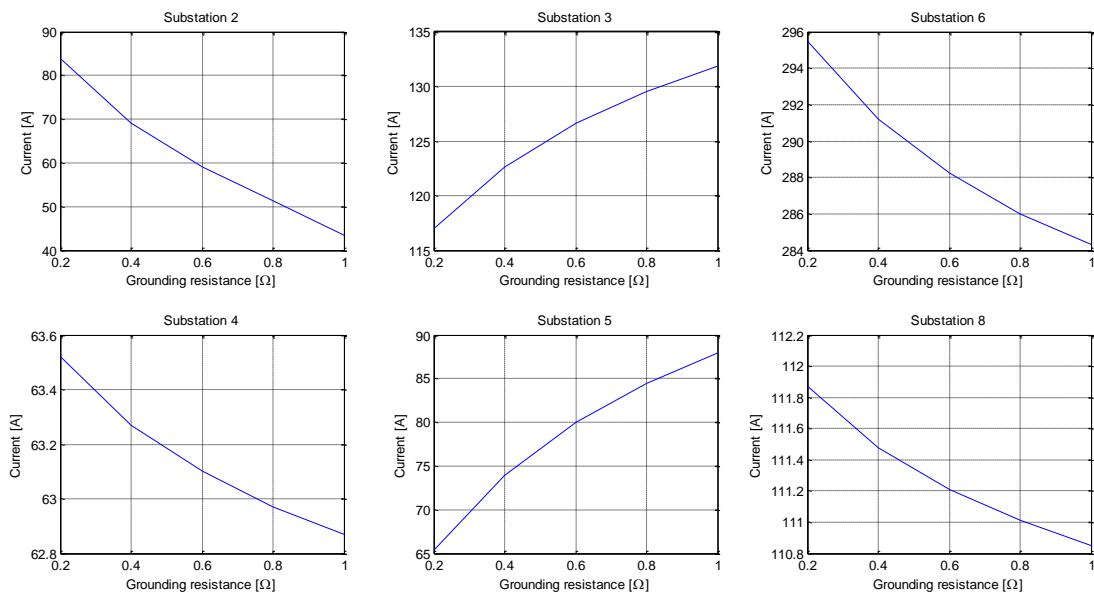

Figure 4 Induced currents in different busses when changing grounding resistance in bus 2 under a 5V/km GIC field.

Como se puede ver en el gráfico anterior las corrientes inducidas pueden aumentar cuando se aumenta la resistencia de puesta a tierra en un cierto subestación. Esto es debido a los diferentes bucles de la red, en algunos de estos incrementan con el fin de compensar la pérdida de corriente en la primera subestación. Sin embargo en general las corrientes GIC son menores y también las pérdidas reactivas.

## VII. CONCLUSIONS.

La principal conclusión de este estudio es que los dos condensadores y resistencias de puesta a tierra son de aplicación para asegurar el sistema contra las corrientes de GIC. Resistencias de puesta a tierra son una mejor solución global, ya que protegen el sistema entero, no sólo la subestación donde se instalen. Sin embargo, se muestra, que, si bien una resistencia de puesta a tierra disminuye el GIC en general, sino que también aumenta GIC en algunos lugares. Debe haber un compromiso en la resistencia de puesta a tierra, si es demasiado grande la tensión durante fallas asimétricas es demasiado grande; Por lo tanto, la resistencia de puesta a tierra no debe ser demasiado grande.

## VIII. REFERENCES

- [1] T.R. Hutchins, T.J. Overbye “The effect of geomagnetic disturbances on the electric grid and appropriate mitigation strategies”, (2012).
- [2] T. J. Overbye, Komal S. Shetye, T. R. Hutchins, Q. Qiu, J. D. Weber, “Power Grid Sensitivity Analysis of Geomagnetically Induced Currents” (2013).

## **AUTORIZACIÓN PARA LA DIGITALIZACIÓN, DEPÓSITO Y DIVULGACIÓN EN ACCESO ABIERTO ( RESTRINGIDO) DE DOCUMENTACIÓN**

### **1ª. Declaración de la autoría y acreditación de la misma.**

El autor D. Carlos David Fernández Barroso, como Alumno de la UNIVERSIDAD PONTIFICIA COMILLAS (COMILLAS), **DECLARA**

que es el titular de los derechos de propiedad intelectual, objeto de la presente cesión, en relación con la obra GIC Distribution que ésta es una obra original, y que ostenta la condición de autor en el sentido que otorga la Ley de Propiedad Intelectual como titular único o cotitular de la obra.

En caso de ser cotitular, el autor (firmante) declara asimismo que cuenta con el consentimiento de los restantes titulares para hacer la presente cesión. En caso de previa cesión a terceros de derechos de explotación de la obra, el autor declara que tiene la oportuna autorización de dichos titulares de derechos a los fines de esta cesión o bien que retiene la facultad de ceder estos derechos en la forma prevista en la presente cesión y así lo acredita.

### **2ª. Objeto y fines de la cesión.**

Con el fin de dar la máxima difusión a la obra citada a través del Repositorio institucional de la Universidad y hacer posible su utilización de *forma libre y gratuita* ( *con las limitaciones que más adelante se detallan*) por todos los usuarios del repositorio y del portal e-ciencia, el autor **CEDE** a la Universidad Pontificia Comillas de forma gratuita y no exclusiva, por el máximo plazo legal y con ámbito universal, los derechos de digitalización, de archivo, de reproducción, de distribución, de comunicación pública, incluido el derecho de puesta a disposición electrónica, tal y como se describen en la Ley de Propiedad Intelectual. El derecho de transformación se cede a los únicos efectos de lo dispuesto en la letra (a) del apartado siguiente.

### **3ª. Condiciones de la cesión.**

Sin perjuicio de la titularidad de la obra, que sigue correspondiendo a su autor, la cesión de derechos contemplada en esta licencia, el repositorio institucional podrá:

(a) Transformarla para adaptarla a cualquier tecnología susceptible de incorporarla a internet; realizar adaptaciones para hacer posible la utilización de la obra en formatos electrónicos, así como incorporar metadatos para realizar el registro de la obra e incorporar “marcas de agua” o cualquier otro sistema de seguridad o de protección.

(b) Reproducirla en un soporte digital para su incorporación a una base de datos electrónica, incluyendo el derecho de reproducir y almacenar la obra en servidores, a los efectos de garantizar su seguridad, conservación y preservar el formato. .

(c) Comunicarla y ponerla a disposición del público a través de un archivo abierto institucional, accesible de modo libre y gratuito a través de internet.<sup>1</sup>

(d) Distribuir copias electrónicas de la obra a los usuarios en un soporte digital.<sup>2</sup>

#### **4º. Derechos del autor.**

El autor, en tanto que titular de una obra que cede con carácter no exclusivo a la Universidad por medio de su registro en el Repositorio Institucional tiene derecho a:

a) A que la Universidad identifique claramente su nombre como el autor o propietario de los derechos del documento.

b) Comunicar y dar publicidad a la obra en la versión que ceda y en otras posteriores a través de cualquier medio.

c) Solicitar la retirada de la obra del repositorio por causa justificada. A tal fin deberá ponerse en contacto con el vicerrector/a de investigación ([curiarte@rec.upcomillas.es](mailto:curiarte@rec.upcomillas.es)).

d) Autorizar expresamente a COMILLAS para, en su caso, realizar los trámites necesarios para la obtención del ISBN.

d) Recibir notificación fehaciente de cualquier reclamación que puedan formular terceras personas en relación con la obra y, en particular, de reclamaciones relativas a los derechos de propiedad intelectual sobre ella.

#### **5º. Deberes del autor.**

El autor se compromete a:

a) Garantizar que el compromiso que adquiere mediante el presente escrito no infringe ningún derecho de terceros, ya sean de propiedad industrial, intelectual o cualquier otro.

b) Garantizar que el contenido de las obras no atenta contra los derechos al honor, a la intimidad y a la imagen de terceros.

---

<sup>1</sup> En el supuesto de que el autor opte por el acceso restringido, este apartado quedaría redactado en los siguientes términos:

(c) Comunicarla y ponerla a disposición del público a través de un archivo institucional, accesible de modo restringido, en los términos previstos en el Reglamento del Repositorio Institucional

<sup>2</sup> En el supuesto de que el autor opte por el acceso restringido, este apartado quedaría eliminado.

c) Asumir toda reclamación o responsabilidad, incluyendo las indemnizaciones por daños, que pudieran ejercitarse contra la Universidad por terceros que vieran infringidos sus derechos e intereses a causa de la cesión.

d) Asumir la responsabilidad en el caso de que las instituciones fueran condenadas por infracción de derechos derivada de las obras objeto de la cesión.

#### **6º. Fines y funcionamiento del Repositorio Institucional.**

La obra se pondrá a disposición de los usuarios para que hagan de ella un uso justo y respetuoso con los derechos del autor, según lo permitido por la legislación aplicable, y con fines de estudio, investigación, o cualquier otro fin lícito. Con dicha finalidad, la Universidad asume los siguientes deberes y se reserva las siguientes facultades:

a) Deberes del repositorio Institucional:

- La Universidad informará a los usuarios del archivo sobre los usos permitidos, y no garantiza ni asume responsabilidad alguna por otras formas en que los usuarios hagan un uso posterior de las obras no conforme con la legislación vigente. El uso posterior, más allá de la copia privada, requerirá que se cite la fuente y se reconozca la autoría, que no se obtenga beneficio comercial, y que no se realicen obras derivadas.

- La Universidad no revisará el contenido de las obras, que en todo caso permanecerá bajo la responsabilidad exclusiva del autor y no estará obligada a ejercitar acciones legales en nombre del autor en el supuesto de infracciones a derechos de propiedad intelectual derivados del depósito y archivo de las obras. El autor renuncia a cualquier reclamación frente a la Universidad por las formas no ajustadas a la legislación vigente en que los usuarios hagan uso de las obras.

- La Universidad adoptará las medidas necesarias para la preservación de la obra en un futuro.

b) Derechos que se reserva el Repositorio institucional respecto de las obras en él registradas:

- retirar la obra, previa notificación al autor, en supuestos suficientemente justificados, o en caso de reclamaciones de terceros.

Madrid, a 23 de Junio de 2014

**ACEPTA**

Fdo.....



Proyecto realizado por el alumno/a:

(Poner el nombre del alumno/a)

Fdo.: .....

Fecha: ...../ ...../ .....

Autorizada la entrega del proyecto cuya información no es de carácter confidencial

EL DIRECTOR DEL PROYECTO

(poner el nombre del Director del Proyecto)

Fdo.: .....

Fecha: ...../ ...../ .....

Vº Bº del Coordinador de Proyectos

(poner el nombre del Coordinador de Proyectos)

Fdo.: .....

Fecha: ...../ ...../ .....

# Chapter 1

## Introduction

**E**lectricity is nowadays necessary, centuries ago it was discovered and then commercialized and its use has been increasing ever since. The transport of electricity relies on the correct working of generators, lines and transformers.

High-impact low-frequency (HILF) events present a threat to the power system. There are two main HILF events of relevance here, those being high-altitude electromagnetic pulse detonation (HEMP) and geomagnetic disturbances (GMDs) due to space weather [1]. This project will focus on the study of the effect of GMDs on the transmission system.

The GMD, if large enough, can disrupt grid operation, causing initial blackouts and also pose a threat for permanent damage to large transformers, which can lead to restoration delays for the grid operation; a single event can make the system collapse and not be restored for weeks, with the consequent economic losses. Because the problem has been identified and options exist for reduction, elimination, and/or management of the GMD threat, much of the severe impact to the power grid from these threat environments should be viewed as preventable.

The fluctuation of the magnetic field in the magnetosphere caused by GMD can induce currents along all kind of electric conductors, such as pipes, railways or transmission lines. These currents will be called Geomagnetic Induced Currents (GICs). The ability to resist such events resides in the elements that compose the grid. The goal of this research is to study the different mitigation systems and its impact on the grid, in particular how distribution of GIC in the network is affected.

In order to secure the reliability of the power system certain mitigation strategies are necessary. The simulation of GIC through software will allow the user to study deeply the behaviour of the induced currents and how to minimize them and mitigate their effects.

This project will be focused on the different methods of mitigation of GMD events in transmission lines, as case study three countries will be analysed, Sweden, Finland and

the United States of America. These three countries have different system conditions and are interesting to compare.

A first assessment will be done in a small four bus system and then the found statements will be proved in a bigger and more realistic grid. The goal of this project is to compare the different systems and find an appropriate solution for each case.

Recently GIC calculations have been integrated with a standard power flow analysis software. This will enable exploration of short term and long term mitigation strategies of GMD scenarios and their impact on the power grid. The software used for this task will be the PowerWorld simulator, a programme able to simulate all stages and possible situations related to GIC currents.

## Chapter 2

# Theoretical background

Solar weather can severely affect electric systems, solar storms will produce Geomagnetic disturbances when in contact with the magnetosphere and these, in turn will induce currents along the lines of the system, possibly preventing from the proper functioning of it.

## Geomagnetic disturbances

The geomagnetic disturbances are caused by solar storms, or solar flares. Coronal mass ejections happening on the surface of the sun cause solar flares which are made out of mainly protons and neutrons. The magnetic field of the Earth captures the particles roughly one or two days after the flare happens in the sun [7]. Caused by the capture of energized plasma, severe changes happen in the magnetic field of the Earth. Solar cycles last for 11-years, with solar activity increasing as the cycle approaches its end; that is, the end of the cycle is more intense than the beginning [7]. The current solar cycle, solar cycle 24, started in 2008, and the number of storms per year has also been increasing [7].

Geomagnetic storms are mainly caused by interplanetary disturbances driven by fast coronal mass ejections [3]. Some recurrent storms are increased by solar wind disturbances produced only by coronal mass ejections. Many coronal mass ejections do not produce large disturbances either in the solar wind or in the magnetic field of the Earth. Certain evidences prove that approximately 1 out of 6 coronal mass ejection-driven disturbances hitting the magnetic field of the Earth ends up driving a large geomagnetic storm [4].

Space weather and its consequent effects may affect technical systems that are needed for nowadays' society. The most frequently addressed are electric power systems, electronic communication systems and global navigation satellite systems (GNSS), Figure 1. Other affected systems include, for example, air traffic and shipping [2].

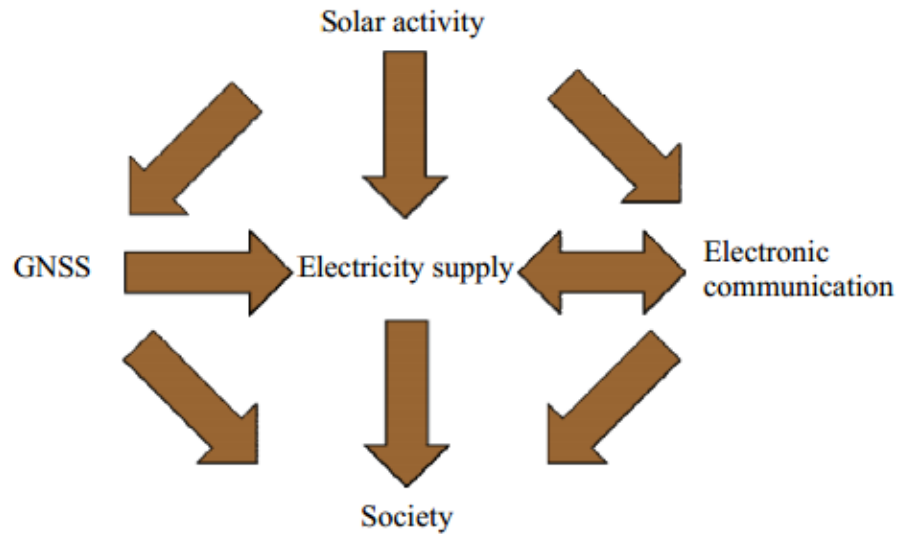

Figure 5 Solar activity affects society through technical systems for electricity supply, electronic communication and global satellite navigation (GNSS). [2]

The solar storm of 1859 known as the “Carrington event” was the largest solar storm noted, it occurred during solar cycle 10, and was caused by a massive solar flare hitting the magnetic field of the Earth. The largest recorded geomagnetic storm occurred on the beginning of September, 1859. Aurorae were seen around the world, even as far south as the Caribbean [5]. Solar storms may occur in different stages of the solar cycle, but they are more likely to happen during the solar maximum, i.e. the time when solar activity is more intense. Along with other solar storms, the one of 1989 Québec was especially important due to its effects on electric systems and the grid.[5]

A coronal mass ejection caused this geomagnetic storm on March 9, 1989. Some days before, on March 6th, a very large solar flare also happened. Three and a half days after that, on March 13, a severe geomagnetic storm hit the Earth’s magnetosphere. Extraordinarily intense auroras at the poles were seen at the beginning of the storm [5].

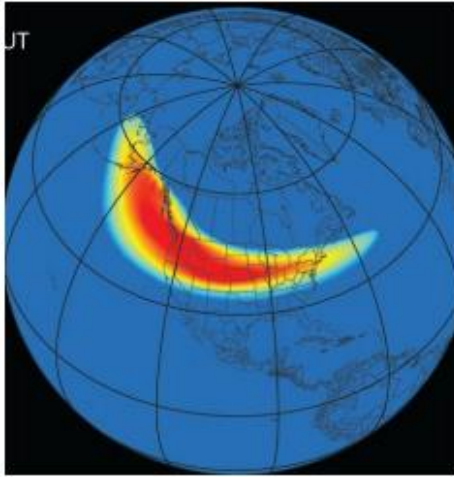

Figure 2 1989 Solar storm [5]

The image at the left depicts the peak of the geomagnetic disturbances caused by the storm with a magnitude of 500 nT/min.

A 100 ton static VAR compensator (SVC) at Chibougamau sub-station, Québec, Canada, tripped and went offline due to GIC causing a protective relay to sense overload conditions. [6]

The tripped VAR capacitor caused a chain of failures throughout the Québec power grid; most notably five transmission lines from James Bay were tripped causing a loss of 9,450 MW. The

total load in the grid at the time was about 21,350 MW. 75 seconds after the first capacitor went down most of Québec was left without power. Some towns and regions were disconnected as an attempt to restore balance in the power system but failing, the power was not restored. This chain of failures was much too fast for the operators to use any significant form of manual intervention. 6 million of Hydro-Québec's customers were left without power for up to 9 hours [6].

The electric company was forced to implement various mitigation strategies after the power failure, including raising the trip level of relay protection, installing series compensation on high voltage lines and upgrading several monitoring and operational procedures. Other TSOs in various countries around the world implemented programs to reduce the risks associated with geomagnetic induced currents [5].

Geomagnetic induced currents (GIC), modifying the regular working of electric lines and the system, are a manifestation of space weather. Electric currents in the magnetosphere and ionosphere, when in case of space weather events, experience large variations, which are revealed also in the magnetosphere of the Earth. These variations induce currents (GIC) in conductors operated on the surface of Earth.

According to Faraday's law of induction; a changing magnetic field seen by an electric conductor results in an induced electromagnetic field. A geomagnetic storm interacting with the Earth's magnetosphere induces geoelectric fields at the surface of the Earth and in the ground. The geoelectric fields induce currents in all electric conductors on the

ground such as high voltage transmission lines, railway equipment, communication cables, and pipeline networks [7].

## Geomagnetic induced currents

GIC are approximately direct currents as their frequencies are usually in the order of  $0.0001 \sim 0.1$  Hz which are smaller than the normal frequency of the power system (50 Hz or 60 Hz). The duration of these incidents can be in the order of several minutes to several hours [6]. A DC current flowing through the windings of a power transformer generates a DC flux in the core which magnitude depends on the magnitude of the DC current, number of turns in the windings carrying the current and reluctance of the DC flux path [20]. The overlapped DC flux shifts the operating point of the transformer approaching its saturation point and this, consequently causes half cycle saturation in the core resulting in harmonic currents, forcing the flux to flow outside the core and increased reactive power consumption.

The behaviour of the GICs in the electric transmission system depends on the induced DC current in the power lines and the resistance of the different elements of the system. Since the GICs are essentially DC, the induced flow does not depend on the reactances of the different elements. Behaviour of GICs depend on the resistance of the transmission lines, the resistance of the coils of grounded transformers, the resistance of the series windings of autotransformers (and their common winding if grounded), and the substation grounding resistance instead.[16]

In order to study a DC power system, the main aspects that must be taken into consideration are the topology of the core, the nonlinearity of ferromagnetic materials, the coupling and connection of coils, and the system series resistances.

The nonlinear behaviour of a saturated transformer is dependent on the DC flux offset. The path through the transformer GIC to create this compensation is unrelated to the effects observed by the transformer. The transformer reactive power consumption is directly related with the net DC flux in the transformer. According to this fact, and understanding the basic behaviour of geomagnetic induced currents along the system, reactive power consumption can be used as a trace of GIC levels in the system.

The GIC field varies depending on the latitude and on space weather; the magnetic field has been recorded by partners in the European project EURISGIC for many years. On Figure 3 it can be observed the maximum electric field for the countries of Finland and Sweden in the period 1996-2008. The maximum field recorded was 5 V/km. The realistic estimations about GIC tell us no more than 5 V/km [19], the study will however be done up to 10 V/km to cover slightly more severe fields.

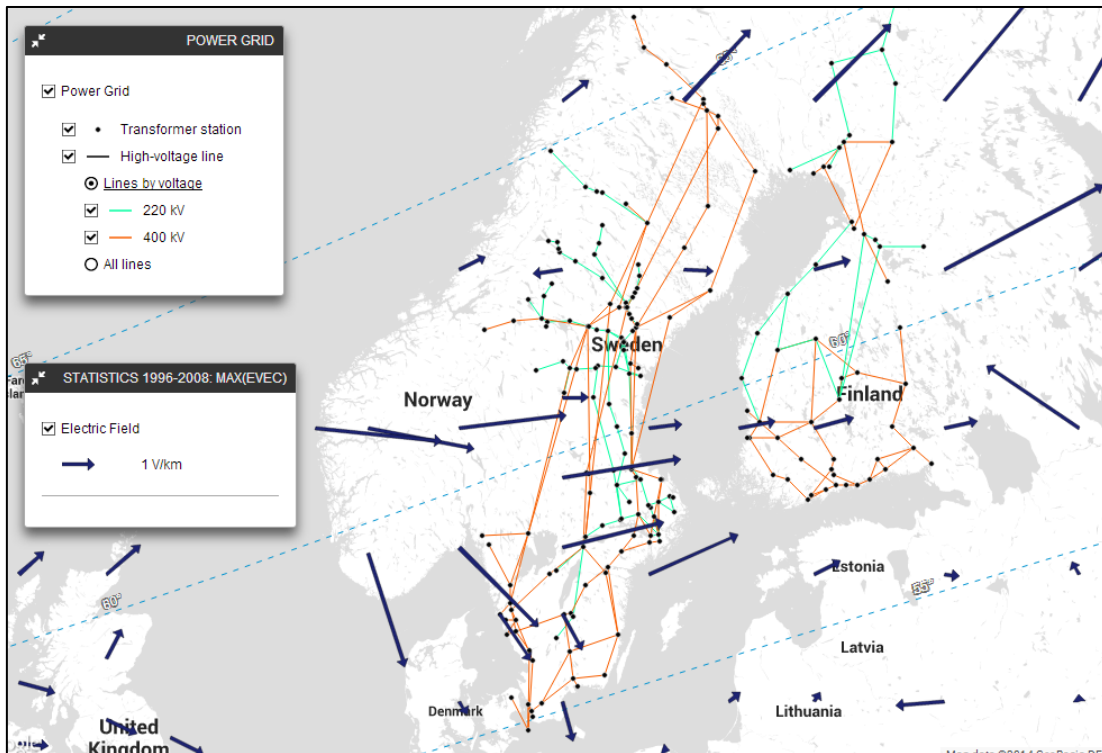

Figure 3 Maximum Electric fields in Northern Europe 1996-2008 [11]

GIC has an important effect on high voltage transmission lines as well as power transformers, if DC induced currents increase then reactive losses in the transformers will rise. The reactive power consumed by the line increases with the square of the line's current but the reactive power consumed by the transformer increase in a non-linear way, until it reaches saturation. At this point the transformer starts to exhibit different behaviour and it can compromise the proper functioning of the entire grid. Another collateral effect is that one over the generators, as the reactive losses increase; the demand of reactive power is greater. The generators must be able to provide this additional amount of reactive power required by the system.



In the following chapters the different methods to prevent and mitigate the effects of GIC will be amply discussed.

## Chapter 3

# Power system components

Geomagnetic Induced currents can get into the system through any grounded component of the grid, but the main elements affected are the iron core components. Saturation of transformers can be considered as the main cause of all effects that GICs produce in the power system. [8], i.e. transformers are a good starting point for an investigation of risk for the power system regarding GIC.

## Transformers

The aim of the transformers in power systems is to transfer electricity from one AC voltage system to another. Ohm's law states that the current through a conductor between two points is directly proportional to the potential difference across the two points. And the power is directly proportional to the voltage times the current. By raising up the voltage the current will decrease for a constant power flow and, consequently, the final losses due to Joule heating can be diminished. The main principle behind this is the Faraday's law, basic law of electromagnetism which states that a time varying magnetic field will interact with an electric circuit to produce an electromotive force (EMF).

Nowadays transformers have been developed so they need a small amount of exciting current; this current is required to generate the flux for the voltage transformation. The amount and the direction of the flux generated is related to the core material which, in the case of the power transformers of interest here, is steel. The steel core's performance is non-linear and compared to that under the effects of GIC as seen in Figure 4:

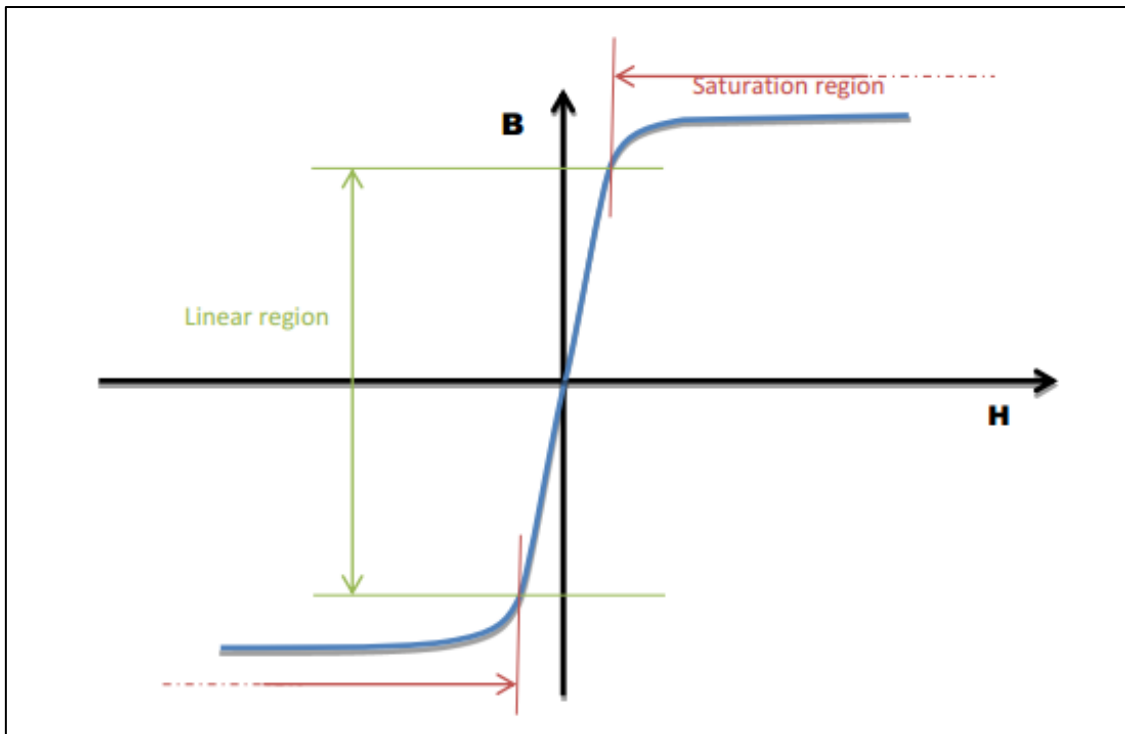

Figure 4 B-H transformer curve [14].

The injection of DC causes a vertical shift of the loop which means a DC component of the magnetic field  $B(t)$ . In the case of a large vertical shift, the transformer can reach its saturation point.

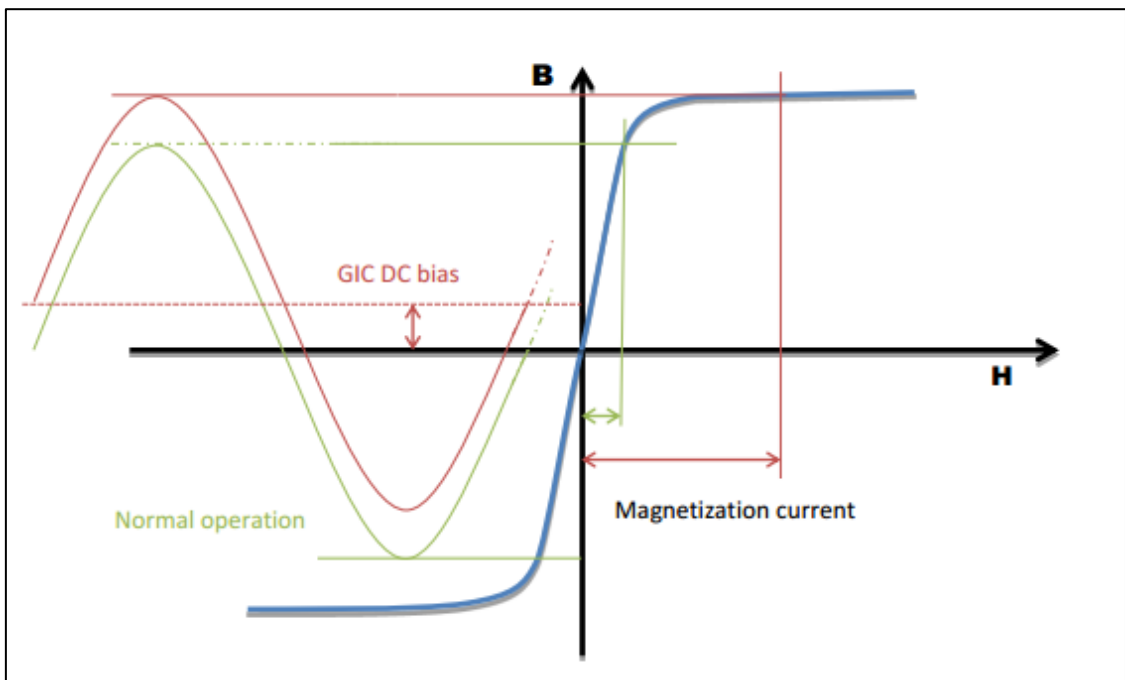

Figure 5 B-H hysteresis curve of TUT with resistive load, 3 cycles shown [14].

Under the effects of GIC, DC current flow through the transformer, it causes a shift on the B-H curve. When operating out of the proper area of functioning it consumes more reactive power than usual. In the case of several transformers being affected by GIC the reactive power demand of the system raises considerably. Voltage drops caused by the larger reactive power demand may affect the normal operation of the system. Simultaneously, the transformer operating near its saturation point changes its size, this change in size states at 100 times a second (at 50 Hz) causing heating and vibration, which at the same time causes noise. [18]

GICs are typically perceived by persons in a transformer station by the noises the transformer causes when vibrating.

**Single Phase**

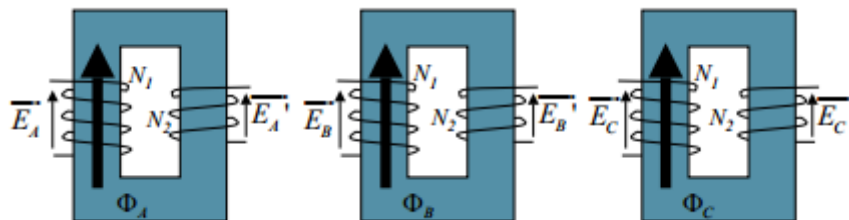

Figure 6 Three single phase transformers [10]

In the case of three phase three single phase transformers, the flux will flow through each one of the transformers; therefore the path it follows is easier as it goes through an iron way (less resistance than air path)

**Three legged Transformer**

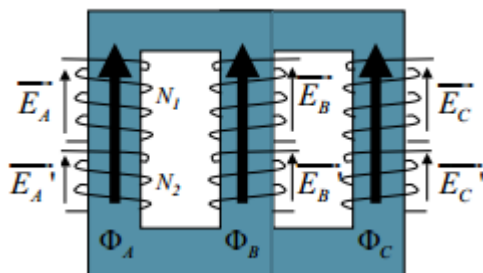

Figure 7 Three legged transformer [10]

DC flux impressed in the windings is in the same direction for all legs, therefore the flux will flow through the zero sequence flux (ZSF) path. In the case of three-phase

three-leg constructions, the ZSF goes outside the core, flows through the air gap and tank and returns to the core.

### **Five legged transformer**

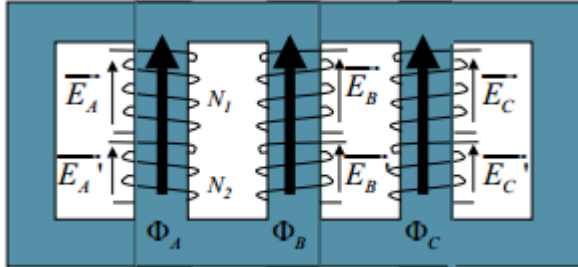

Figure 8 Five legged transformer [10]

For five-leg constructions, the lateral legs act as return paths for ZSF. As long as they do not saturate, the air-paths and the tank will have no considerable effect. For high level of GIC the lateral legs saturate and part of the flux flows outside the core through the oil and the tank leading to increased losses and the temperature rise in the tank.

### **Three-phase Shell Transformer**

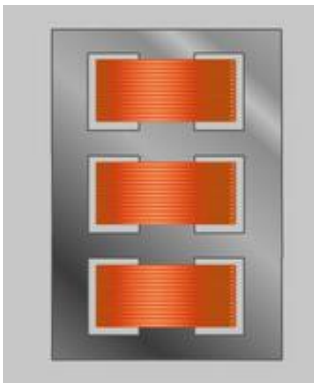

Figure 9 Three-phase shell transformer [5]

Three phase shell transformers act like single phase transformers as the return path for ZSF are the outer legs of the transformer, that makes it easy for the currents to circulate and therefore it is not a good transformer when in events of GIC.

## **Autotransformer**

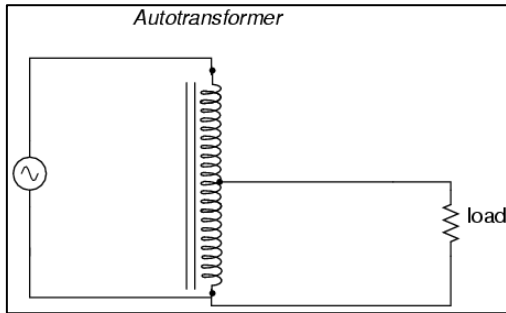

Figure 10 Autotransformer [12]

In autotransformers some GIC current can flow through the series (common) winding into the lower voltage network and terminate at other transformers and substations.

## **Blocking devices**

Certain mitigation strategies can be implemented through the application of certain devices that block or diminish the flow of geomagnetic induced currents in a power grid. Operational modifications can be considered, but the state of the system operation may constrain the efficacy of the ability to mitigate the failure and restore the system to its proper functioning. As a result, the whole infrastructure will generally be more reliable in reducing GIC-based threats to the power grid. [14]

## **Capacitors**

The Geomagnetic current that flows through the grounding of the transformer will be blocked if a low frequency capacitor is connected, in a simple two bus system it would be sufficient to block all GIC flows; however in real grids the circuit would consist of multiple loops and capacitors in all substations would be needed to block all GIC. [14] This will be checked in the following chapters.

These devices operate in lower voltages and are conceptually smaller and simpler. Therefore they will be cheaper than those needed for transmission line series. This is because they are mainly at lower potential and do not carry three-phase load current [14].

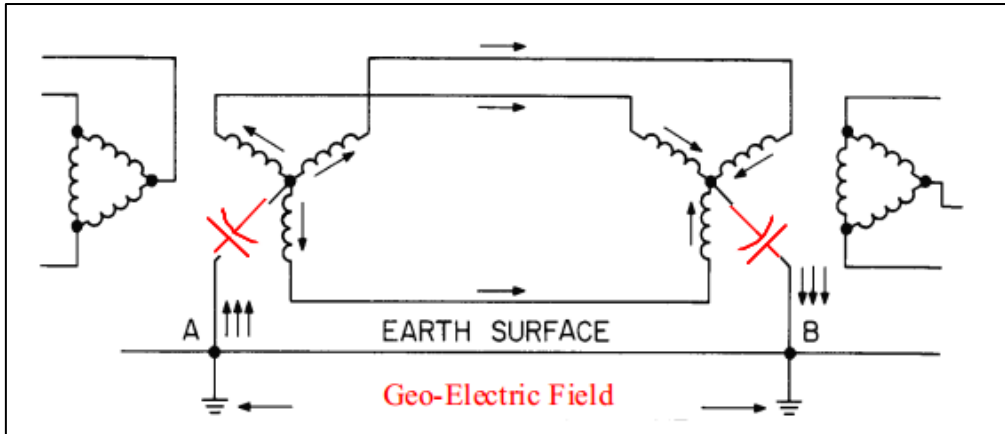

Figure 6 low voltage capacitors connected to ground of transformers [16]

## Grounding resistance

Low ohmic resistors applied on the grounding of the transformer would reduce the flow of GIC. These would be applied in the grounding of the transformers as shown in Figure 7. While the flow of GIC would not be totally impeded, the induced current that flows through the transformer will be lower due to the larger resistive impedance. [14]

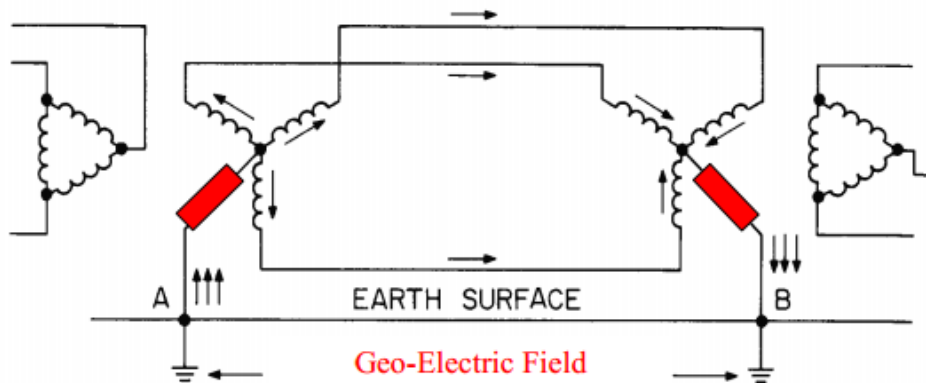

Figure 7 low ohmic resistors connected to ground of Transformers [16]

## Chapter 4

# Modelling Geomagnetically induced currents

As mentioned before, the sun emits charged particles that may reach the Earth, in event of a solar storm this interaction becomes stronger and it induces disturbances in the magnetosphere of the Earth. This GMD drive induced currents along the electric systems. In the chapter to follow it will be explained the electric modelling of the GIC created by geomagnetic disturbances.

## From GMD to induced currents

As explained before the disturbances caused in the magnetosphere of the Earth due to solar activity have the potential to induce currents. According to the Faraday's law, states that the voltage induced in a closed circuit is directly proportional to the speed with which changes in time the magnetic flux through any surface with the circuit as edge [7]:

$$\oint_C \vec{E} \cdot d\vec{l} = -\frac{d}{dt} \int_S \vec{B} \cdot d\vec{A} \quad (1)$$

Where, as indicated in the figure:

S is a surface bounded by the closed contour C.

$\vec{E}$  is the electric field,  $\vec{B}$  is the magnetic field.

$d\vec{l}$  is an infinitesimal vector element of the contour C.

$d\vec{A}$  is an infinitesimal vector element of surface S. If its direction is orthogonal to that surface patch, the magnitude is the area of an infinitesimal patch of surface.



The disturbance makes the Earth's magnetic field go through severe fluctuations. A non-uniform geomagnetic storm profile, characterized by the rate of change of the magnetic field density vector,  $B$ , in units of nT/min, serves as an input to the model.

The main interaction between the magnetosphere of the Earth and the geomagnetic disturbance is assumed to occur 250 km above the surface of the Earth. By integrating the rate of change of the magnetic field density vector over the differential area, the induced geoelectric field can be obtained.[7]

To calculate the GMD-induced voltage on transmission line  $k$ ,  $U_k$ , the electric field is just integrated over the length of the transmission line [8].

$$U_k = \oint_C \vec{E} \cdot d\vec{l} \quad (2)$$

In case that the electric field is uniform along the transmission line, in this project it will be assumed uniform field, the expression above can be simplified by splitting into two terms according to its coordinates

$$U_k = E_{k,N} \cdot L_{k,N} + E_{k,E} \cdot L_{k,E} \quad (3)$$

when expressed in regular coordinates, or if polar coordinates are used:

$$U_k = E_k \cdot L_k \cdot \cos(\theta_{k,E} - \theta_{k,L}) \quad (4)$$

In (3)  $E_{k,N}$  is the electric field direction north (V/km) over line  $k$ ,  $E_{k,E}$  is the electric field direction east (V/km),  $L_{k,N}$  is the distance of the line direction north (km), and  $L_{k,E}$  is the distance direction east (km). In (4)  $E_k$  is the magnitude of the electric field (V/km),  $\theta_{k,E}$  is its compass direction in degrees (with north defined as 0 degrees), the distance between the two terminal busses of the line is  $L_k$ , and  $\theta_{k,L}$  is the compass direction from the substation  $i$  to the second substation defined as  $j$ . [8]

As an example fictional busses will be used to illustrate the calculation of the induced electromagnetic force. A supposed constant field of 2V/km will be used in the application of the formulas. The fictional coordinates represented in both longitude and latitude will be based on different busses of the Swedish and Finish grids and shown in Table 1:

Line	From Bus (lat, lon)	To Bus (lat, lon)
1	(55,13)	(58,12)
2	(56,14)	(57,16)
3	(58,12)	(63,15)
4	(60,25)	(64,28)

**Table 1** Coordinates for different busses for case example.

Two sorts of calculations will be done for the induced voltage, The spherical law of cosines and haversine, the second takes into account the fact that the Earth is round, it is, therefore, more accurate. This error is due to the flat projection of the Earth, for preliminary studies this approach is valid. Both results will be shown in the table 2 depicted below:

Line	Distance [km]	Distance (hav) [km]	Error [%]	Induced Volts [V]
1	339,167 km	336.96 km	0.655	678,4
2	165,610 km	163.996 km	0.984	331,2
3	579,576 km	580.808 km	0.212	1159,2
4	471,418 km	465.104 km	1.3575	942,8

**Table 2** Calculation of distances and voltages for case example.

The distance that has been found using the spherical law of cosines doesn't differ too much that that found using the haversine equation. This approximation is reasonable for shorter distances (under 1000 km) but for longer distances it is needed to use the haversine equation.

The calculation of the induced volts in this case come from the formula explained before. It is the multiplication of the distance for the electric field. As the electric field is 2 V/km the induced voltages per line (in volts) will be 2 times the distance (in km) of the said line.

# GIC Power Flow Modelling

The previous explanation can be used to define the electromagnetic force induced in a circuit. As the induced currents are quasi-direct current it can be calculated by Ohm's law:

$$V = G^{-1} \cdot I \tag{5}$$

Where V is the voltage vector for every node of the system, G the matrix of admittances between the respective nodes of the grid.

The vector I models the impact of the GMD-induced electric fields as Norton equivalent dc current injections. Two main methods have been proposed for representing Geomagnetic Induced Currents in the power grid: either as dc voltage sources in the ground in series with the substation grounding resistance or as dc voltage sources in series with the transmission line resistances [8].

## 4-bus test system

The first case to study will be the shown in Figure 7, the electrical system to be used is made up of four buses, connecting two generators, two transformers and the transmission line between them.

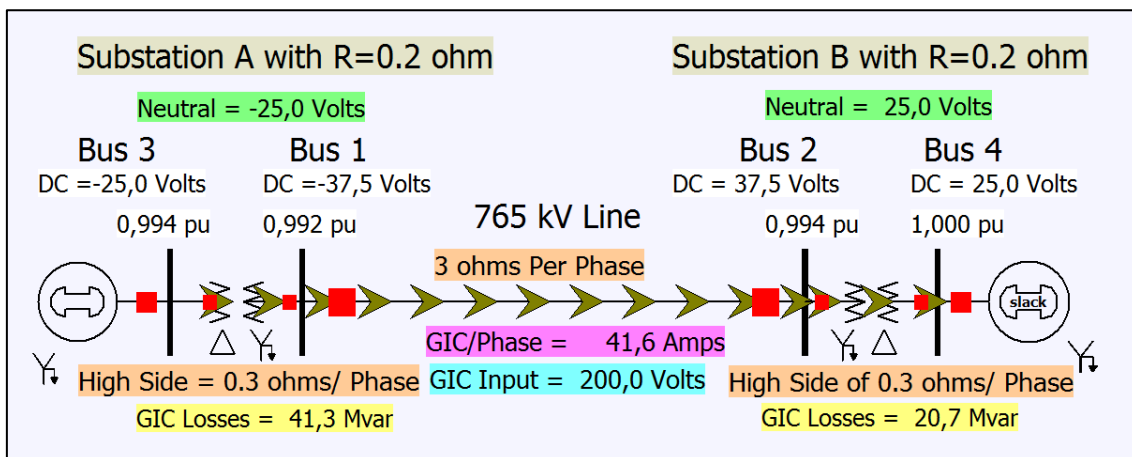

Figure 11 4-bus test system [6].

As a sketch of the previous system the picture below, Figure 8, depicts the electric path the GIC currents are following. The three-phase system divides the line into three different lines with the same resistance and the same induced voltage per phase. The system will close in the grounding of the substations; the grounding of the substations is set at voltage zero, i.e. the soil.

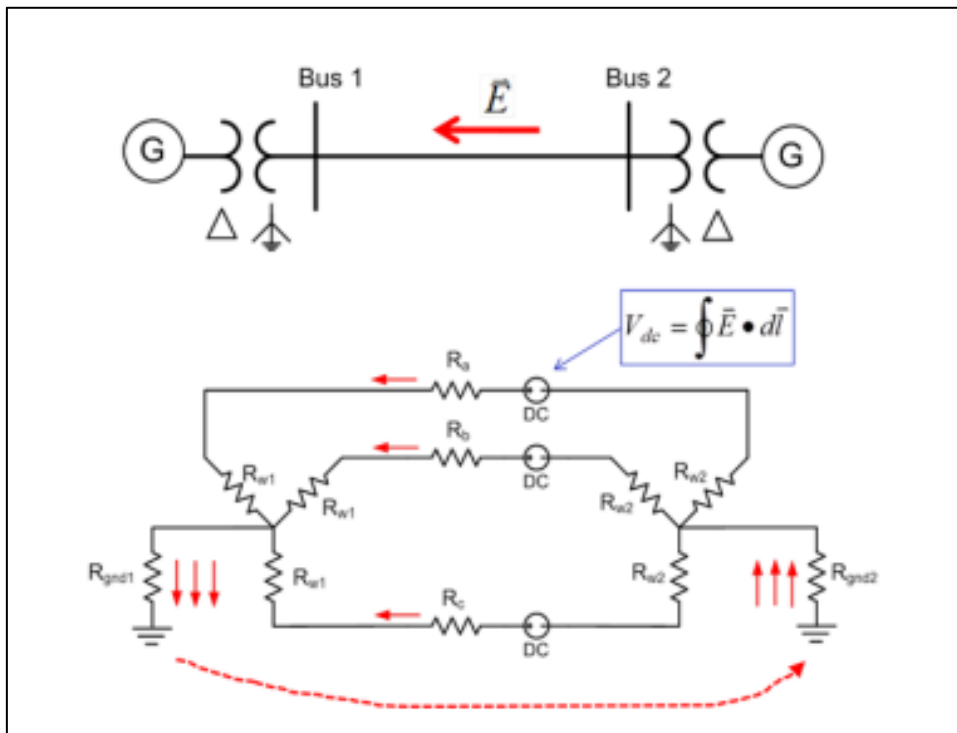

Figure 8 GIC flow in sample case [6].

The GMD induces a current in the system according to the resistances on the elements of the circuit; as the frequency of the GICs are very small, around (0.0001 Hz) it can be assumed that they are direct current, and therefore, the reactances of the circuit can be neglected when calculating the GIC currents. The system works electrically as a voltage direct current source. The current will follow the resistance path through the transformers and generators until ground and it will return for the other side of the circuit.

This system is really simple, and as long as there is no load on it, all the power flow is the induced current due to the GIC field. The base case for this system will be a 765 kV line, the rest of the details are explained below. The system has been tested under the influence of a 1.17V/km electromagnetic field. The transmission line between the buses one and two is 170.8 km long (yielding 200V) and has a per phase resistance of 3

$\Omega$ . The brown arrows represent the direction and magnitude of the sum of all three phases' flow of GIC current along the system.

The first simulation is an example of the disturbances that GIC currents may cause in an electric system. The resistances of the high side of both transformers are  $0.3\Omega/\text{phase}$ , and the grounding of the generators has a resistance of  $0.2\Omega$ . As the system is a three-phase one and the corresponding resistances are in parallel, thus gives the total resistance as  $(3/3)=1\Omega$  for the line and  $(0.3/3)=0.1\Omega$  for both transformers.

The GIC flow can be calculated solving the dc system as explained before.

$$I_{GIC,3phase} = \frac{200 V}{(1 + 0.1 + 0.1 + 0.2 + 0.2)\Omega} = 125A$$

The DC current is 125 A or 41.7 A/phase

The DC magnitudes can easily be calculated at this point, if we consider the resistances of the different elements that compose the grid:

$$V_{DC,bus3} = 125A \cdot 0.2\Omega = 25V$$

$$V_{DC,bus1} = 125A \cdot (0.2 + 0.1)\Omega = 37.5V$$

And respectively it can be done with all the busses of the system, it can also be done using an admittance matrix, which is more convenient for larger systems.

As we can see, the reactive losses also produce a drop in the voltage; the drop will be higher the higher the reactive losses are.

As long as there is no load in the system, the generators provide only the required power for the transformers in terms of losses; this is a high reactive power and very small (in comparison) active power.

The two transformers are grounded; their configurations are Gwye – Delta. This will be of vital importance when applying blocking devices, as the transformers are grounded, the GIC currents have a path to flow to earth.

In this case, the input used is 200 Volts, which is the induced voltage created by a 1.7 Volts/km in a 171 km line, calculated as before.

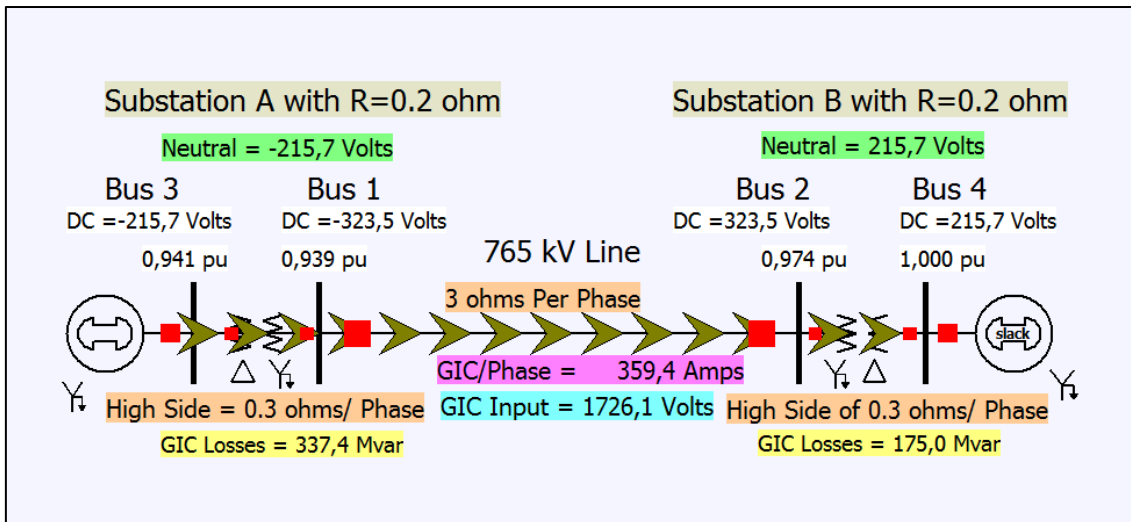

Figure 12 4 bus test system under 10 V/km GIC.

Keeping the same parameters, only modifying the maximum field of GIC (up to 10 Volts/km), and the new simulation changes. The losses are higher, as explained before, most of the losses are reactive power; therefore, the generators don't have to provide much additional active power. The losses of reactive power could be compensated by installing shunt devices such as capacitors in the transformers.

If the field of GIC increases, the saturation of the transformers can be reached, saturation increases reactive losses and excessive such losses may cause a blackout preventing the proper operation of the system.

The flow of electricity can also vary if the direction of the GIC field changes, in this system there is no load, therefore the energy provided by the generators is consumed in the losses, if the GIC field is rotated 180°, the electricity will flow in the other way.

## Chapter 5

# Parametric analysis

One aim of this project is to compare different ways of eliminating GIC and study the different mitigation strategies. As GMD events mainly occur either at high or low latitudes due to the magnetic poles of the earth, it is reasonable to compare between countries located to the north, three countries that have studied are North America, Sweden and Finland; the last two are located near the arctic circle, and North America is a very big continent, so the northern parts lay in a territory susceptible of being under the effects of GMD in certain occasions. Then it will be discussed the different configurations of transformers and blocking devices used.

## Different countries

### *North America*

In North America, the typical transformer configuration is a shell core transformer. The United States is a much bigger country than the other two, but the GIC events occur mainly in the northern part of it, and also Canada, where the Québec event took place. Additionally, the different sections of the grid are not totally interconnected, that makes North American grid a conglomeration of nearly independent power grids.

### *Sweden*

In Sweden it is common to use a five legged transformer. If we look at the map of Sweden, it is noticeable that it is a long country. Series capacitors are used in the major north-south lines to increase transfer capacity. These also block Geomagnetically Induced Currents. Therefore, the line length used in the case study will be that of the West coast to East coast distance (approximately 300 kilometres).

### *Finland*

Finnish engineers claim their system to be immune to the GIC currents, the typical configuration used there is three-legged transformer [9]. Finland is a country located in latitude above parallel 60° and even part of it lies northern than the Arctic Circle. Therefore, GIC events are expected to occur frequently. Although the design of the

transformers used there is meant to be able to handle all possibly GIC events there will blocking devices be used in Finland as well.

## Comparison between transformers

In order to start the comparison between the three countries parameters need to be established. The circuit will be the same as in the previous simulation, in this case the voltage level will be 765kV and no blocking devices will be used. The comparison will be between the configurations of the transformers in the 3 countries. The reactive losses are meant to heighten gradually along with the increase of GIC field, and so the transformers will reach their saturation point. The critical transformer is expected to be the first one (Busses 1 and 3) as the other transformer is located next to a slack bus which sets the voltage to 1 p.u. at any time.

The simulations will be done with different fields of GIC, starting from 0 V/km to field levels that causes blackout in each case, the preliminary observations point out that the Finnish system will be the most reliable in case of GIC events according to its transformers (3-legged). Even if the measurements of the last years indicate that the biggest field that can occur is 5 V/km [3], the simulations will be done up to blackout for the three different configurations of transformer.

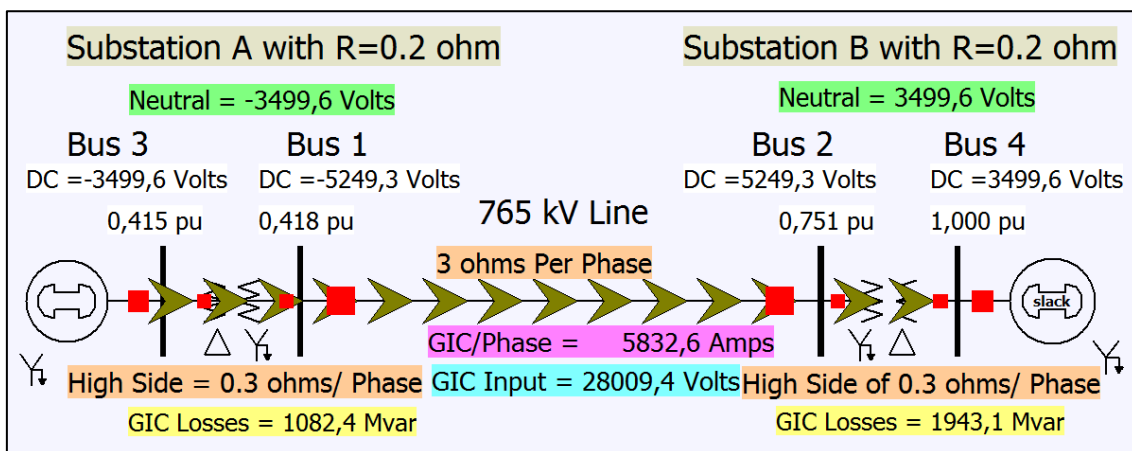

Simulations with 3-legged transformers and 164V/km GIC.



## Study of Reactive losses

The following simulations will be done under different GIC conditions, for the same system it will give different induced currents. Therefore this will produce reactive losses in the transformers due to saturation of the core.

GIC level [V/km]	USA Trans 1 [Mvar]	USA Trans 2 [Mvar]	SWE Trans 1 [Mvar]	SWE Trans 2 [Mvar]	FIN Trans 1 [Mvar]	FIN Trans 2 [Mvar]
0	0	0	0	0	0	0
10	410,7	430,8	97,6	276,5	43,1	122,5
20	745	827,8	194,9	545,3	85,8	243,4
30	999,7	1189,9	294,9	807,3	128,5	362,8
40	1167,7	1514,7	401,5	1063,8	171,2	480,8
50	1227	1795,1	521	1317	214,3	597,4
60	Blackout!	Blackout!	666,7	1571,1	258	712,7
70			893,1	1843,5	302,7	826,9
80			Blackout!	Blackout!	348,7	940
90					396,4	1052,2
100					446,6	1163,8
110					499,8	1274,9
120					557,3	1385,9
130					620,7	1497,4
140					692,9	1610,3
150					780,2	1726,5
160					904,3	1853
170					Blackout!	Blackout!

Table 13 reactive losses vs GIC field for the two transformers in the systems representing the three countries

The reactive losses in both transformers have been recorded in this table; it is easy to realize that the losses in the system of the United States increase faster than the other two per unit of GIC field. The most reliable system is the Finnish one, as expected; it can resist twice the amount of GIC field without collapsing. In all cases the critical transformer is the second one, the one in the bus opposite to the slack; this bus is also the one with greater drops of voltages.

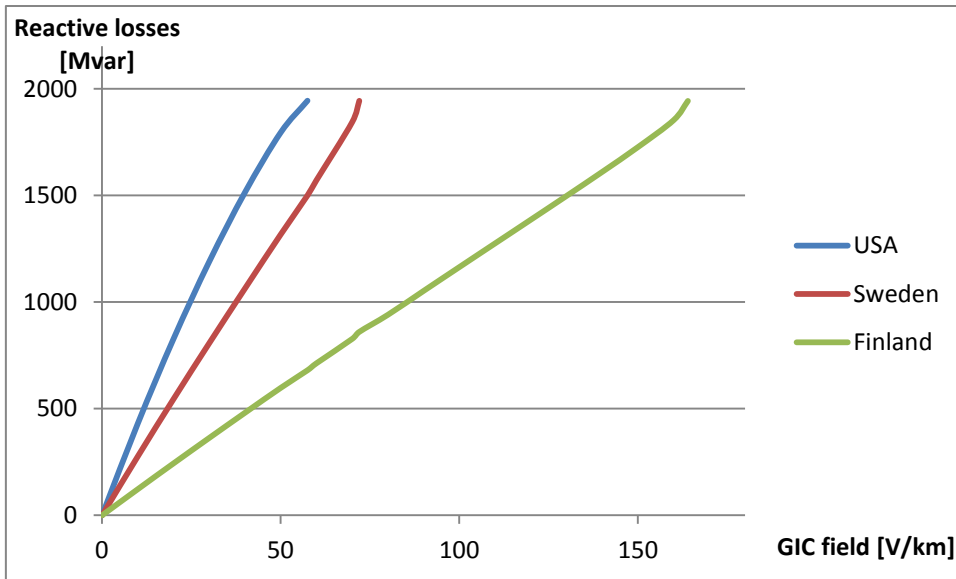

Figure 14 graph reactive losses vs GIC field between countries, transformer 2.

In the previous graph it can be observed that the reactive losses increase on a linear way as the GIC field increases except when approaching blackout. The blackout point is approximately the same for all three systems; this is due to the fact that is the same transformer (same resistance, reactance, nominal power, etc.) in all three cases, the only difference is the configuration. In all cases the voltage is 0.418 p.u. in the bus 3, this value of voltage is unacceptable in an electric system, even a not so high level such as 5 V/km of GIC field might jeopardize the stability of the entire system.

GIC max [V/km]	USA Trans 1 [Mvar]	USA Trans 2 [Mvar]	SWE Trans 1 [Mvar]	SWE Trans 2 [Mvar]	FIN Trans 1 [Mvar]	FIN Trans 2 [Mvar]
57,5	1097,6	1944,2				
72			1088	1943,7		
164					1082,4	1943,1

Table 15. Maximum GIC field for each country. 2 transformers per country.

As a conclusion it can be noticed the strong relation between the type of the transformer and the robustness of the system to GIC events. The one that performs the best is the three legged one, the one typically used in Finland. The other two are far behind regarding max field of GIC that can hold. The five legged transformer, typically used in Sweden can hold up to 72 V/km, being the second better in this test. The worse

performing in this case is the shell core transformer, the one typically used in NorthAmerica.

## *Study of voltages*

We have proved that for the maximum values of GIC found in real events all test systems are stable, that means they don't collapse into blackout. As real transformers use also blocking devices, the number already found are conservative values, the real transformers with blocking devices will be able to work without collapsing up to a higher value of GIC. From now on the research will be focused on the proper operation of the system more than in the stability of it.

As previously inquired, the maximum GIC event that may take place is about 5 V/km, that is why once the threshold is found out for the blackout it is necessary to take a closer look into the lower levels of GIC.

GIC Field [V/km]	V Bus 1 [V]	V Bus 2 [V]	V Bus 3 [V]	V Bus 4 [V]
0	1	1	1	1
1	0,99	0,993	0,993	1
2	0,982	0,989	0,985	1
3	0,974	0,986	0,976	1
4	0,965	0,982	0,968	1
5	0,957	0,978	0,959	1
6	0,949	0,975	0,951	1
7	0,94	0,971	0,943	1
8	0,932	0,967	0,934	1
9	0,923	0,963	0,926	1
10	0,915	0,96	0,918	1

Table 16 Three phase shell transformers voltage drop, typical US transformer.

GIC Fiels [V/km]	V Bus 1 [V]	V Bus 2 [V]	V Bus 3 [V]	V Bus 4 [V]
0	1	1	1	1
1	0,992	0,994	0,995	1
2	0,985	0,991	0,988	1
3	0,979	0,988	0,981	1
4	0,972	0,985	0,975	1
5	0,965	0,982	0,968	1
6	0,959	0,979	0,961	1
7	0,952	0,976	0,954	1
8	0,945	0,973	0,948	1
9	0,939	0,97	0,941	1
10	0,932	0,967	0,934	1

Table 17 5 legged core transformers voltage drop, typical Swedish transformer

GIC Fiels [V/km]	V Bus 1 [V]	V Bus 2 [V]	V Bus 3 [V]	V Bus 4 [V]
0	1	1	1	1
1	0,996	0,996	0,998	1
2	0,993	0,994	0,995	1
3	0,99	0,992	0,993	1
4	0,987	0,992	0,989	1
5	0,984	0,99	0,987	1
6	0,981	0,989	0,984	1
7	0,978	0,988	0,981	1
8	0,975	0,986	0,978	1
9	0,972	0,985	0,975	1
10	0,969	0,984	0,972	1

Table 18 3 legged core transformers voltage drop, typical Finish transformer.

The latest comparison between voltage drops was done between the voltage drops of the third bus, thus being the entire voltage drop between the ends of the four bus system. As it happened with the reactive losses, the three legged shell core transformer is the one with higher drop, which works perfectly under no GIC field but under GIC field it can threaten the stability of the entire system.

Reactive losses and voltage reduction are relevant in this work, since the reactive power will indicate us the need of utilization of capacitors, the voltage will show the correct operation of the distribution system.

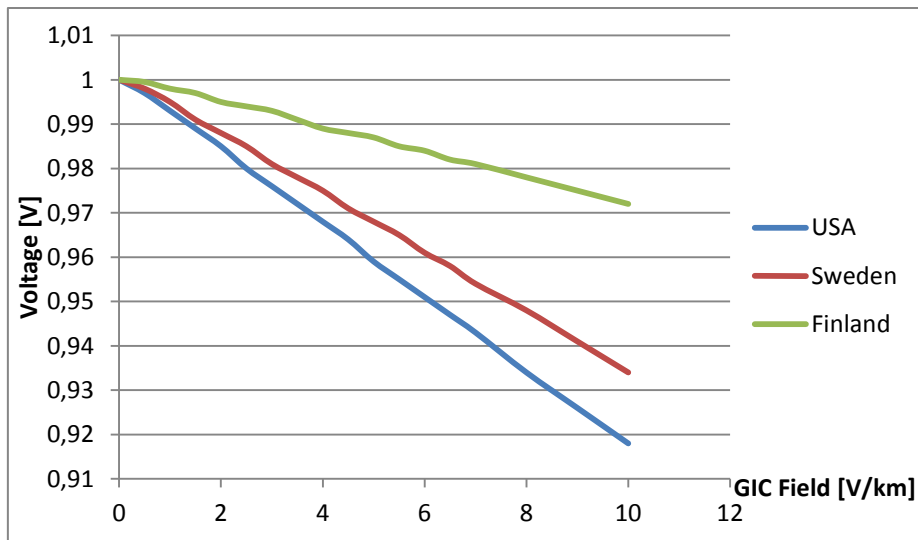

Figure 19 Comparison between countries, Voltage reduction.

As a conclusion of the first comparison, what has been done without using blocking devices, it can be concluded that the system of the USA (three legged shell core) is a priori worse than the other two in terms of stability. As GIC increases the voltage drops faster than with the other transformers and the reactive losses increase faster. Although it is not realistic to discuss about blackout in this system because the usual levels of field are much below the blackout threshold in all the cases; the shell core transformer system will cause collapse before the other two. The Finnish solution seems to be the best in this comparison, both voltage drop and reactive losses are better with the three legged transformer system; this meaning greater margins to blackout.

All of the done comparisons are still conservative, because the lack of blocking devices is not realistic; in the next pages the use of these devices will be taken into account. This first system is simple and resilient, it can manage great amounts of GIC levels without collapsing, but it is not only collapsing what it is meant to avoid in the system.

From both economic and technical points of view it is necessary to keep the magnitudes in reasonable values, as seen the reactive losses increases, this means that the generators must provide more energy than necessary, wasting money and energy. As the voltage drops also the losses increase, the current increases for the same power and that makes the losses for heating increase. The voltage and the reactive power must be maintained inside a certain range.

The next comparison will be done applying blocking devices to the said system, that makes the simulation more realistic and, at the same time it makes the system safer. Blocking devices can block partially or totally the induced currents.

## Different blocking devices

The same test will be passed using blocking devices.

The use of blocking devices will make the system more reliable against GMD events; the induced currents due to electromagnetic disturbances will be lower because of the higher resistance of the whole circuit.

In order to compare the different blocking devices, the test will be done in different stages for different dimensions. Every kind of core transformer will be proved under various conditions of GIC field.

## *Grounding resistance*

In the software tool that is currently used there is no possibility to explicitly define grounding resistance of the transformer. Therefore the simulations will be done modifying the grounding of the substations. This procedure is electrically equivalent as it replaces one series resistance by another of the same value. The previously done simulations all had a ground resistance of  $0.2 \Omega$ , and when this grounding resistance increases, the DC induced current that flows along the transmission line will decrease and, consequently, the losses will decrease as well and the voltage drop won't be so severe as before.

As done before, the following figures will focus on the reactive losses and the voltage drop for the different configurations of transformers. The first transformer to be tested will be the three legged transformer, which is used in Finland. In the previous test it gave the best performance. It is expected that the losses will decrease but not as much as in the case of the other transformers.

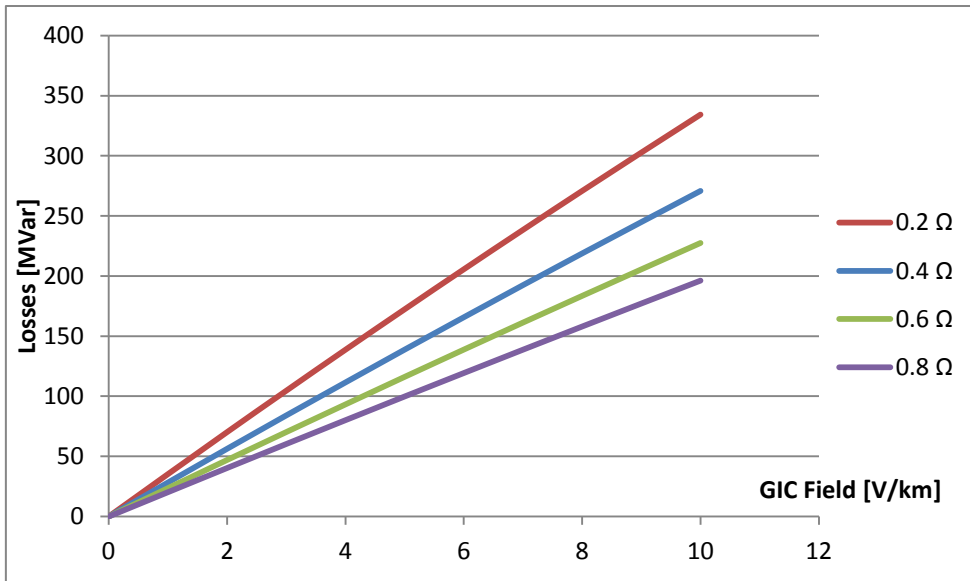

Figure 20 Reactive losses for different grounding resistance in a three legged transformer.

As expected, the reactive losses for those systems in which it has been applied a grounding resistance are lower; the greater the grounding resistance, the lower the losses will be. If the resistance increases as much as possible, then it will become an open circuit, such as with the capacitor, this has some other disadvantages because of earth faults. This kind of transformer, three legged transformer was the one with a better performance in the previous test, it has been proved that using a blocking device the losses can greatly decrease, up to 30%.

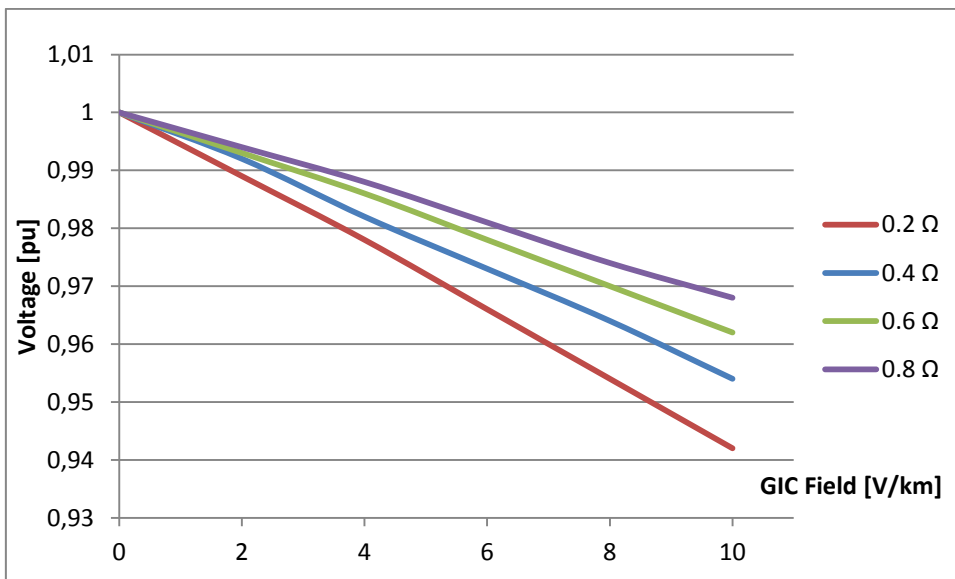

Figure 21 Voltage drop for different grounding resistance in a three legged transformer.

In the case of the voltage drop happens the same; the greater is the grounding resistance the better the response to GIC field will be. The voltage drop was also the better in the case of the three legged transformer but with a blocking device the voltage drop can decrease up to 40%.

In the following graphs it is depicted the performance of the different configurations of transformers for different blocking devices under different electric fields.

The second transformer to be tested will be the five legged transformer. In the previous simulations the performance was neither the best nor the worst. In the case of the five legged transformer, the one used in Sweden, the performance against electric field improve when a blocking device is applied. It can be noticed that when the grounding resistance is increased the reactive losses don't decrease at the same rate. This means that a maximum can be reached, the theoretical maximum will be the same as a capacitor; this is an open circuit, in which no DC current could flow.

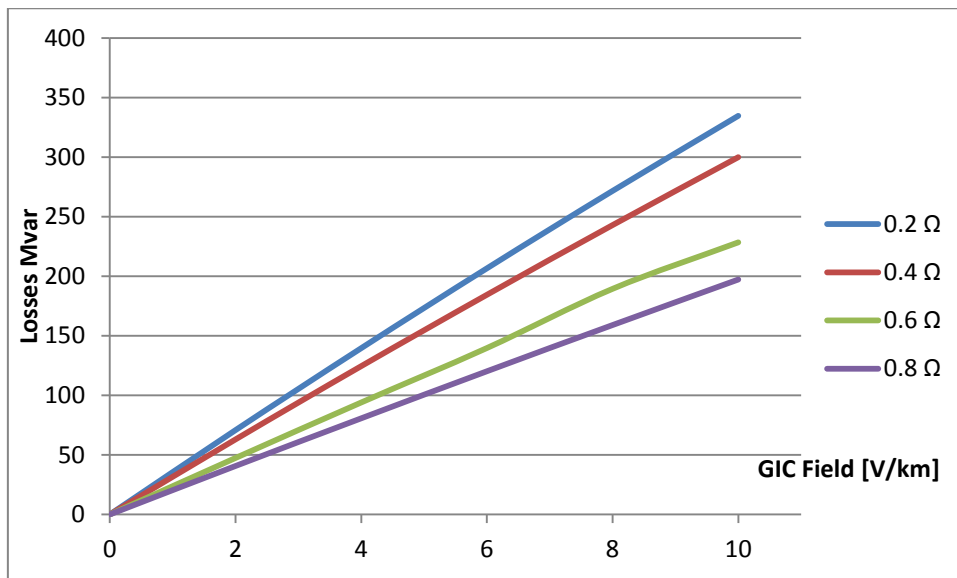

Figure 22 Reactive losses for different grounding resistance in a five legged transformer.



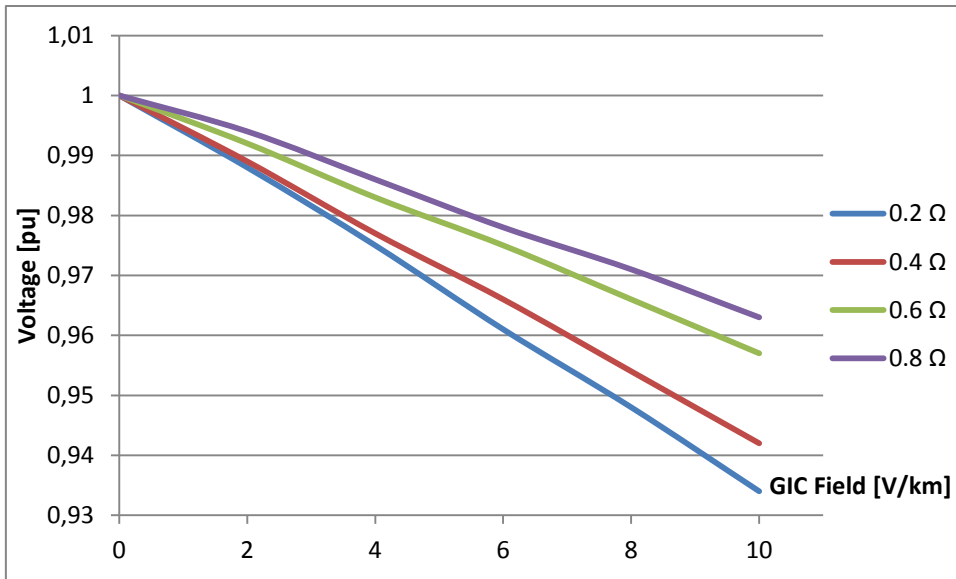

Figure 23 Voltage drop for different grounding resistance in a five-legged transformer.

The voltage drop is also smaller with a greater grounding resistance, but the final performance is still worse than with the three-legged transformer.

In the case of the three-legged shell core transformer depicted below both magnitudes also improve their performances. It is important to point out that this transformer was the least robust in case of GMD events.

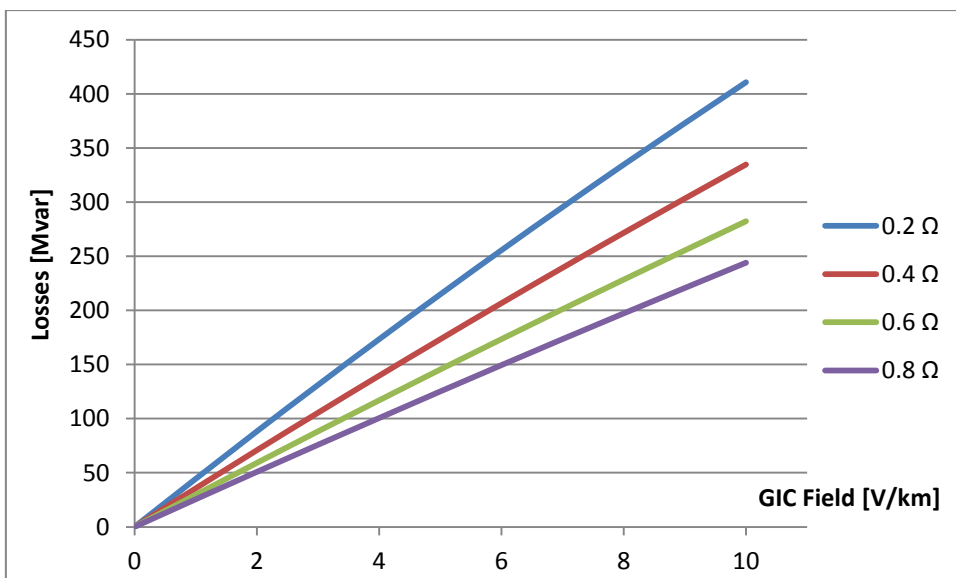

Figure 24 Reactive losses for different grounding resistance in a three-legged shell transformer.

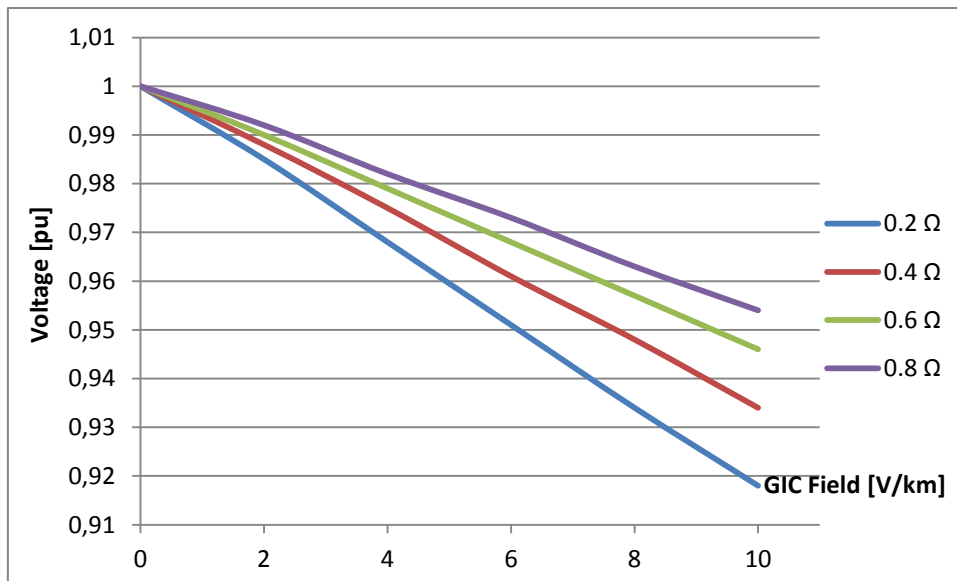

Figure 25 Voltage drop for different grounding resistance in a three legged transformer shell.

The final conclusion is that every system has improved its performance after applying a grounding resistance in both transformers. The bigger the resistance is the less reactive losses the systems will have, and the smaller will be the voltage drop. It is expected that at the time of applying it in the greater, more realistic system, these blocking devices will increase the reliability of the entire system with respect to geomagnetic induced currents.

## Capacitor

The software tool that has been used for the simulations does not allow the user to apply capacitors in the grounding of the transformers. The procedure to obtain a similar case was to change the connection of the transformers. The connection now is Ground path delta-grounded wye; with the delta connection the DC current cannot return to ground and no current can circulate, the open circuit then establishes a DC voltage drop between the ends of the transmission line.

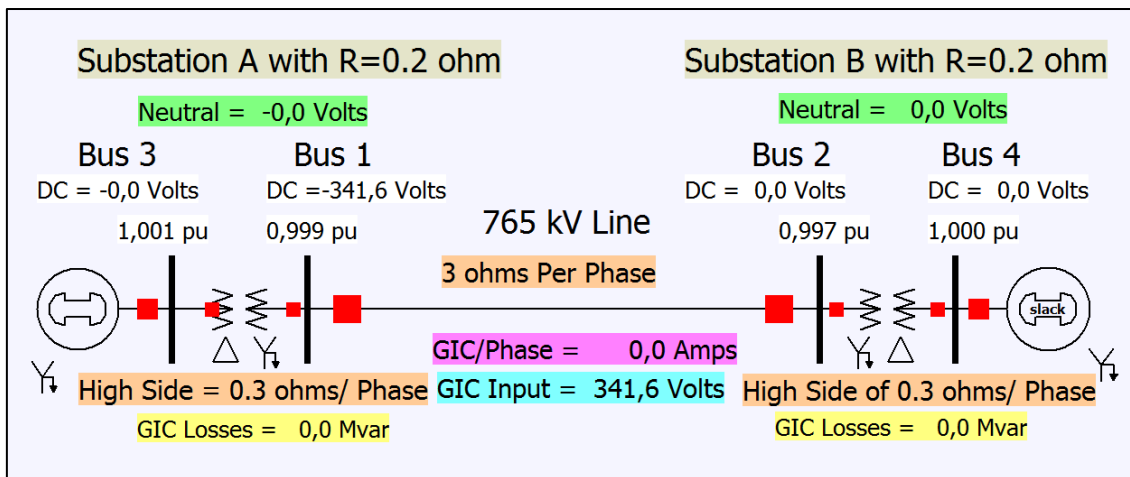

Figure 26 Delta connection working as a capacitor in the grounding of the transformer; delta connection cannot be seen due to the specifications of the software.

As can be seen in Figure 22; the open circuit in the transformer, in this case the transformer with delta connection was the one between buses one and three, prevents from the flow of direct current along the line. All the current in the previous simulations was induced due to the GMD; therefore in this case there is no current flowing. The GMD field can be perceived by watching the voltage in bus one, all the voltage input in the system appears between buses one and two, between the grounding of the transformer in bus 2 (being voltage zero) and the open circuit in bus 1 (being voltage 341.6 V).

As a conclusion, it can be acknowledged that the use of any blocking device improve the reliability of the system.

Since both blocking devices act in different ways, they should be applied in a different manner. Grounding resistances prevent the system of generating induced currents under the same conditions of geomagnetic disturbances while capacitors applied on the grounding of transformers impede the flow of induced currents along the system. The blocking devices will be tested in a more realistic system in the following chapter.

## Chapter 6

# GIC distribution

In order to better study Geomagnetic Induced Currents, the next step will be to test the blocking devices in a bigger and more realistic system. The system will be a twenty bus system with seven generator and nine transformers. The system will be tested under different fields of GIC.

## GIC in a 21 bus system

The system to use will be the following, a 21 bus system comprised in 8 substations, the system has been modelled by PowerWorld [16]. In Figure 23 a geographical draft is depicted with the different substation according to their geographical coordinates.

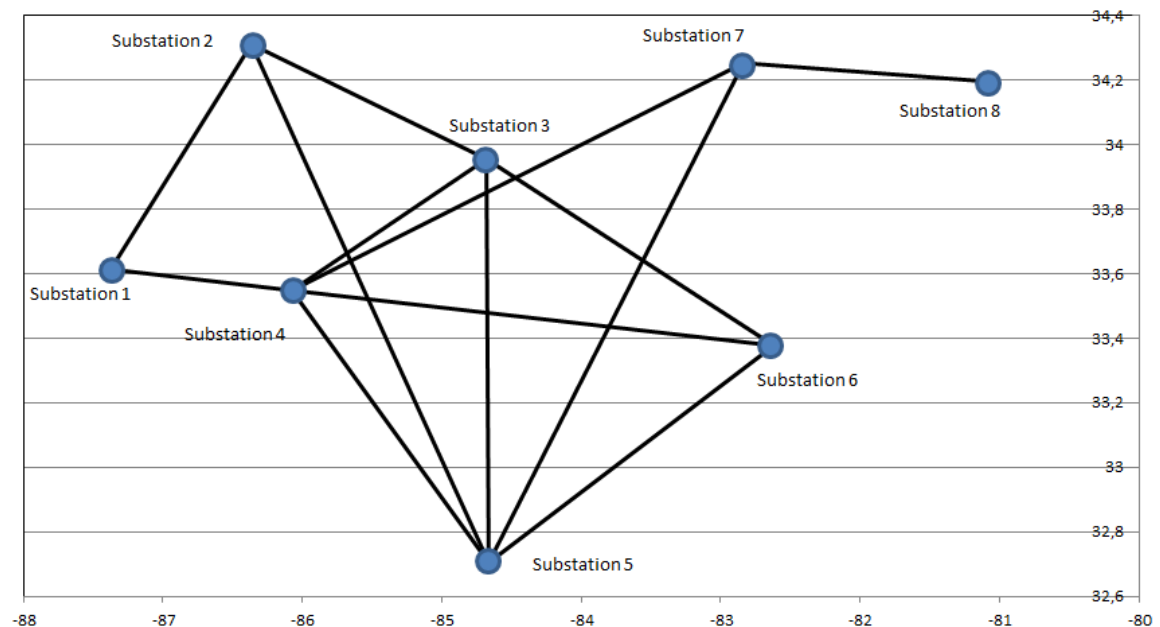

Figure 27 Geographical representation of the 21 bus system

The base system to study will be the one depicted in Figure 24, where the generators are producing active and reactive power to supply the loads at the ends of the different busses. In this base-case figure GIC is set to zero.

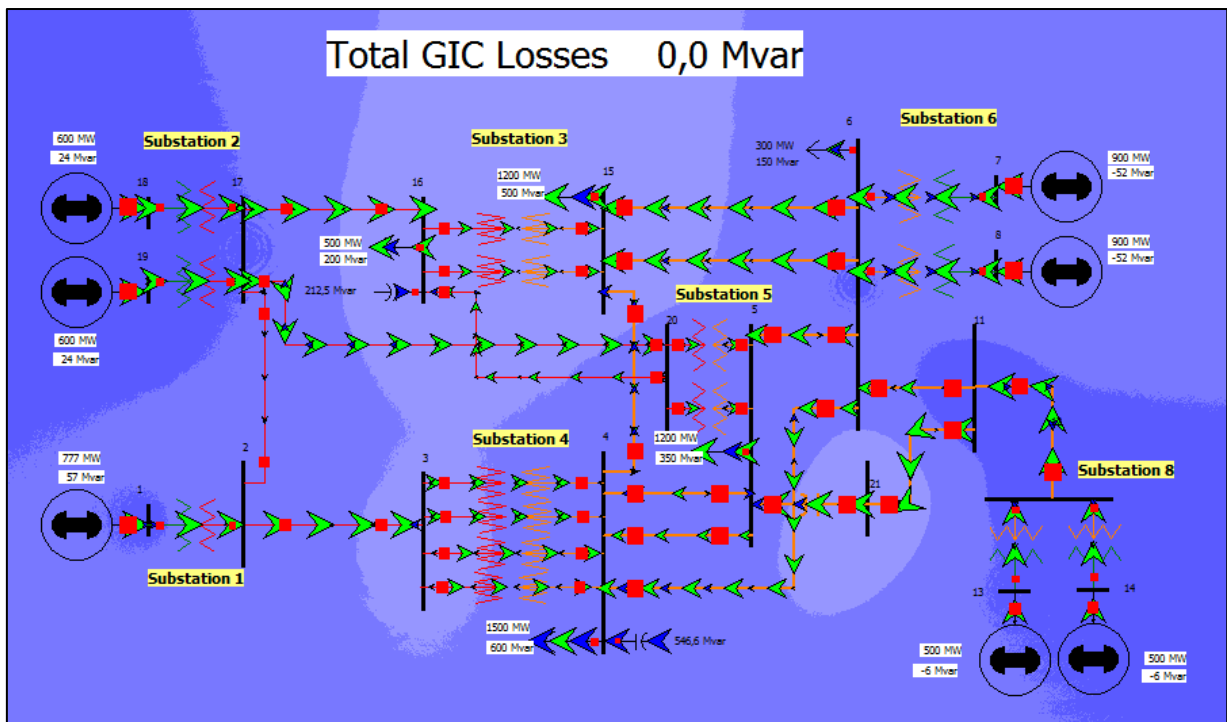

Figure 28 21 bus system under no GIC field

There are five loads that consume mainly active power; there is a component of reactive power that the generators must compensate and two groups of capacitors that will generate reactive power. As long as the electric field increases the reactive losses will rise, the generators will be required to additionally generate the amount of reactive power that the transformers consume due to the GIC currents.

The system has three different levels of voltages, the generators operate at 22kV, the transformers raise the voltage up to 345 kV and 500 kV for transmission. The voltages of the different lines are not meant to affect the GIC, since the induced currents are direct current and the system is alternating current.

The flow of active power along the system (MW) is meant to be approximately constant regardless the Geomagnetic Disturbances, this is because the GIC affect mainly to the reactive power. The active losses in the transformers will be slightly greater with increasing GIC field, but these losses are negligible in comparison to reactive ones.

Nevertheless, the flow of reactive power is expected to change correlated to the induced currents. The greater the currents, the larger the losses in the transformers and, therefore, the flow of reactive power will increase.

This can be solved installing capacitors in specific points of the system, the critical ones. The flow of reactive power along the system will cause variations on the voltages of the different busses. As explained before, reactive power flows from higher voltages to lower ones.

When increasing the electric field, the induced currents will increase and, consequently the reactive flow too. All of this will make the voltage in the different busses decrease, if the voltage decreases too much it can reach untenable levels.

If the low voltages are not restored or if these voltage decrease further, the system can be no longer able to supply load and it will collapse.

The arrows in the picture above represent the flow of active and reactive power, green and blue respectively. As there are no induced currents along the lines, the reactive power is just the necessary to supply the loads that are not supplied by the installed capacitors and the transformers will consume a little amount of reactive power as well; after all, this is not a large amount of reactive power.

The first step in the study will be to increase the amount of GIC field and reckon the critical busses in the circuit, there will likely be areas in the system where the voltage is critically low due to the reactive losses.

Under a GIC field of 7 V/km it can be seen that there are three regions where the voltage drops to not optimal levels, this being 0.95 p.u., those are busses 3, 16 and 21. The red colour indicates low voltage, i.e. the lower being 0.90 p.u., while the blue colour indicates high voltage, i.e. 1.1 p.u. , both compared to 1 pu, which is white colour.

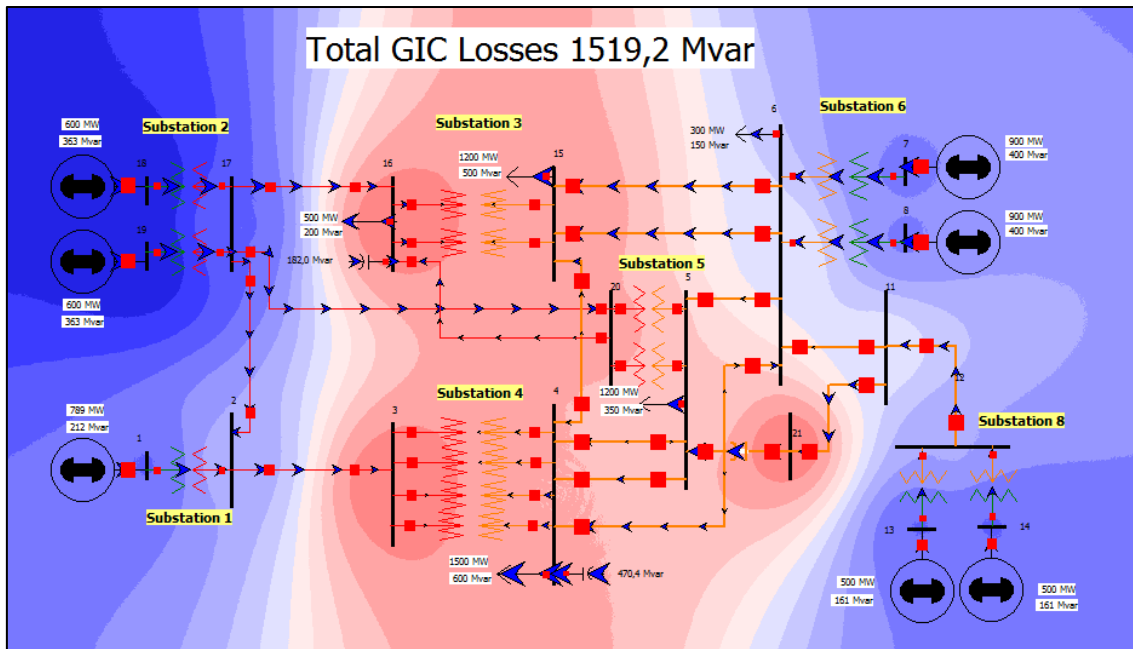

Figure 29 21 Bus system under 7 V/km

The techniques developed in earlier chapter will be applied in the more realistic 21 bus system. First the critical busses will be protected with the blocking devices already explained, grounding resistance and capacitors.

As can be seen in Figure 25, the busses 16, 3 and 21 are the critical ones; the voltage in these busses has dropped below 1 pu, to 0.95. The first attempt will be to ensure the critical busses with blocking devices. Using capacitors in the transformers next to the busses the GIC current will not be able to go through and the reactive losses in the transformers will be less.

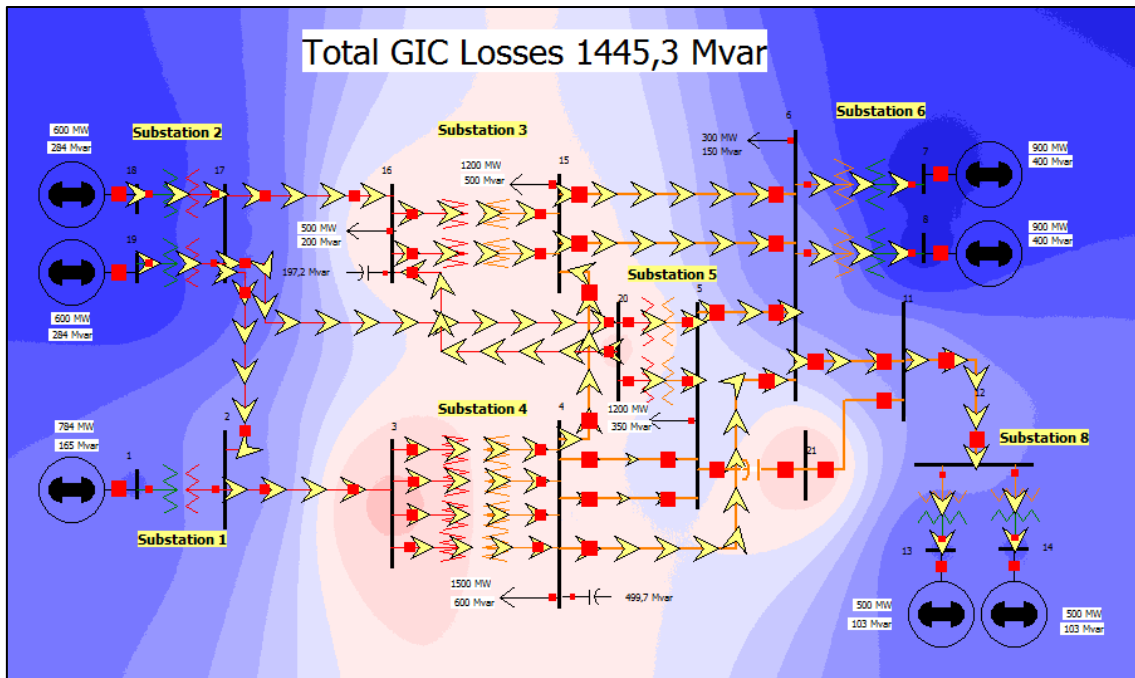

Figure 30 21 Bus system applying capacitors in three buses, substations 3, 6 and 5

Under the same GIC field, it can be noticed that the new has lower overall voltage drop. Capacitors have been applied in the transformers in substations 3 and 4. The new voltages of the busses are higher, close to 1 p.u. which would be ideal, the lowest voltage in this case is 0.97 pu. The total reactive losses decrease although not so much, other elements in the circuit must be taken into account.

It has been proved that the application of capacitors in the transformers of the critical busses make the system more reliable by controlling the critical voltage. Capacitors impede the flow of GIC and, therefore, the reactive power on the busses is not so high maintaining the voltage of the different busses in stable levels. Although this solution is a good solution for the reliability of the entire system, the reactive losses are still high so another way to tackle this problem must be found.

## Changing grounding resistance

By studying the system it can be observed that the GIC flows are different depending on the amount of GMD and the direction of said field. These currents can be larger or



smaller depending on the configuration of the system. As said in chapters above, by modifying the grounding resistance of the different elements it is possible to decrease the induced currents.

In this case, the grounding resistances are in all cases 0.2  $\Omega$ . The induced currents are expected to decrease when this resistance is increased. There should be a consensus about the maximum grounding resistance to be attached. A larger grounding resistance will worsen the performance of the system against asymmetric faults.

The study will be done increasing gradually the grounding resistance of all substations. The resistance by default of some of them is larger than that of other substations, i.e. 0.1 $\Omega$  in substation 6 and substation 5, while substation 4 has 1  $\Omega$ ; this will be taken into account by increasing more the larger ones in the same pattern.

Under a constant field of 5V/km with a direction 90° (Eastwards) the whole system has been tested applying different grounding resistances in the substations. The resistances by default vary between 0.2 $\Omega$  and 0.8 $\Omega$ . The procedure will be to increase these resistances up to 0.8 $\Omega$ . It is expected that all currents will decrease and, consequently, the reactive losses will decrease as well.

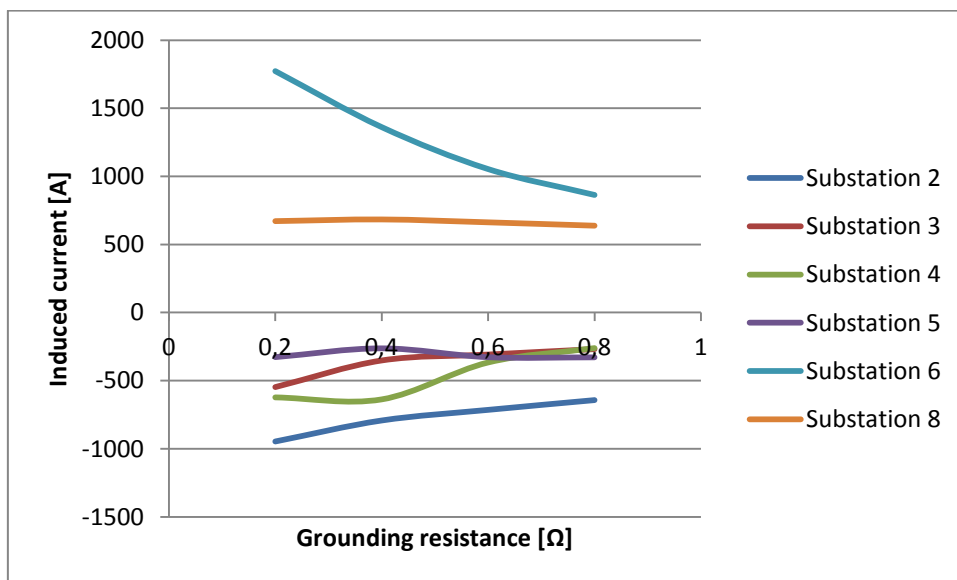

Figure 31 Induced currents in 21 bus system applying grounding resistances

In Figure 27 the variation of the different currents can be noticed. As expected, all the currents decrease their magnitude in absolute value, except substation 5 that does not follow this trend, this is because this substation is in the centre of the net and when

decreasing in other substations it may increase. Applying grounding resistances to a system can make it be more reliable by reducing the consequent induced currents. This blocking device neither improves the performance of any specific device nor ensures the system; it makes the induced currents be smaller as they would have been otherwise.

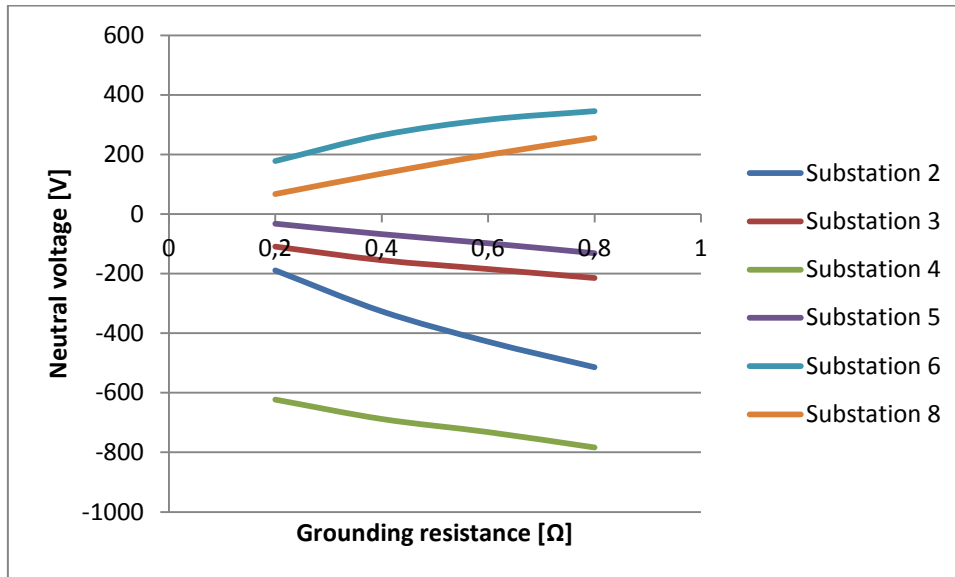

Figure 32 Neutral voltages in different buses when applying grounding resistance

However, as can be seen in Figure 28, the voltages of the substations increase. A priori that might not be a problem since it is the neutral voltage the one that increases and it does not affect the proper functioning of the entire system.

The problem comes when facing asymmetrical faults, a high neutral voltage can make the fault a more severe one, and also it will become more difficult to restore. Neutral DC voltage due to GIC is different from neutral AC voltage due to unsymmetrical fault. That is the reason why a very high grounding resistance cannot be applied; there must be a compromise between the diminishing of reactive losses under Geomagnetically induced currents and the reliability of the system when an asymmetrical fault to ground occurs, as mentioned before, Finnish engineers have found a solution using resistive grounding reactors.

The total reactive losses of the system when applying different grounding resistances can be seen in Figure 29:

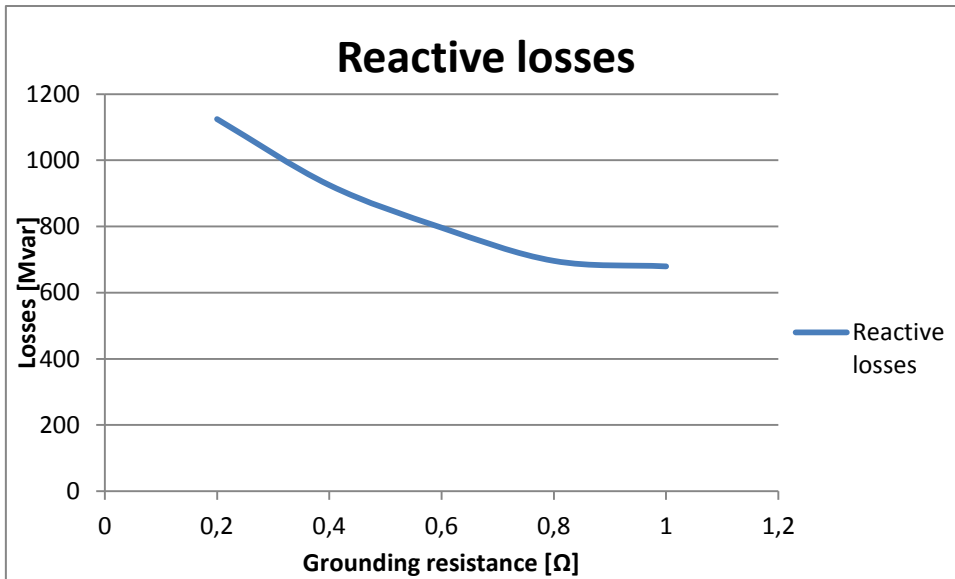

Figure 33 Reactive losses in 21 bus system when increasing grounding resistance everywhere

Over all the reactive losses decrease, meaning that the performance of the whole system has improved. The losses decrease faster in the beginning of the curve and decrease slower when approaching the end of the curve.

The conclusion will be not to apply a very high value of grounding resistance because it could cause problems in case of asymmetric fault and the differential gain is not as great.

## Grounding resistance in different busses

In the chapter before described a study about the application of grounding resistances to the entire system, here the focus is to analyse the effect of these blocking devices on individual substations.

Grounding resistance [Ω]	Substation 2 T1 [A]	Substation 2 T2 [A]	Substation 6 T1 [A]	Substation 6 T2 [A]	Substation 8 T1 [A]	Substation 8 T2 [A]
0,2	83,71	83,67	155,11	155,11	58,42	58,42
0,4	69,2	69,15	124,21	124,21	54,71	54,71
0,6	58,97	58,93	103,57	103,57	51,44	51,44
0,8	51,38	51,34	88,82	88,82	48,55	48,55

Table 34 GIC in different transformers when increasing grounding resistance in each substation.

If the grounding resistance were too large, the substation can be severely affected by asymmetric faults. In case of an asymmetric fault and a large grounding resistance, the corresponding protections will not be able to act in order to protect the substation. For this reason a compromise must be found.

If the grounding resistances were to be attached in the other substation, not the ending ones, the effect would be the same; the induced current will be lesser and hence the reactive losses in the transformers next to them will decrease. The global performance will improve as well, since the induced currents due to disturbances are lesser in this case too.

As can be seen in the previous table, in which that only one resistance is changed at a time and that only one transformer is monitored at a time; all transformers of substations reduce their reactive losses when a blocking device is applied in the generator next to them.

That demonstrates that each transformer is better protected when a blocking device is active. The enhancement of the global performance is also remarkable, just a single blocking device can secure the entire system under certain conditions of GMD (direction and magnitude).

## Effect of grounding resistance on GIC distribution

As an improvement to the previous study, the effect of modifying the grounding resistance of a single substation over the rest of the substations will be analysed.

The substations used for this study are substation 2 and substation 3, the grounding resistance will be increased from default level, i.e.  $0.2 \Omega$ , until  $1\Omega$ . It is expected that the induced currents in all the substations will be lower, since the circuit in which they flow is more resistive, the currents will be lower.

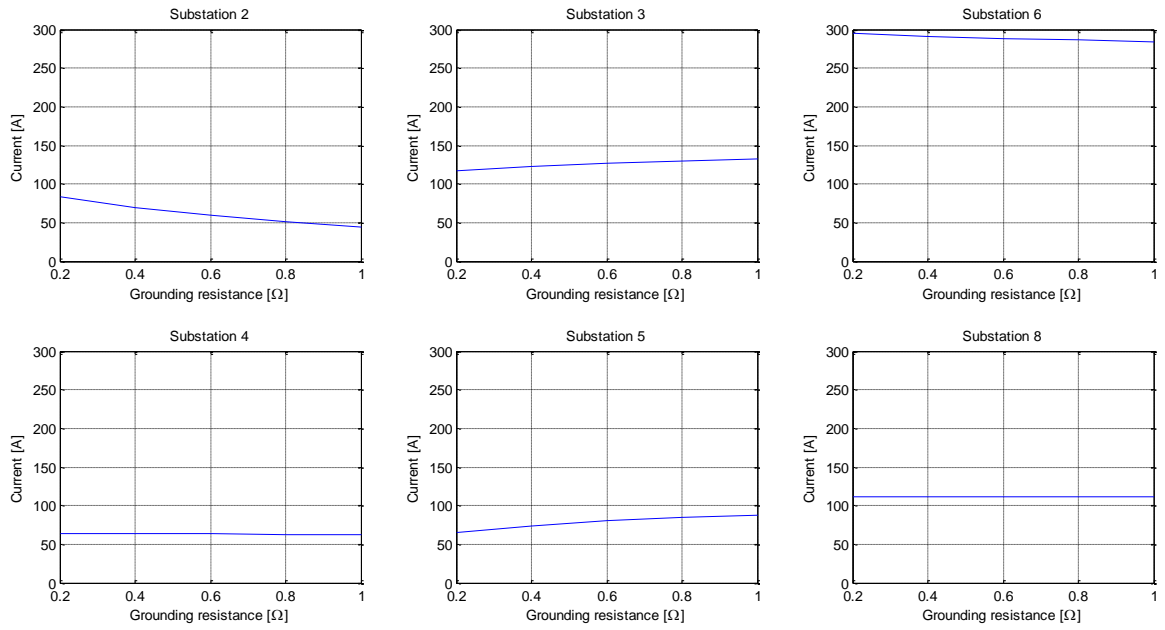

Figure 35 Induced current in different busses when modifying resistance in substation 2, equal scales.

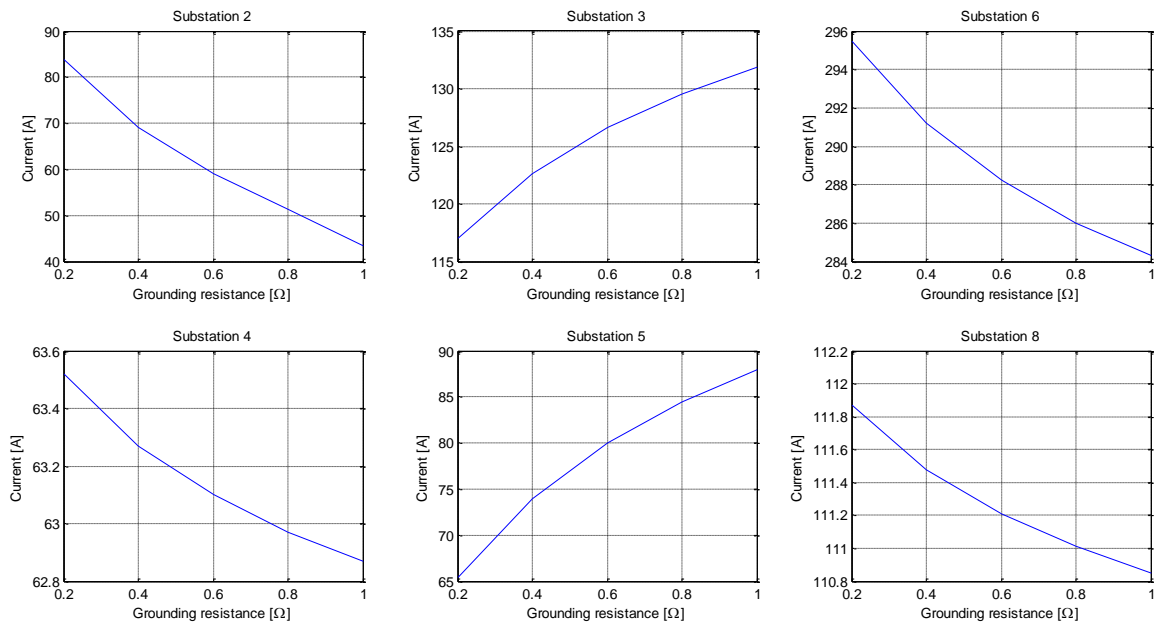

Figure 36 Induced current in different busses when modifying resistance in substation 2, magnified.

In the following picture the absolute results will be overlapped to the general picture, so the reader can have a clearer image of the change.

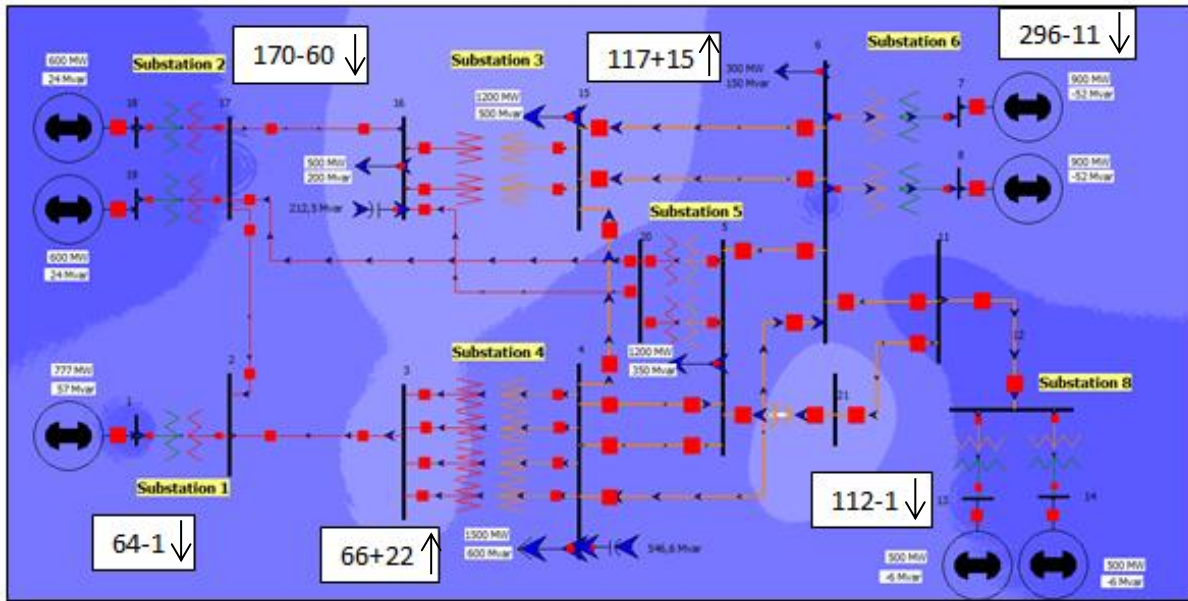

Figure 37 Induced current in different busses when modifying resistance in substation 2 [A]

The study shows us that the different currents have different behaviour depending of the physical position of the substation.

In the case of substations 3 and 5, when grounding resistance in substation 2 increases, the induced current increases but in substations 4,6 and 8 they decrease instead. Substations 4,6 and 8 are endings of circuit, that explains the behaviour of the current, it decreases almost inversely proportional to the increase of grounding resistance. The greater the resistance, the lower the induced current will be.

In the case of substations 3 and 5 happen something not intuitive, the induced currents in both substations increase. Even if they decrease at the endings of the circuit, they seem to increase in the inner substations.

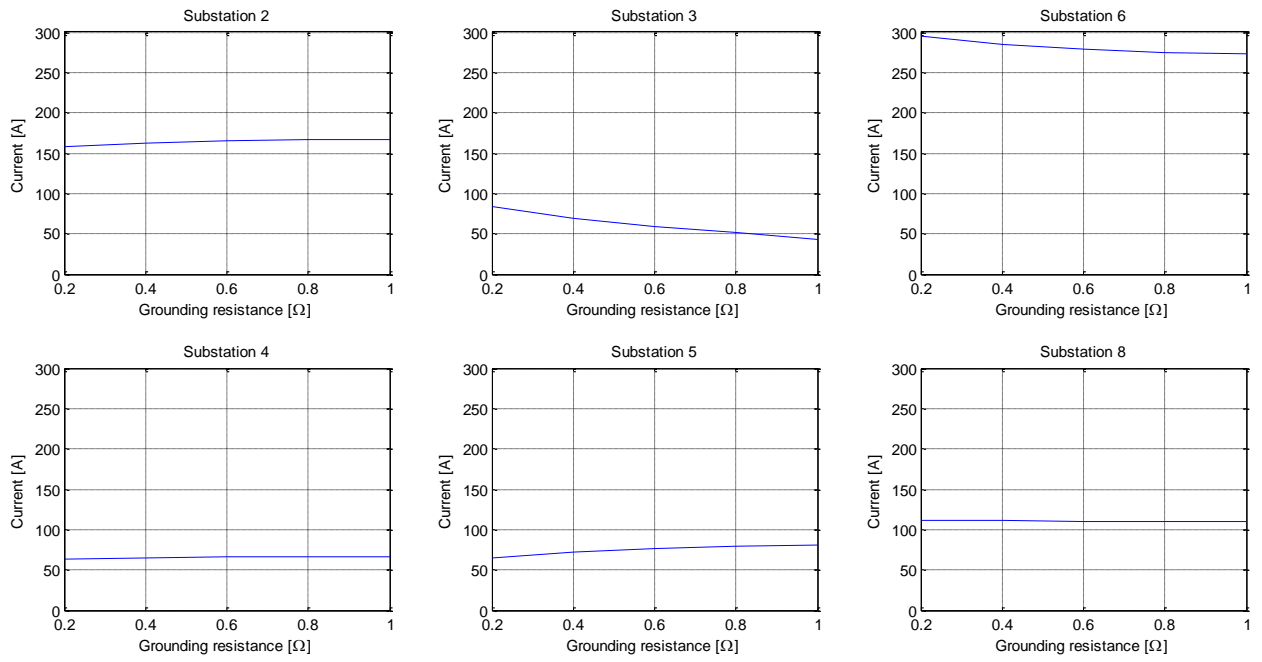

Figure 38 Induced current in different busses when modifying resistance in substation 3, full scale.

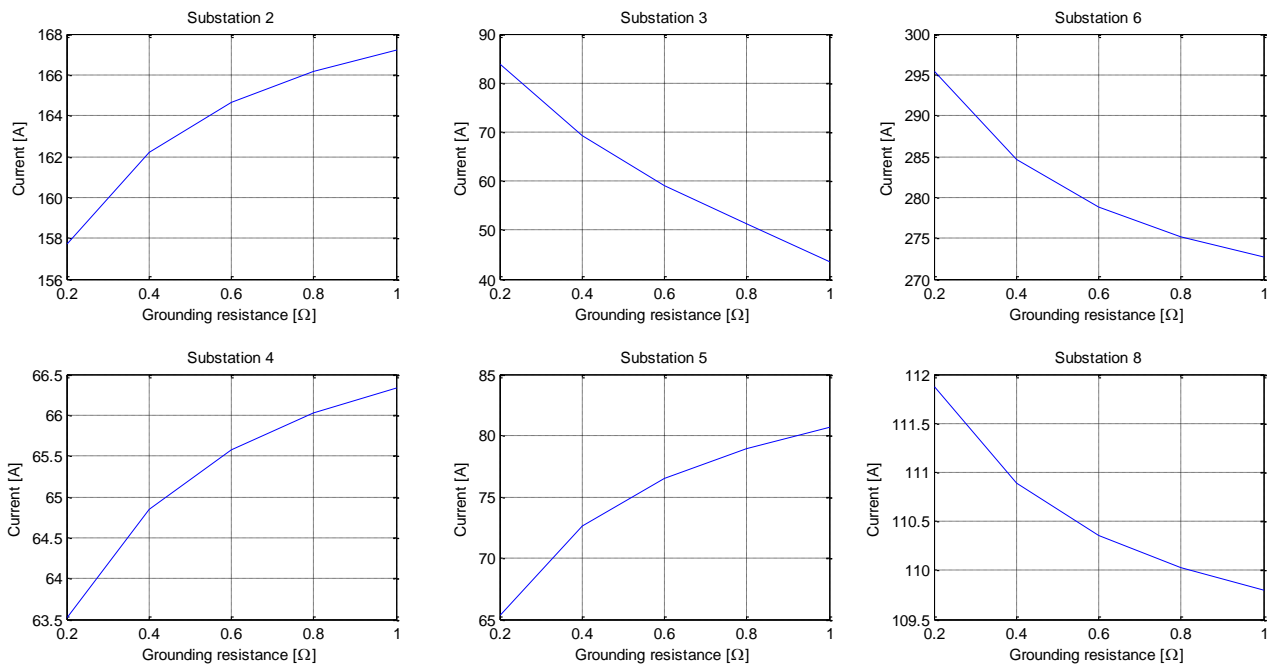

Figure 39 Induced current in different busses when modifying resistance in substation 3

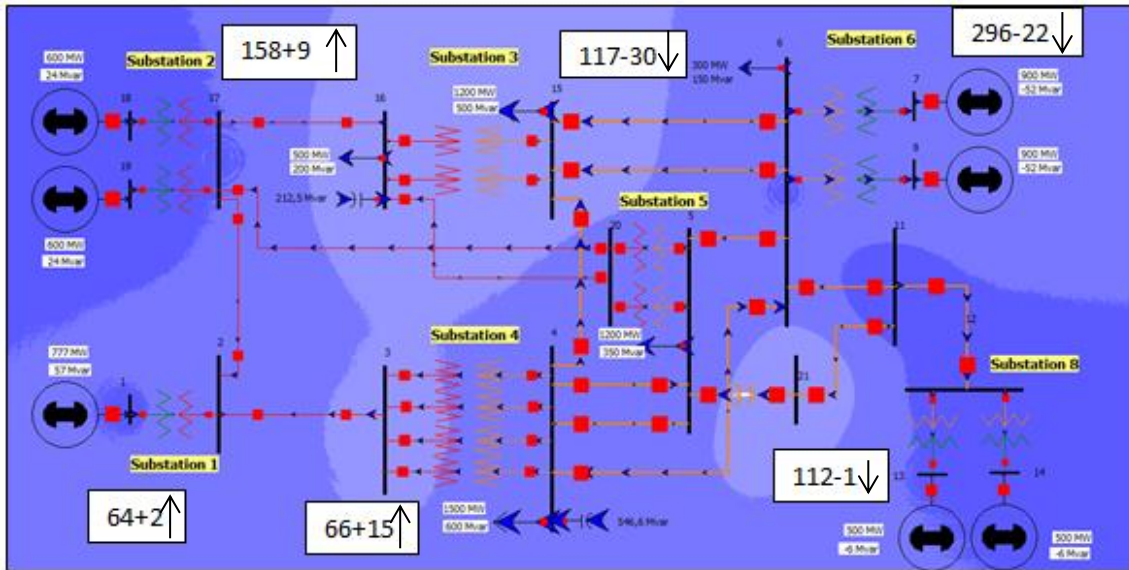

Figure 40 Induced current in different busses when modifying resistance in substation 3 [A]

In the case of modifying the grounding resistance of substation 3, the behaviour of the induced currents can be observed in the graphs above. The analogous procedure has been applied and the results are similar than those in the previous study.

## Effect of switching lines/transformers on GIC

In case of modifying the system, the induced currents will be altered. These currents are induced along the transmission lines, if some lines are disconnected, the corresponding GIC sources are also disconnected and then the currents will not be induced. On the other hand, the transmission capacity of the grid will decrease.

In the case of the transformers being disconnected, the induced currents will be the same, but the reactive losses due to those currents will be lesser. Most of the losses produced by the GIC occur in the transformers, in our system there are various transformers located in parallel.



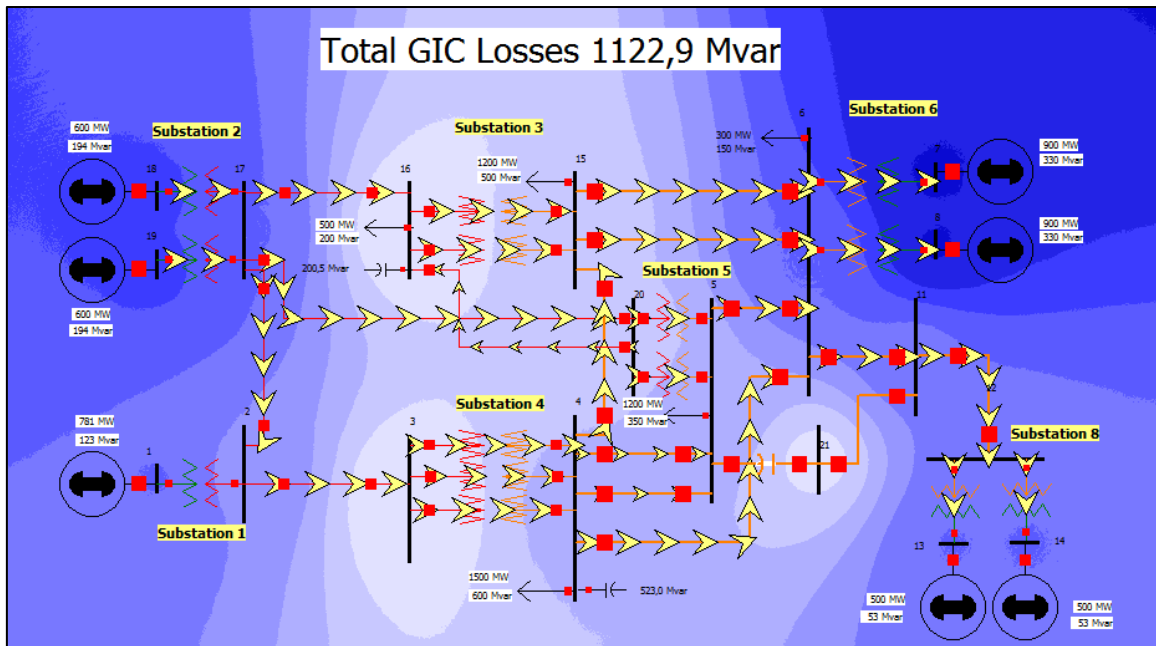

Figure 41 21 Bus system without one of the transformers in parallel.

In Figure 37 it can be observed that in substation 4 one of the transformers has been disconnected.

The total losses of the new system have decreased, from 1124.5 Mvar to 1122.9 Mvar, the drop is not as big as expected because the induced currents are redirected through the remaining transformers.

The losses in the skipped transformer were 63 Mvar while the improvement in performance is just 1.6 Mvar, the rest of the losses are in the other three transformers which have increased their losses.

The DC current that flows through the said substation is the same even if one transformer is disconnected; therefore the system behaviour overall is not altered by the change, the generators will be required to provide less active and reactive power since there is no transformer that consumes them. Same total DC (GIC) in fewer transformers means more in each, which leads to a situation closer to saturation and less margin to blackout. The voltages at the ends of the substation will switch slightly, mostly in value due to the lesser reactive power flowing, the angle will remain at the same level as before.

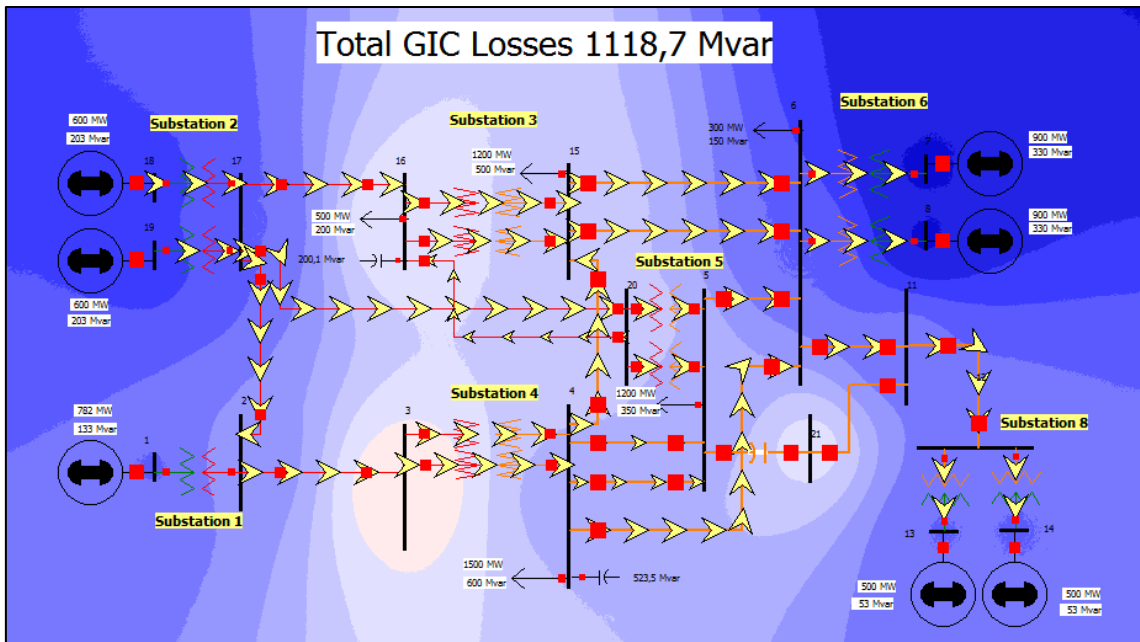

Figure 42 21 Bus system without two of the transformers in parallel.

If the disconnected transformers are two instead of one, the losses are even lower. Again, the losses decrease not as much as expected due to the redirection of the currents in substation 4, from 1122.9 Mvar to 1118.7 Mvar. This is applicable for the whole system; those substations that comprise more than one transformer in parallel can get rid of some of them.

Although the reactive losses decrease when switching lines or transformers, the capacity of the system also decreases, when two transformers are disconnected, the current that can flow through this substation is less than the current that could flow before; this can negatively affect the proper functioning of the grid.

In the following picture all the possible transformers and lines that were in parallel with others have been disconnected, therefore the reactive losses have decreased while the capacity of the lines decreases as well. The system as a whole can be considered equal or equivalent since the voltages, the currents, the loads and the generators remain constant.

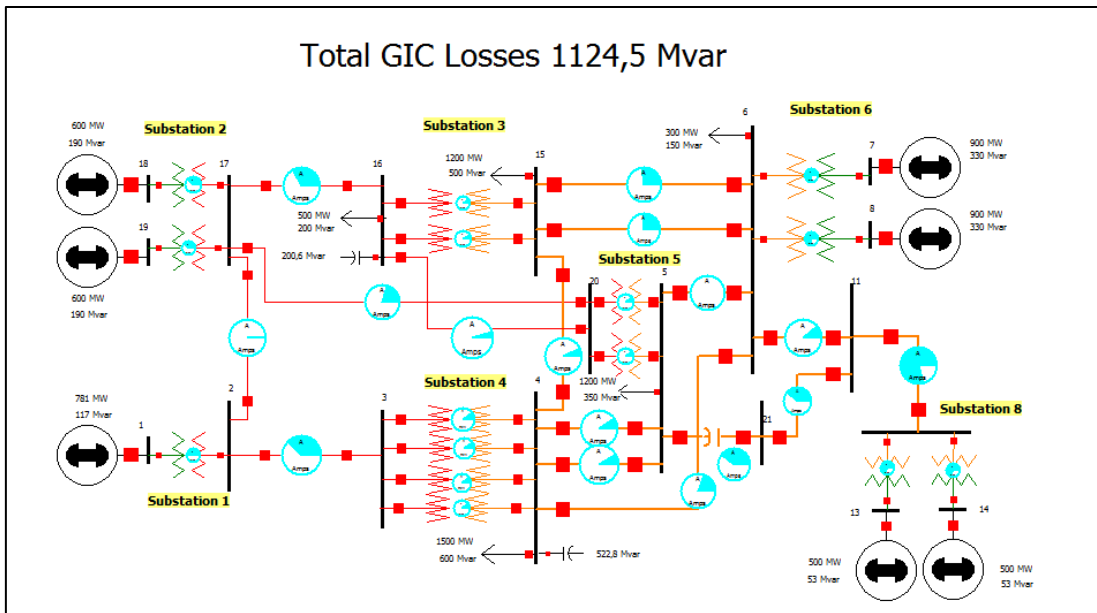

Figure 43 21 Bus system, all transformers and lines.

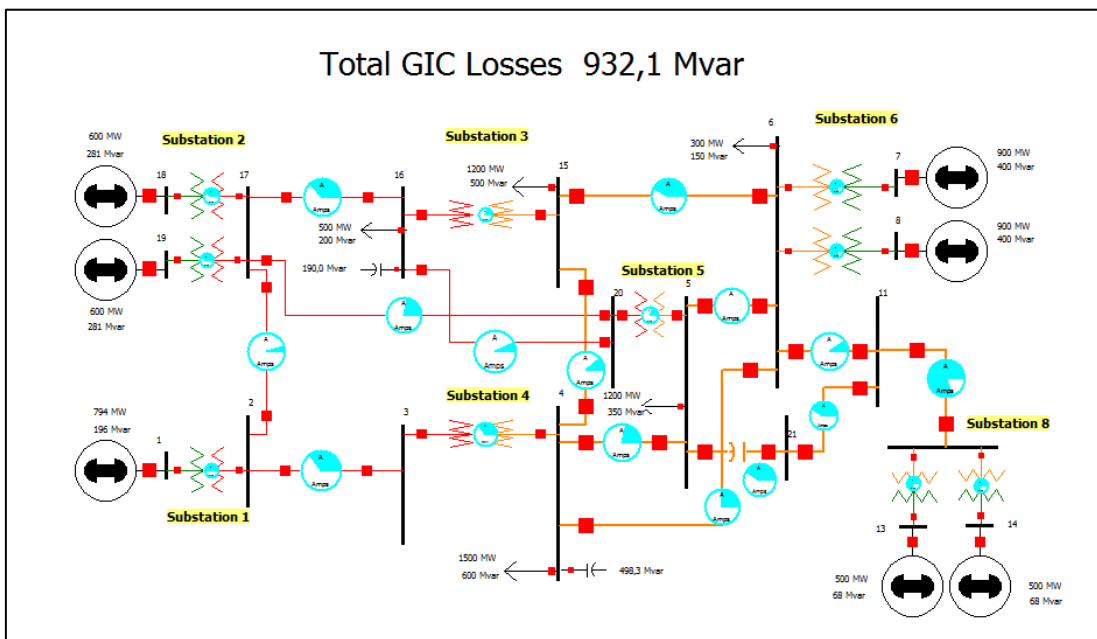

Figure 44 21 Bus system without all the possible skipped elements.

Both situations can be easily compared, in the case of the line between substations 3 and 6, it reaches almost half of its capacity, while in the first case it was about a quarter.

A similar situation is given on the substations 3 and 4, the current that flows through both transformers is increased, but still they do not reach their maximum capacity.

As a conclusion it can be said that disconnecting lines and/or transformers may improve the safety of the system against Geomagnetic disturbances because GIC are not induced (case of disconnecting lines) or the losses are lower (case of transformers). The new system comprised of fewer elements will be able to carry less power and it will not be reliable in case of raise of demand, it will need to be upgraded if so.

Also under greater fields of GMD the system with less elements is less reliable because the voltage can drop easily.

## Chapter 7

# Conclusions

The primary aim of this project was to study the impact of different parameters on GIC distribution and transformer/system performance in case of Geomagnetic Disturbances caused by solar activity and the secondary aim was to learn capabilities of the PowerWorld simulator.

The four bus system provides useful information about how geomagnetic disturbances become induced currents in the system. Two distinctive flows must be differentiated, one being the AC flow supplied by the generators to the loads in the system, the other one being the direct current flow induced by the GMD events that may occur in the atmosphere.

Studying the four bus system, also called one-dimensional system, the trends of the currents under different conditions can be predicted. In this first case no alternating current was to run along the single line, only direct current due to GIC is noticed. This current can be diminished or totally prevented by using various devices or changing the configuration of the transformers.

The core type of the transformer decides how it is affected by GIC. The transformer losses (as affected by GIC) have large influence on system Mvar losses. This does not improve the performance of the entire system, but secures the transformer itself.

As capacitors are not a convenient solution and modifying the core of the transformers secures mainly the transformer itself, the focus will be on setting the grounding resistance of different busses and its effects on the entire system.

Capacitors act as interruptions for direct current, therefore it blocks induced current where they are placed, a priori a real solution; however this solution is not optimal because it constrains the safety of the system under the effects of asymmetrical faults. Current goes through neutral only at asymmetrical conditions.

Following the study to a greater system, such as the 21 bus system, more realistic results and conclusions can be achieved.

Capacitors installed in transformers do not allow the DC currents to go through that line, but they are useful to lower the AC voltage in the busses in order to maintain the voltage below its limits.

Increasing the grounding resistance the induced currents are diminished; however a non-expected response on the other busses was reached. AC wise the system remains constant but in the case of direct current, GIC can increase in other substations when increasing grounding resistance of a transformer. This happens because of the flow in different current loops, it must increase in certain nodes in order to compensate the lack of current in others, according to the law of Kirchhoff.

Overall this is the best solution, is, as it ensures both the good functioning of the system and individual transformers when used in all substations of the system and it does not constrain the security in case of asymmetrical faults.

Finland combines best transformer core with resistive earthing (actually in reactors). A comparison of typical transformer/earthing solutions in Sweden, Finland and USA revealed that out of these three Finland was best.

As further development of this research, a more realistic system can be modelled. Taking as example one country such as Sweden that works with geomagnetic induced currents, a model can be done in order to secure a certain system, in this case an entire country.

# Chapter 8

## References

- [1] Overbye, T. J., Hutchins, T. R., Shetye, K., Weber, J., & Dahman, S. (2012, September). Integration of geomagnetic disturbance modeling into the power flow: A methodology for large-scale system studies. In North American Power Symposium (NAPS), 2012 (pp. 1-7). IEEE.
- [2] Samuelsson, O. (2013), geomagnetic disturbances and their impact on power systems - Status report 2013. Technical report, Division of Industrial Electrical Engineering and Automation, Lund University, LUTEDX/(TEIE-7242)/1-21/(2013)
- [3] IEEE Power and Energy Society Technical Council Task Force on Geomagnetic Disturbances, "Geomagnetic Disturbances," IEEE Power & Energy Magazine, July/August 2013, pp 71-78.
- [4] Hudson, H. S., & Cliver, E. W. (2001). Observing coronal mass ejections without coronagraphs. *Journal of Geophysical Research: Space Physics* (1978–2012), 106(A11), 25199-25213.
- [5] Wikipedia. March 1989 Solar Storm. [http://en.wikipedia.org/wiki/Solar\\_storm\\_of\\_1859](http://en.wikipedia.org/wiki/Solar_storm_of_1859). (March 2014).
- [6] Thornberg, R. (2012). Risk analysis of geomagnetically induced currents in power systems. MSc thesis, Industrial Electrical Engineering and Automation, Faculty of Engineering, LTH, Lund University.
- [7] Hutchins, T. (2012). Geomagnetically induced currents and their effect on power systems (Doctoral dissertation, University of Illinois).
- [8] Overbye, T. J., Shetye, K. S., Hutchins, T. R., Qiu, Q., & Weber, J. D. (2013). Power Grid Sensitivity Analysis of Geomagnetically Induced Currents, IEEE Transactions on Power Systems, Vol 28, Issue 4, pp 4821-4828.
- [9] Viljanen, A., & Pirjola, R. (1994). Geomagnetically induced currents in the Finnish high-voltage power system. *Surveys in Geophysics*, 15(4), 383-408.

- [10] D. Laoux. (2013). Fundamentos de Tecnología eléctrica- Transformadores Trifásicos, UPCO-Madrid, <http://www.iit.upcomillas.es/~dlaloux/fte/docs/TrafosTrif.pdf> (12 June 2014)
- [11] Eurisgic.eu .- Risk map. <http://www.eurisgic.eu/index.php/risk-map>. (March 2014).
- [12] S. Mousavi, G. Engdahl, E. Agheb. Investigation of GIC effects on core losses in single phase power transformers. Archives of Electrical Engineering. Volume 60, Issue 1, Pages 35–47, March 2011.
- [13] Heindl, M., Beltle, M., Reuter, M., Schneider, D., Tenbohlen, S., Oyedokun, D. T., & Gaunt, C. T. (2011). Investigation of GIC Related Effects on Power Transformers Using Modern Diagnostic Methods. In XVII International Symposium on High Voltage Engineering, Hannover, Germany.
- [14] J. Kappenman.- Low-Frequency Protection Concepts for the Electric Power Grid: Geomagnetically Induced Current (GIC) and E3 HEMP Mitigation, Metatech Corporation, Meta-R-322, January 2010.
- [15] Berge, J. J. E. (2011). Impact of Geomagnetically Induced Currents on Power Transformers (Doctoral dissertation, The University of Western Ontario).
- [16] PowerWorld. GIC Modeling. Modeling Geomagnetically induced Currents in PowerWorld Simulator. March 22, 2012.
- [17] Zheng, K., Boteler, D. H., Pirjola, R. J., Liu, L. G., Becker, R., Marti, Guillon, S. Effects of System Characteristics on Geomagnetically Induced Currents, IEEE Transactions on Power Delivery, Vol 29, Issue 2, pp 890-898, (2013).
- [18] Koen, J., & Gaunt, C. T. (2002). Geomagnetically induced currents at mid-latitudes. Proceedings of the 27th General Assembly of URSI, Maastricht, Netherlands.
- [19] Pulkkinen, A., Bernabeu, E., Eichner, J., Beggan, C., & Thomson, A. W. P. (2012). Generation of 100 year geomagnetically induced current scenarios. Space Weather, 10(4).
- [20] N. Chiesa, A. Lotfi, H. K. Høidalen, B. Mork, Ø. Rui, T. Ohnstad Five-leg transformer model for GIC studies. International conference on power system transients (IPST 2013), Vancouver, Canada, 18-20 July, (2013).



## Chapter 9

### Appendix 1.

# Where to find GIC commands in PowerWorld

This appendix is done to help the reader using PowerWorld.

First of all, the GIC add on can be found in the upper menu, in which direction and magnitude of the geomagnetic field can be modified. The option selected and the resulting pop-up window can both be seen in the picture below. The black arrow indicates where to press to obtain such result.

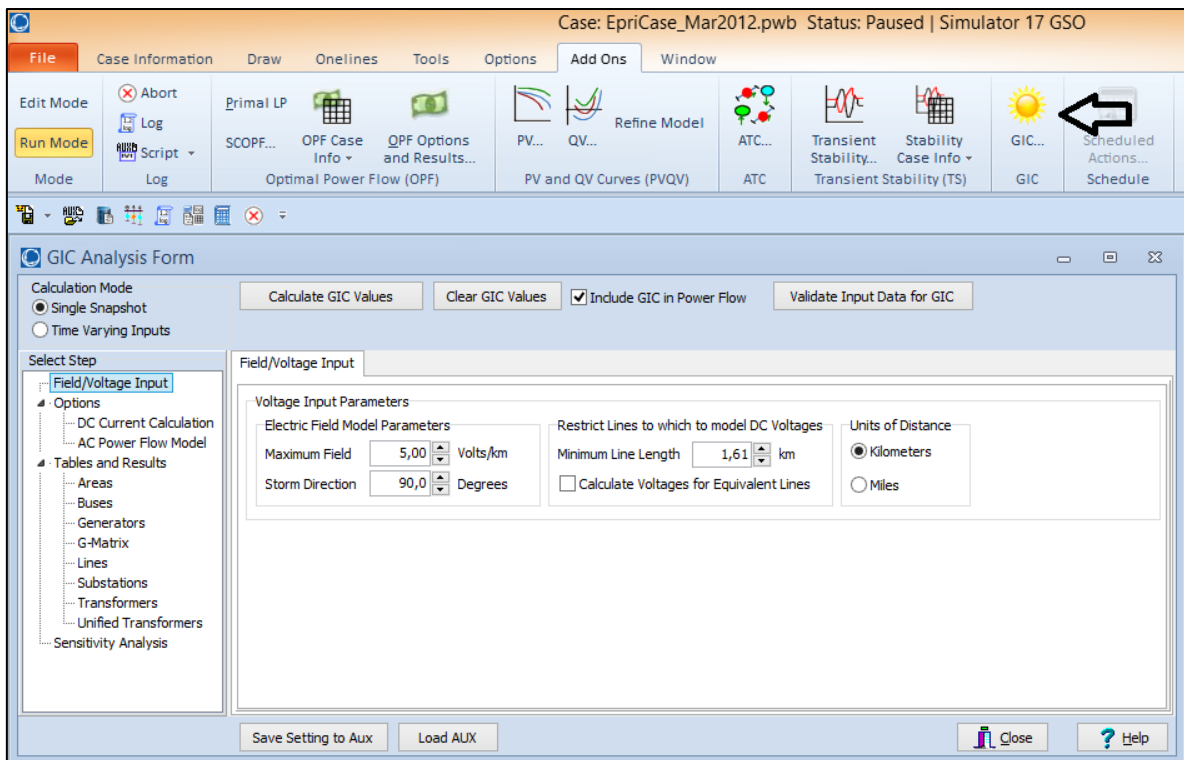

Figure 45 PowerWorld window GIC Analysis Form

The next option that requires explanation will be the grounding resistance of the different substations, it can be done in few steps. It is needed to deploy the substation view first. The picture below shows how to do it:

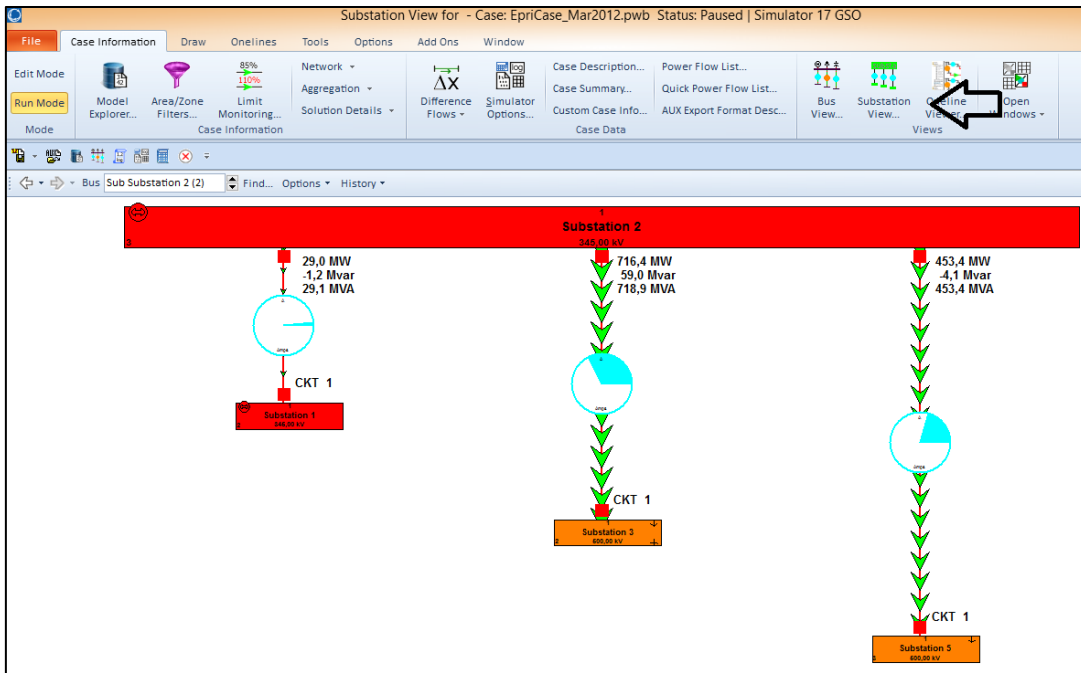

Figure 46 Powerworld Substation view

Once the substation view is open, substation option can be selected. After clicking the chosen substation bar, a new pop-up will be displayed, containing all the information and possible modifiable parameters, shown in the picture below:

Load and Generation		MW	Mvar
Load		0,0	0,0
Generation		1200,0	272,1
Shunts		0,0	0,0
Losses		19,69	323,00
Interchange		1180,3	-50,9

Bus Voltages	
Number of Buses	3
Number of Dead Buses	0
Max Voltage Level (kV)	345,00
Min Voltage Level (kV)	22,00
Max Voltage (p.u.)	1,0567
Min Voltage (p.u.)	1,0500
Max Angle (deg)	-3,36
Min Angle (deg)	-7,38

Available Gen MW/Mvar Ranges	
Max. Gen AGC Increase (MW)	0,0
Max. Gen AGC Decrease (MW)	0,0
Available Gen Mvar (Increase)	527,9
Available Gen Mvar (Decrease)	872,1

Figure 47 PowerWorld substation information

Clicking the GIC tab, a new menu will be displayed and the grounding resistance of the substations could be chosen.