



**COMILLAS**

UNIVERSIDAD PONTIFICIA

ICAI

# GRADO EN INGENIERÍA EN TECNOLOGÍAS INDUSTRIALES

TRABAJO FIN DE GRADO  
ZIPPER CLIMBER

Autor: Ana Serrano Riera

Director: Bruce Flachsbart

Madrid

Julio de 2019



# **AUTHORIZATION FOR DIGITALIZATION, STORAGE AND DISSEMINATION IN THE NETWORK OF END-OF-DEGREE PROJECTS, MASTER PROJECTS, DISSERTATIONS OR BACHILLERATO REPORTS**

## ***1. Declaration of authorship and accreditation thereof.***

The author Mr. /Ms. \_\_\_\_\_

**HEREBY DECLARES** that he/she owns the intellectual property rights regarding the piece of work:

that this is an original piece of work, and that he/she holds the status of author, in the sense granted by the Intellectual Property Law.

## ***2. Subject matter and purpose of this assignment.***

With the aim of disseminating the aforementioned piece of work as widely as possible using the University's Institutional Repository the author hereby **GRANTS** Comillas Pontifical University, on a royalty-free and non-exclusive basis, for the maximum legal term and with universal scope, the digitization, archiving, reproduction, distribution and public communication rights, including the right to make it electronically available, as described in the Intellectual Property Law. Transformation rights are assigned solely for the purposes described in a) of the following section.

## ***3. Transfer and access terms***

Without prejudice to the ownership of the work, which remains with its author, the transfer of rights covered by this license enables:

- a) Transform it in order to adapt it to any technology suitable for sharing it online, as well as including metadata to register the piece of work and include "watermarks" or any other security or protection system.
- b) Reproduce it in any digital medium in order to be included on an electronic database, including the right to reproduce and store the work on servers for the purposes of guaranteeing its security, maintaining it and preserving its format.
- c) Communicate it, by default, by means of an institutional open archive, which has open and cost-free online access.
- d) Any other way of access (restricted, embargoed, closed) shall be explicitly requested and requires that good cause be demonstrated.
- e) Assign these pieces of work a Creative Commons license by default.
- f) Assign these pieces of work a HANDLE (*persistent* URL). by default.

## ***4. Copyright.***

The author, as the owner of a piece of work, has the right to:

- a) Have his/her name clearly identified by the University as the author
- b) Communicate and publish the work in the version assigned and in other subsequent versions using any medium.
- c) Request that the work be withdrawn from the repository for just cause.
- d) Receive reliable communication of any claims third parties may make in relation to the work and, in particular, any claims relating to its intellectual property rights.

## ***5. Duties of the author.***

The author agrees to:

- a) Guarantee that the commitment undertaken by means of this official document does not infringe any third party rights, regardless of whether they relate to industrial or intellectual property or any other type.

- b) Guarantee that the content of the work does not infringe any third party honor, privacy or image rights.
- c) Take responsibility for all claims and liability, including compensation for any damages, which may be brought against the University by third parties who believe that their rights and interests have been infringed by the assignment.
- d) Take responsibility in the event that the institutions are found guilty of a rights infringement regarding the work subject to assignment.

**6. Institutional Repository purposes and functioning.**

The work shall be made available to the users so that they may use it in a fair and respectful way with regards to the copyright, according to the allowances given in the relevant legislation, and for study or research purposes, or any other legal use. With this aim in mind, the University undertakes the following duties and reserves the following powers:

- a) The University shall inform the archive users of the permitted uses; however, it shall not guarantee or take any responsibility for any other subsequent ways the work may be used by users, which are non-compliant with the legislation in force. Any subsequent use, beyond private copying, shall require the source to be cited and authorship to be recognized, as well as the guarantee not to use it to gain commercial profit or carry out any derivative works.
- b) The University shall not review the content of the works, which shall at all times fall under the exclusive responsibility of the author and it shall not be obligated to take part in lawsuits on behalf of the author in the event of any infringement of intellectual property rights deriving from storing and archiving the works. The author hereby waives any claim against the University due to any way the users may use the works that is not in keeping with the legislation in force.
- c) The University shall adopt the necessary measures to safeguard the work in the future.
- d) The University reserves the right to withdraw the work, after notifying the author, in sufficiently justified cases, or in the event of third party claims.

Madrid, on ..... of ....., .....

**HEREBY ACCEPTS**

Signed.  .....

Reasons for requesting the restricted, closed or embargoed access to the work in the Institution's Repository

I, hereby, declare that I am the only author of the project report with title:

ZIPPER CLIMBER – a Mechanically Automated Zipper

which has been submitted to ICAI School of Engineering of Comillas Pontifical University in the academic year 2018/19. This project is original, has not been submitted before for any other purpose and has not been copied from any other source either fully or partially. All information sources used have been rightly acknowledged.



Fdo.: Ana Serrano Riera

Date: 21/06/2019

I authorize the submission of this project

PROJECT SUPERVISOR



Fdo.: Prof. Bruce Flachsbart

Date: 21/06/2019





**COMILLAS**

UNIVERSIDAD PONTIFICIA

ICAI

# GRADO EN INGENIERÍA EN TECNOLOGÍAS INDUSTRIALES

TRABAJO FIN DE GRADO  
ZIPPER CLIMBER

Autor: Ana Serrano Riera

Director: Bruce Flachsbart

Madrid

Julio de 2019





# AYUDANTE DE CREMALLERA

**Autor: Serrano Riera, Ana.**

Director: Flachsbart, Bruce.

Entidad Colaboradora: ICAI – Universidad Pontificia Comillas

## **RESUMEN DEL PROYECTO**

### **Introducción**

Al momento de pensar qué proyecto realizar, un aspecto estaba claro: tenía que ser un proyecto innovador que ayudaría a las personas en su día a día. Después de investigar y pensar en diferentes posibilidades, el proyecto consistió en la creación de un producto (“Ayudante de cremallera”) que podría estar disponible en el mercado para ayudar a la gente a subir y bajar las cremalleras de la ropa en lugares donde es difícil llegar. Pero esta función no fue la única, sino que este producto también podía ser útil para aquellas personas con discapacidad o movilidad reducida.

Para el desarrollo del proyecto, una investigación de los antecedentes era necesaria para conocer lo que ya existía y las necesidades del mercado. Solo se encontró un producto similar que podría ayudar a la gente a subir y bajar la cremallera, pero no ayudaba a las personas con discapacidad. Este producto era una especie de gancho, unido a una cuerda. Este producto era bastante simple mecánicamente hablando, no constaba de partes mecánicas, por lo que el diseño era bastante diferente comparado con el de este proyecto. Aunque puede solucionar un problema similar, no es innovativo, y se podría romper con facilidad. En cambio, este proyecto es innovativo porque la manera en la que se busca solucionarlo no existe, y tiene conceptos de la ingeniería que lo hacen atractivo. El mecanismo de cuerda es un aspecto desafiante que necesitaba ser solucionado para hacer que el producto funcionara. Además, también se tuvo que hacer un estudio para encontrar maneras para conseguir que el producto se moviera más lejos, y se consiguió.

### **Metodología**

Una vez que la idea del proyecto estaba determinada, un proceso iterativo se llevó a cabo para encontrar la mejor solución al problema. Gracias a este proceso iterativo, fue fácil determinar qué características de cada prototipo funcionaban correctamente y debían

ser implementadas en el siguiente, y cuáles no. Esta metodología es muy útil para el diseño de cualquier producto. Al principio es difícil conseguir tener un buen prototipo, pero conociendo las ventajas y desventajas de cada uno ha demostrado ser un proceso eficiente.

También, para el desarrollo del este proyecto, un estudio de las diferentes técnicas se ha hecho para encontrar las mejores técnicas disponibles para el diseño del producto. Dichas técnicas fueron: Impresión en 3D (Estereolitografía, Sinterizado Selectivo de Láser y Modelado por Deposición Fundida), Mecanización, Inyección y Corte con Láser. Después de la investigación de las diferentes técnicas, se encontraron las mejores técnicas para el desarrollo del proyecto: Modelado por Deposición Fundida y Corte con Láser. La mayor parte de las piezas eran impresas usando las impresoras disponibles en el laboratorio, sin embargo, para aquellas partes que requerían tener mucha precisión o que eran muy pequeñas, por lo que quitar el material de apoyo era muy difícil, se usó corte con láser.

Diferentes recursos se han necesitado para la realización del proyecto:

- Programa Creo Parametric, para el diseño de la mayor parte de las piezas usadas en el proceso iterativo.
- Aprioir, para predecir el coste de fabricación de cada pieza.
- Excel.
- Pegamento para madera.
- Madera.
- Cartón.

También se usaron dos métodos para mejorar algunos aspectos que resultaron ser muy útiles, ya que se usaron en la última etapa del proceso para mejorar el prototipo final y ver qué características o piezas deberían ser sustituidas para obtener la máxima eficiencia del producto. Estos dos métodos fueron: diseño para la experimentación y optimización y diseño para el montaje.

Diseño para la experimentación y optimización es un método usado para mejorar el diseño del producto. Gracias a este método, fue posible conocer qué piezas eran las óptimas para usar mediante operaciones matemáticas y estadísticas.

Diseño para el montaje es un método que se usa una vez que el producto está creado y funciona correctamente. Se usa para optimizar el tiempo empleado en el montaje del producto. Con este método, también se pudo eliminar piezas que no eran necesarias y que incrementaban el tiempo y la complejidad del montaje.

Inicialmente, la idea era hacer un producto que se pareciera a una araña de juguete. Las patas de la araña serían las que “escalaran” la cremallera. Al principio, en la ideación, se pensó que el movimiento sería creado por motores, sin embargo, esta idea era muy simple y nada desafiante, por lo que, en lugar de esto, se usó un sistema de cuerda que guarda la energía. Una vez enseñada la técnica de impresión en 3D, se pudo comprobar que diseñar piezas del tamaño de una cremallera real sería un trabajo demasiado complejo. Por lo tanto, una nueva aproximación era necesaria para solucionar el problema. Esta nueva aproximación, consistía en poder subir la cremallera sin la ayuda del tirador. De esta manera, se podría diseñar una cremallera del tamaño deseado e imprimirla en el laboratorio, y a partir de esta, crear un producto de acuerdo a sus dimensiones. Una rueda con “brazos” serían las que empujarían las piezas pequeñas de la cremallera y las engancharían. Estas ruedas rotarían porque estarían unidas a una cadena, unida a su vez a los engranajes principales donde estaría situado el sistema de cuerda.

Como el uso de ruedas con “brazos” sería muy difícil para conseguir empujar las piezas de la cremallera, se hizo un nuevo diseño de cremallera para usar ruedas sin “brazos”. Además, esta cremallera, se parece más a una cremallera real. En esta nueva aproximación, una estructura de soporte se ha usado, pero después de algunas pruebas, resultó no ser estable. Además, la idea de conectar los engranajes principales a las ruedas era muy complejo, por lo que se cambió de idea.

En la siguiente iteración, en lugar de conectar las ruedas y los engranajes con una cadena, se ha usado un conjunto de engranajes para unir ambos. Dos de estos engranajes estarán en el mismo eje que las ruedas, por lo que, si los engranajes rotan, las ruedas rotarán también. Esta nueva idea parecía que iba a funcionar bien al principio, pero los engranajes que se imprimieron no eran precisos y había mucha fricción entre las ruedas y el suelo, lo que dificultaba el movimiento.

Después de mucha investigación, la mejor idea para solucionar el problema fue crear un producto que se pareciera a un coche de juguete. Este producto tendría unas ruedas unidas, que serían las que empujaran las piezas de la cremallera. Es en este

prototipo donde los dos métodos de mejora se hicieron (Diseño para la experimentación y optimización y Diseño para el montaje).

Las siguientes figuras muestran un resumen de todos los prototipos realizados hasta llegar al prototipo final, y también la cremallera final usada:



Figure 1, Cremallera Final

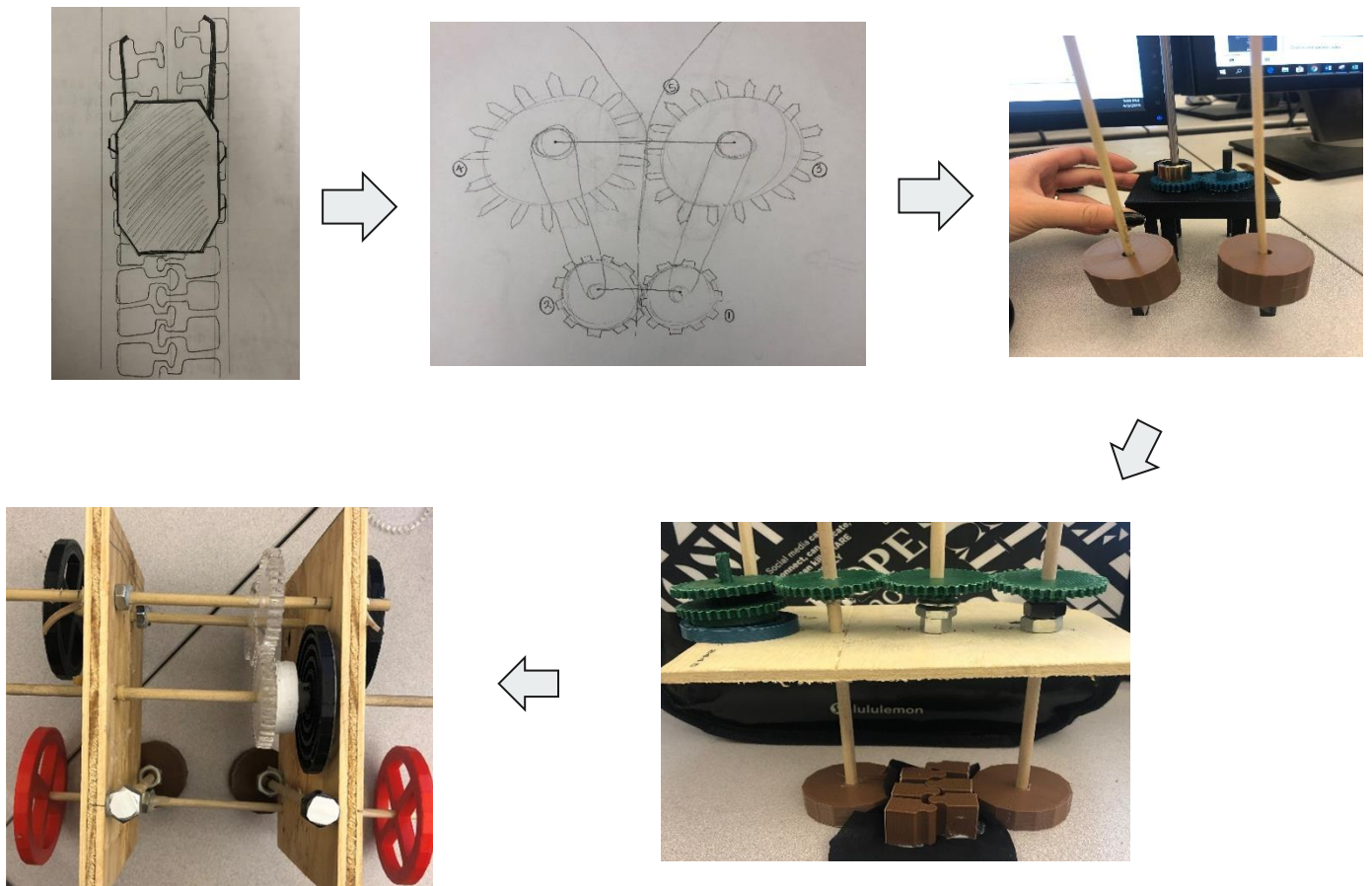

Figure 2, Iteraciones del Proyecto

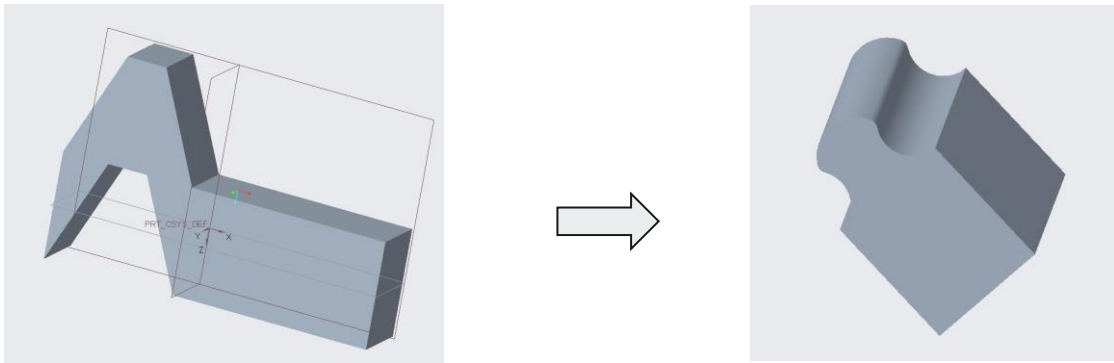

Figure 3, Iteraciones de la Cremallera

## Resultados

Después del proceso de iteración, del Diseño para la experimentación y optimización y del Diseño para el montaje, se creó el prototipo final teniendo en cuenta todas las consideraciones aprendidas. Una de las principales cosas que se cambiaron fue la precisión de los engranajes. Esto se solucionó mediante la técnica de corte de láser. También, gracias al Diseño para la experimentación y optimización, la pieza que guarda la energía se diseñó con unas características determinadas para maximizar el desplazamiento del producto. La estética en este caso jugaba un parte importante, ya que se trataba del ultimo prototipo (un producto que está disponible en el mercado, a parte de tener que ser útil, tiene que ser atractivo). Por esta razón, para la estructura de soporte se utilizó el método de corte de láser, en lugar de madera.

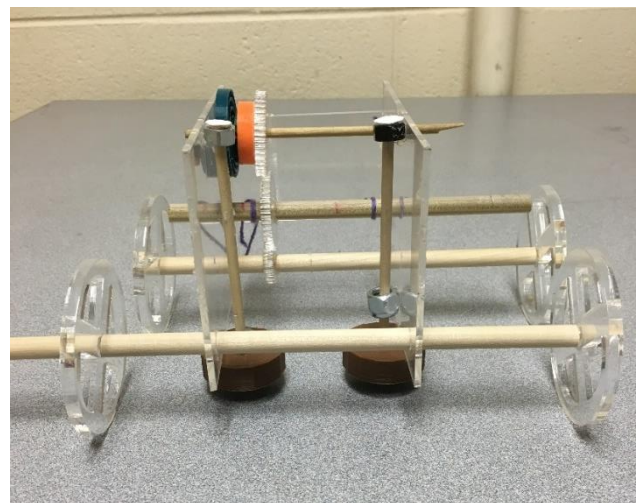



Figure 4, Prototipo Final

### **Conclusión**

Uno de los aspectos mas importantes aprendidos durante el proceso de este proyecto ha sido que los ensayos de prueba y error son los más eficientes para hacer proyectos de este tipo. Aunque algunas características necesitan ser trabajadas en el futuro (el producto era demasiado grande para ser implementado en una cremallera real), las principales (relacionadas con la ingeniería) se han conseguido. También se ha conseguido desarrollar un producto innovador, ya que, problemas comunes pueden tener soluciones creativas.

# ZIPPER CLIMBER

## **Introduction**

When thinking about which project to do, one thing was clear: it had to be an innovative project that would help people in their daily lives. After doing a research and thinking about different possibilities, the project chosen was a product (“Zipper climber”) that could be available in the market to help people do / undo zippers in hard to reach places. Not only this device will help those people, but also those with disabilities or reduced mobility.

For the developing of this project, a background research was needed to know what already existed and the market needs. Only a similar product was found in the market that could help people to do / undo their zippers in hard to reach places, but it would not help those with disabilities. That product was a loop, attached to a string. This product was quite simple in a mechanical aspect, it did not have mechanical parts, so it has a very different design, compared with the present product. Although it can solve the problem similarly, it is not innovative, and could break easily. This project is innovative because the way of solving the problem does not exist, and it has engineering concepts used that make it more attractive. The clockwork system was a challenging aspect that needed to be accomplished in order to make the device work. Also, doing a research to find ways that could help the machine go further was difficult, but accomplished as well.

## **Methodology**

Once the project idea was determined, an iterative process was made to reach the best solution for the project. Thanks to this iterative process, it was easy to determine which characteristics worked and needed to be implemented in the following prototype and which should be replaced by another idea. This methodology is very useful for the design of any product. At the beginning it is very hard to reach some useful prototype but learning the advantages and disadvantages has demonstrated to be a very useful method to accomplish this kind of projects.

Also, for the development of the project, a study of different techniques has been made to find the advantages and disadvantages of the different processes available to design the product. These processes were: 3D Printing (Stereolithography Apparatus, Selective Laser Sintering, Fused Deposition Modelling), Machining, Injection Molding and Laser Cutting. After some research in the laboratory, the best techniques were found that accomplished the aspects to fulfill the needs of the project. These techniques were Fused Deposition Modelling (a type of 3D Printing) and Laser Cutting. Most of the parts were 3D printed using printers available in the laboratory, however, for parts that required accuracy or small parts (where support material would be very hard to remove) laser cutting was the best procedure.

Different resources were needed for the performance of the project

- Creo Parametric program, for the design of most of the pieces used in the iterative process.
- Apriori, to predict the manufacturing cost of each piece.
- Excel.
- Wood glue.
- Wood.
- Cardboard.

Also, two methodologies were used to improve some aspects of the prototypes which resulted to be very useful, because they were used in the final stage of the process to improve the final prototype and see which aspects or pieces should be replaced to obtain the maximum efficiency of the project. These two methodologies were: Design of experimentation and optimization and Design for assembly.

Design of experimentation and optimization (DOE) was a method used to improve the design of the product. Thanks to this method, it was possible to know which pieces were optimal to use, using mathematical and statistical operations.

Design for assembly (DFA), was a method used once the product was created and worked properly. It is used to optimize the time for assembling the product. With this method, deleting some pieces that were not necessary for the correct functioning of the product was also accomplished.



Initially, the idea was to make a product that resembled a spider toy. The legs of the spider would be the ones to climb the zipper up. At the beginning of the ideation, the motion was thought to be originated by motors, however, it was very simple and not challenging, so a clockwork system would be what caused the motion. After being taught the 3D Printing technique, it could be seen that designing a product of the size of a real zipper would be very complex, so a different approach was needed. The next approach consisted in zipping the zipper up, without the help of the tab to design a zipper of any size and design the product according to this zipper. In this idea, some kind of wheels with “arms” would be used to push the pieces of the zipper together. These wheels would rotate because they would be attached by a chain to the main gears where the clockwork system would be stored.

After realising that the use of wheels with arms would be too hard to make the pieces of the zipper be pushed together, a new design of the zipper was needed to be designed in order to use other wheels that would not need those arms. This new zipper would look like more like a real zipper. In this new approach, a support structure was designed, but after some trials, it was not stable enough so it would not work properly. Also, the idea of connecting the main gears to the wheels that would push the zipper pieces together was very complex, so a different approach was needed.

In the next iteration, instead of connecting the wheels and the gears with a chain, a set of gears would be rotating. Two of those gears would be in the same axis as the wheels so when the gears rotate, the wheels would rotate as well. This idea seemed to be working at the beginning, but the gears printed were not accurate and there was too much friction between the wheels and the ground, so the motion was hard.

After some researching, the best idea to solve this problem was to create a product that resembled a car toy. This device would have attached some wheels inside of it that would help to push the zipper pieces together. In this prototype, both methods were made. (Design of experimentation and optimization and design for assembly).

The following figures show a summary of all the prototypes gone through the project until reaching the final one, as well as the final zipper used:



Figure 5, Final Zipper

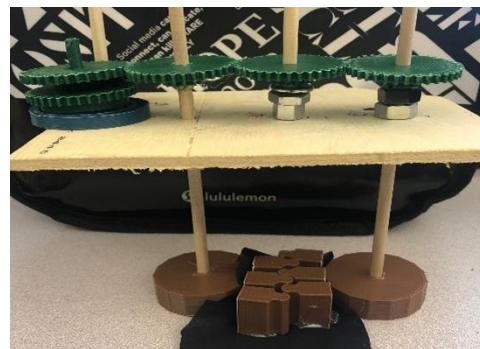
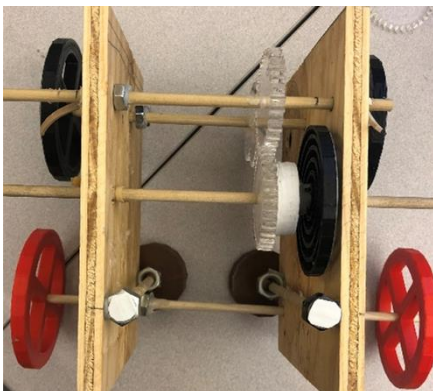
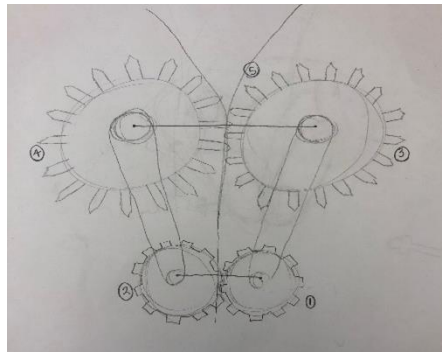
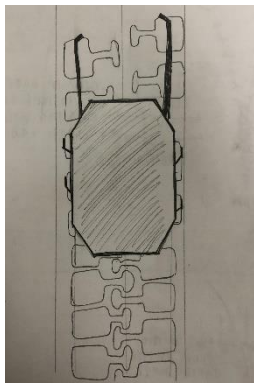

Figure 6, Iterations of the Project

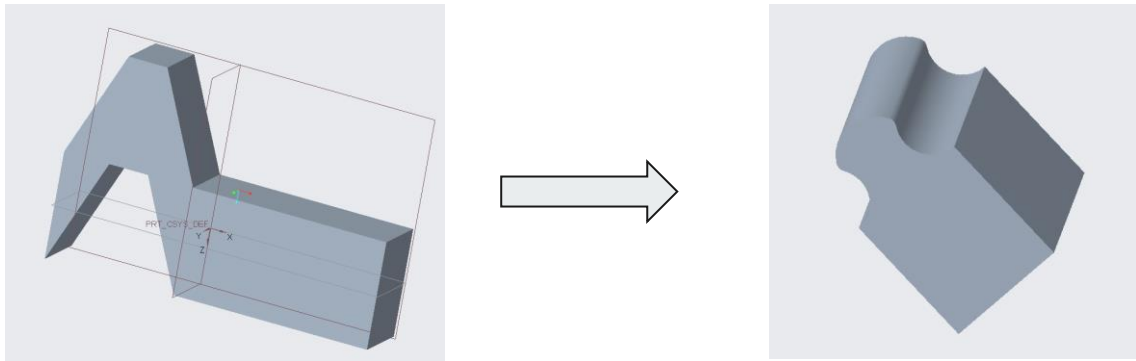

Figure 7, Iterations of the Zipper

## Results

After the iteration process, the DOE and the DFA, the final prototype was created considering all the results learnt. One of the main things that had to be changed from the last prototype made, was the accuracy of the gears. This was solved by laser cutting the gears instead of 3D printing them. Also, thanks to the DOE, a spring with certain characteristics was used to maximise the displacement of the machine. Also, the esthetic of product played an important role in the final prototype (a product that may be available in the market, apart from being useful, must be physically attractive). That is why the support structure has been made of acrylic instead of wood.

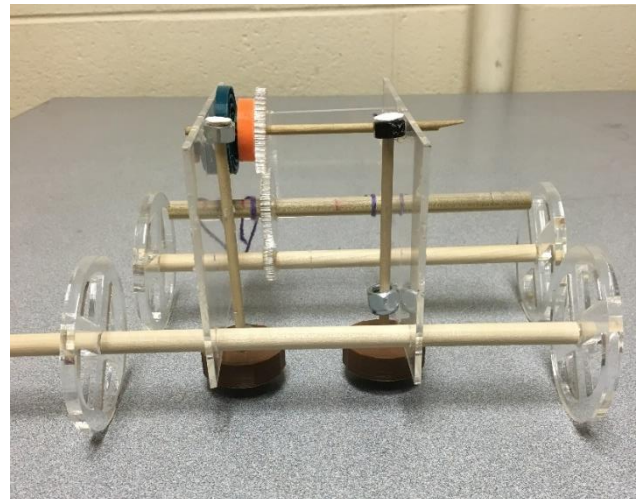



Figure 8, Final Prototype

## **Conclusion**

One of the most important aspects learnt during the development of this project is that trial and error tests are the most efficient way to do projects of this type. Although some features must be worked in the future (it was too big to be used in a real zipper), the main features (engineering ones) have been achieved. Also, an innovative product has been developed because common problems can have unconventional solutions.

## Index

1. Introduction .....	5
2. Background research .....	7
3. Objectives .....	9
4. Design Development .....	11
A. Ideation.....	11
B. Prototype 1 .....	12
I. Design description.....	12
II. CAD design .....	12
III. Pros and cons.....	13
C. Prototype 2 .....	13
I. Design description.....	13
II. CAD design .....	14
III. Pros and cons.....	15
D. Prototype 3 .....	15
I. Design description.....	15
II. CAD design .....	16
III. Pros and cons.....	17
E. Prototype 4 .....	18
I. Design description.....	18
II. CAD Design .....	19
III. Functioning of the clockwork system .....	20
IV. Pros and cons.....	21
F. Idea 5 .....	21
I. Design description.....	21
II. Pros and cons.....	22
G. Prototype 5 .....	22
I. Design Description.....	22
II. CAD Design .....	23

III. Pros and cons.....	24
IV. DOE: Design of experimentation and optimization .....	24
V. DFA: Design for assembly .....	31
H. Final prototype .....	34
5. Manufacturing cost.....	39
6. Resources .....	41
7. Management plan .....	43
8. Annex: Manufacturing techniques .....	45

## Index of Figures

Figure 1, Wind Up Toy .....	7
Figure 2, Zipper Helper .....	7
Figure 3, Sketch First Prototype.....	12
Figure 4, Bevel Gears.....	12
Figure 5, Sketch Second Prototype .....	13
Figure 6, Teeth of the outgoing parts .....	14
Figure 7, Teeth of the zipper .....	14
Figure 8, Assembly of Gears 1 and 2 .....	14
Figure 9, Wheels 3 and 4.....	15
Figure 10, Prototype 3.....	16
Figure 11. Metal Sping.....	16
Figure 12, Assembly in Creo of Prototype 3 .....	16
Figure 13, New design of the zipper .....	17
Figure 14, Wheels to push the zipper together .....	17
Figure 15, Prototype 4.....	18
Figure 16, Clockwork System.....	18
Figure 17, Upper-ratchet .....	19
Figure 18, Lower-ratchet.....	19
Figure 19, Key.....	19
Figure 20, Spring.....	19
Figure 21, Main Gear .....	20
Figure 22, Parts of a Clockwork System.....	20

Figure 23, Laser Cut Gear .....	21
Figure 24, New Sketch .....	22
Figure 25, Prototype 5 .....	23
Figure 26, Assembly Prototype 5 .....	23
Figure 27, Engineering Drawing for the Gears .....	23
Figure 28, Formula to Calculate Cumulative Probabilities .....	27
Figure 29, Plot for Main Effects.....	27
Figure 30, Plot for Noise Effects.....	29
Figure 31, Cumulative Probability Plot for Residuals.....	31
Figure 32, Alpha and Beta.....	32
Figure 33, Final prototype (1) .....	34
Figure 34, Final prototype (2) .....	35
Figure 35, Final prototype (3) .....	35
Figure 36, CAD Design Support Strucutre.....	36
Figure 37, Engineering Drawing Suppor Structure .....	36
Figure 38, Engineering Drawing Main Gears .....	36
Figure 39, Big and Small Gears .....	37
Figure 40, Waterfall Budget .....	41
Figure 41, Management Plan.....	43
Figure 42, 3D printer .....	46
Figure 43, CAD model vs printed part .....	46
Figure 44, drill machine .....	47
Figure 45, CAD model vs. machined part.....	48
Figure 46, injection molding machine.....	49
Figure 47, CAD model .....	49
Figure 48, Pressure Prediction.....	50
Figure 49, Cam Block Mold.....	51
Figure 50, Injection Molded Part.....	51
Figure 51, Spiral .....	52
Figure 52, Distance vs. Temperature.....	52
Figure 53, Distance vs. Pressure.....	53
Figure 54, Laser Cutting.....	54

## Index of Tables

Table 1, Variables for the DOE.....	24
-------------------------------------	----

Table 2, Results of the the DOE.....	25
Table 3, Main effects.....	25
Table 4, Ranked main effects and its probabilities.....	27
Table 5, Noise effects.....	28
Table 6, Ranked noise effects and its probabilities .....	29
Table 7, Predicted and Residual Values.....	30
Table 8, Ranked Residuals and its Probabilities .....	30
Table 9, DFA Analysis.....	33
Table 10, Manufacturing Costs .....	39
Table 11, Data Obtained after Performing Trials.....	52
Table 12, Percentage Difference Between Experimental Result and High Confidence of Fill.....	53



## 1. Introduction

This project consists in the design of a product (Zipper Climber) that will do/ undo zippers in hard to reach places. This project is very creative (you cannot find it in the market) and challenging. To make this device move, the first idea was to use motors, but as it was not creative enough (it was easy to know how to implement it), a new idea came up, it consisted in using a clockwork system instead of the motors. It is necessary to do a research to understand how this system works, so it would be harder too.

Many people around the world, especially women, have clothes whose zippers are located in the back where it is hard to reach them. It does not matter where these people are from, or their culture, or their ages, because anyone can use them. However, this device will be more used in developed countries than in developing countries, due to the fact that most people living in developing countries will not have many clothes whose zippers are in the back, so they will not need the zipper climber. Furthermore, this device is not considered a vital good, which means that people living in developing countries will not buy it.

This device can also be helpful for disabled people. This people have hard time zipping up zippers because they cannot hold the fabric down as well as zip the zipper up.

Therefore, it can be assumed that the main target group for the zipper climber is women and disabled people living in developed countries.



## 2. Background research

After doing a brainstorming and deciding what project to do, a background research was necessary to understand better if similar products were available in the market. Therefore, a research was done to find similar products and also, which products could have a similar approach in the mechanism parts.

The first idea for the project was to create a device that resembles a wind-up spider toy (Figure 1). The idea was that the legs of the spider would climb the zipper.



Figure 1, Wind Up Toy [Source: [https://i5.walmartimages.com/asr/9c7e7f28-b522-4b27-afae-56a23dd1be06\\_1.6b35b33b4e19d93224a4de0724b04cb2.jpeg?odnHeight=450&odnWidth=450&odnBg=FFFFFF](https://i5.walmartimages.com/asr/9c7e7f28-b522-4b27-afae-56a23dd1be06_1.6b35b33b4e19d93224a4de0724b04cb2.jpeg?odnHeight=450&odnWidth=450&odnBg=FFFFFF)]

The Zipper Helper (Figure 2) was the closest product in the market whose goal is similar to the “Zipper Climber”. However, this product allows the user to manually zip up zippers with the loop attached to the string. This is a similar way of solving the problem, but it is not mechanical. With this project, anyone would be able to zip their zippers, without holding the fabric.



Figure 2, Zipper Helper [Source: <https://images-na.ssl-images-amazon.com/images/I/61elMqcOV+L.jpg>]



### 3. Objectives

This project is aimed to achieve to zip up zippers without the help of a hand to anyone who wants to use it. Although the main goal is to achieve this purpose, there are many other goals that consequently will be accomplished:

- ✓ Make an innovative product that does not exist in the market.
- ✓ Use two or more mechanical parts for the performing of the project.
- ✓ Help people whose zippers are located in places that are hard to reach.
- ✓ Help disabled people to zip their zippers up without the help of anyone else.



## 4. Design Development

### A. Ideation

Before coming up with an idea for this project, a brainstorming was done and then the best and most creative idea was chosen. Ideas that could be useful for people in different situations was the main purpose. Some ideas required a large budget, and others did not make a big difference to the users. Some of these were: a wheelchair that helps people stand up (it could be very helpful to many people, however, there was not enough budget to design it, as the wheelchair is very big). Other idea was a solution to melting chocolate, so that the user does not have to stir the chocolate all the time. However, in this design not all the parts interacted with each other and there were not many mechanical parts, so it did not meet all the requirements.

After lot of thinking, the idea used for this senior design project came up. It was a great idea because at the moment of the ideation, the solution was not clear, which meant that it required a lot of research to design it. Furthermore, the clockwork system was very challenging.

A SWOT analysis to identify the strengths, weaknesses, opportunities and threats for my final design was done:

- Strengths: it would help people who did not have full use of both arms to zip their zippers with no assistance. It is also an innovative and different way to zip zippers.
- Weaknesses: there are many types of zippers, so it will not work for every type of cloth.
- Opportunities: there are a lot of disabled people and there needs to be more products to help them. Since the product is not extremely large, it would be relatively inexpensive and accessible to more people.
- Threat: finding a way to give enough energy to the device so that it can move through the whole zipper.

## B. Prototype 1

### I. Design description

The first prototype consisted in using a clockwork system and bevel gears to create the motion of the machine, as shown in Figure 4. The legs of the spider would be extruded from the back of the red and blue gears as shown in Figure 3. These gears would almost resemble a shoulder and would “climb” up the zipper. All of the gears would be encased in a “shell” which would have a loop on the bottom, this loop would pull the zipper up when the machine climbed up.

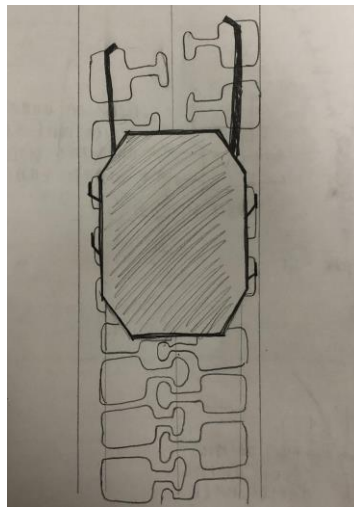

Figure 3, Sketch First Prototype

### II. CAD design



Figure 4, Bevel Gears [Source: <http://growerunited.com/wp-content/uploads/2016/04/BEVEL-GEAR-2.jpg>]



### III. Pros and cons

This was the first idea that accomplished a solution for this problem, however, at this point, 3D Printing technique had not been taught yet. Once it was taught, it could be seen that making pieces of the size of a zipper would be impossible. The next approach required to be able to design the zipper at a determined size and design the product according to the size of this zipper.

#### C. Prototype 2

##### I. Design description

Prototype 2 could be done at any size unlike Prototype 1. The zipper and the product would be designed. The important aspect was to have a solution, no matter the scale used.

In this design, a clockwork system was still be used. Gear 1 is the main gear powering the system. The clockwork system will be attached on this gear. Gears 1 and 2 and gears 3 and 4 will be attached by a stick, as shown in Figure 5, so that the distance between them is fixed. However, gears 1 and 3, and gears 2 and 4 will be attached by bands. The purpose of the bands is similar to a chain. If gear 1 rotates, although it is not in touch with gear 3, this one will rotate as well. The same happens with gears 2 and 4.

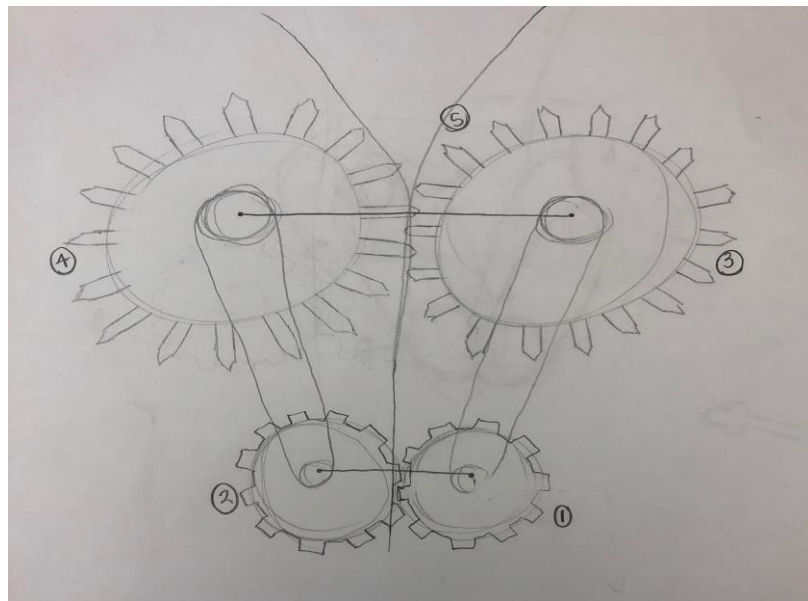

Figure 5, Sketch Second Prototype

The gears will have on the outgoing parts some sharp teeth. The bands will have holes that will fit these teeth, to make the wheels rotate, as shown in Figure 6.



Figure 6, Teeth of the outgoing parts

## II. CAD design

The following Figures show the three designs, done with Creo and printed in the Innovation Studio.

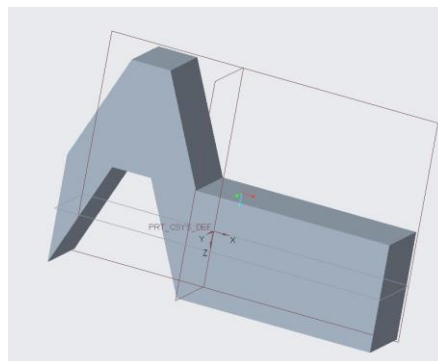

Figure 7, Teeth of the zipper

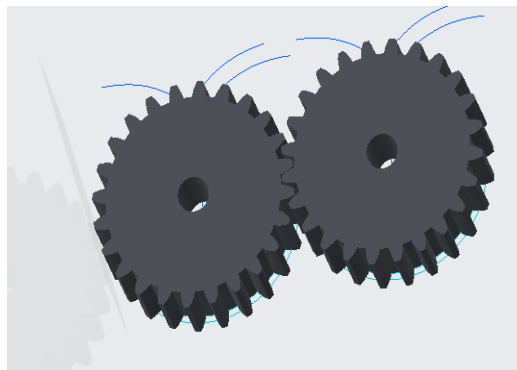

Figure 8, Assembly of Gears 1 and 2



Figure 9, Wheels 3 and 4

### III. Pros and cons

Although this idea, at first sight seemed that could work, once all the parts were printed it could be seen that it would be very hard to push the zipper pieces together with the wheels. The arms of the wheels were not correctly designed to achieve this goal, and it would be very hard to accomplish it because we would need the exact dimension of the wheel so it can fit between the spaces of the zipper. Furthermore, the zipper pieces were very tall in the y direction, so the front edges were getting stuck to each other very easily.

### D. Prototype 3

#### I. Design description

This is the first prototype designed with a support structure. The metal spring that is on the left gear (Figure 10), would create the movement. Pulling the end of the spring and then release it was the first thought, so the energy stored would make the gears rotate. The support structure looked like a “car”, on the bottom there would be small wheels, so that the whole support could move with the energy from the spring. Once the gears start rotating, the brown wheels would rotate as well (they would be attached by bands). The brown wheels would be the ones pushing the zipper pieces together. In this prototype, the design of the zipper was changed. The new design looked more like a conventional zipper than the other one. Moreover, with these new pieces, it would be easier to zip up the zipper because the front edges will not get stuck to each other.

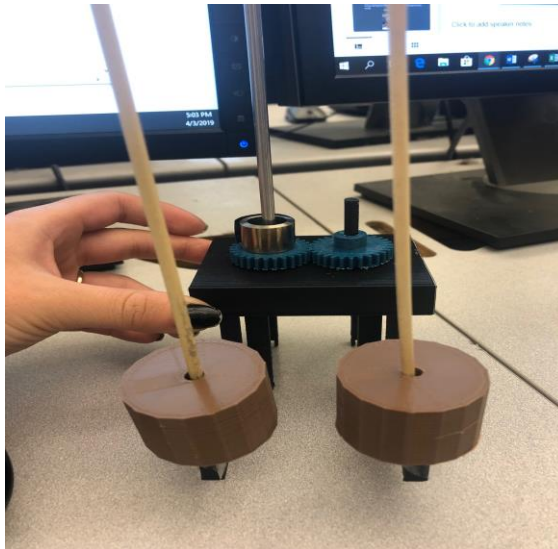

Figure 10, Prototype 3



Figure 11. Metal Sping

## II. CAD design



Figure 12, Assembly in Creo of Prototype 3

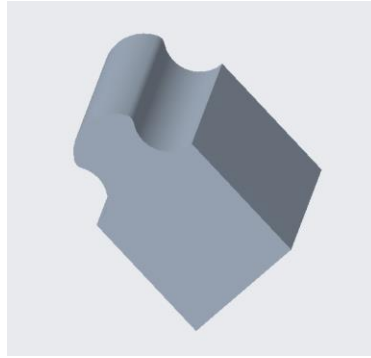

Figure 13, New design of the zipper

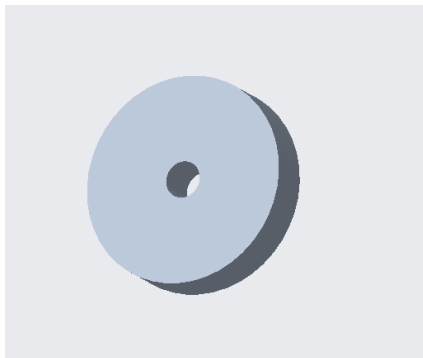

Figure 14, Wheels to push the zipper together

### III. Pros and cons

The prototype was not very effective. Very tall zipper pieces were needed so they could fit with the wheels (the wheels were placed at a given height). Furthermore, the metal spring was very hard to manipulate. The problem was that once the spring was released, it would come to the initial position so fast, that there would not be enough time to zip the whole zipper up.

Also, the whole support was not very stable, so it could fall with any movement.

Although this prototype was not used, one main idea from this one was, for the next prototype. The idea was using wheels instead of wheels with arms to push the pieces together, as well as using the second design of the zipper instead of the first one.

## E. Prototype 4

### I. Design description

In this prototype, the design has been simplified incredibly. This design uses a key and a ratchet to power the gears using a clockwork system. The user will wind the gears back and the ratchet will catch the motion, storing the energy of the spring (because the spring will be compressed) until someone releases the spring. In that moment, the ratchet will have stored energy, and the motion will spread to all the gears, and everything will start to move. Once the gears start moving, the two sticks attached to the brown wheels would rotate as well, thus, the brown wheels would move. Thanks to the friction between the brown wheels and the zipper, the whole device would move forward, pushing the pieces of the zipper together.

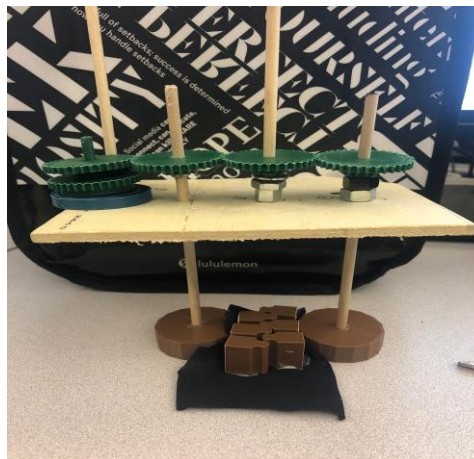

Figure 15, Prototype 4

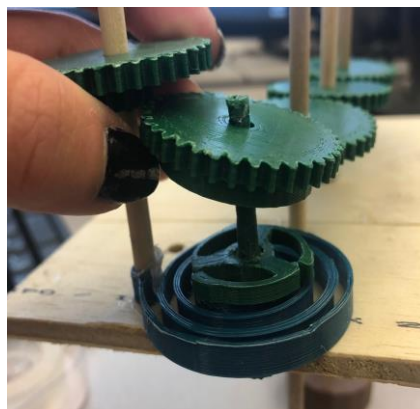

Figure 16, Clockwork System

## II. CAD Design

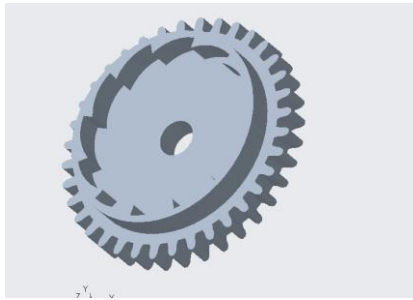

Figure 17, Upper-ratchet



Figure 18, Lower-ratchet

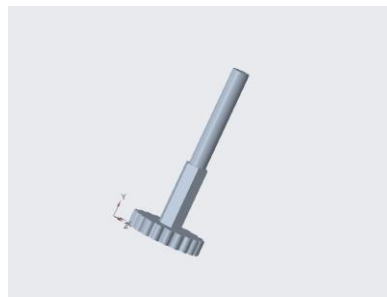

Figure 19, Key

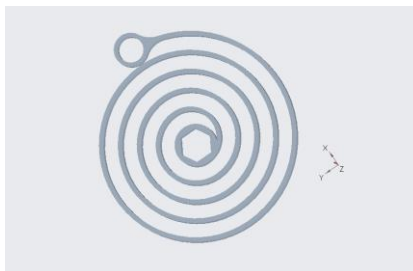

Figure 20, Spring

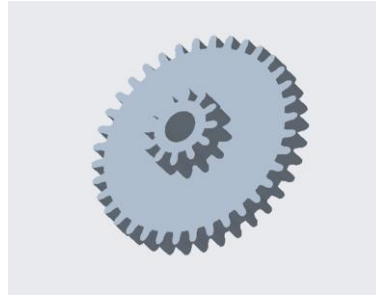

Figure 21, Main Gear

### III. Functioning of the clockwork system

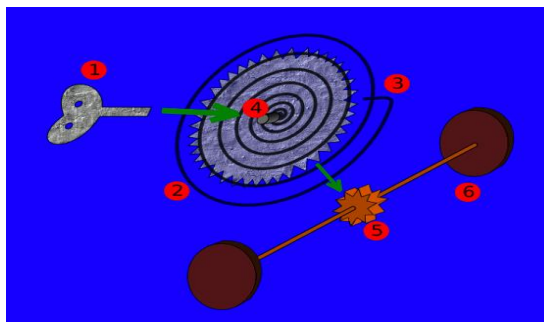

Figure 22, Parts of a Clockwork System [Source:

[https://www.bing.com/images/search?view=detailV2&id=0DB10EEB2D03E3C2922FB60648CFDBDC77B8E570&thid=OIP.9GPgf7mDhRUCTzQ6simQpgHaFq&mediarurl=https%3A%2F%2Fs-media-cache-ak0.pinimg.com%2F736x%2F8c%2F23%2Ffc3%2F8c23c3d14a3f3a3c86871002d16e32f3.jpg&exph=428&expw=560&q=parts+of+a+wind+up+toy&selectedIndex=25&qft=+filterui%3acolor2-FGcls\\_BLUE&ajaxhist=0&vt=0&eim=1,2,6\]](https://www.bing.com/images/search?view=detailV2&id=0DB10EEB2D03E3C2922FB60648CFDBDC77B8E570&thid=OIP.9GPgf7mDhRUCTzQ6simQpgHaFq&mediarurl=https%3A%2F%2Fs-media-cache-ak0.pinimg.com%2F736x%2F8c%2F23%2Ffc3%2F8c23c3d14a3f3a3c86871002d16e32f3.jpg&exph=428&expw=560&q=parts+of+a+wind+up+toy&selectedIndex=25&qft=+filterui%3acolor2-FGcls_BLUE&ajaxhist=0&vt=0&eim=1,2,6])

Figure 22 shows the parts of a clockwork system. The user will wind back the key (part 1), which will compress the spring (part 2), storing the energy. Once the user stops winding, the spring will decompress, making the main gear (part 3) rotate, that will fit with the secondary gear (part 5), so the rest of the parts (part 6) will receive the power to move. However, using only the parts shown in Figure 22, will make very hard to wind the key many times, because once the user tries to twist it again, the spring will automatically release. To solve this problem, a ratchet was used, comprised of two different parts (upper-ratchet and lower-ratchet), shown in Figures 17 and 18. Thanks to the ratchet, when the user winds the key back, the energy stored is kept, until the user releases the ratchet (the ratchet must be fixed until the user wants the device to start moving).



#### IV. Pros and cons

The main issue with this prototype is the accuracy of the gears, since they are so small, it was not possible to remove the support material out without compromising the geometry of the gears. As a result, the gears did not fit together correctly and were tipping which made very difficult the rotation, and the friction increased. Also, there was too much friction between the wheels and the floor, which hindered the movement.

#### F. Idea 5

##### I. Design description

The inaccuracy of the gears was a big issue that needed to be solved in order to make the prototype work. After some research, laser cutting was the best method, instead of 3D printing.



Figure 23, Laser Cut Gear

Figure 24 shows the new sketch made. This sketch helps to solve one of the main problems found with the last prototype (the friction between the main wheels and the ground). Two different wheels can be differentiated in this new sketch. The main wheels (yellow wheels) and the secondary wheels (pink wheels). The main ones will make the structure move while the secondary wheels will push the pieces of the zipper together. In this way, it is easier to make it move because the yellow wheels are positioned vertically instead of horizontally (like a normal car wheel).

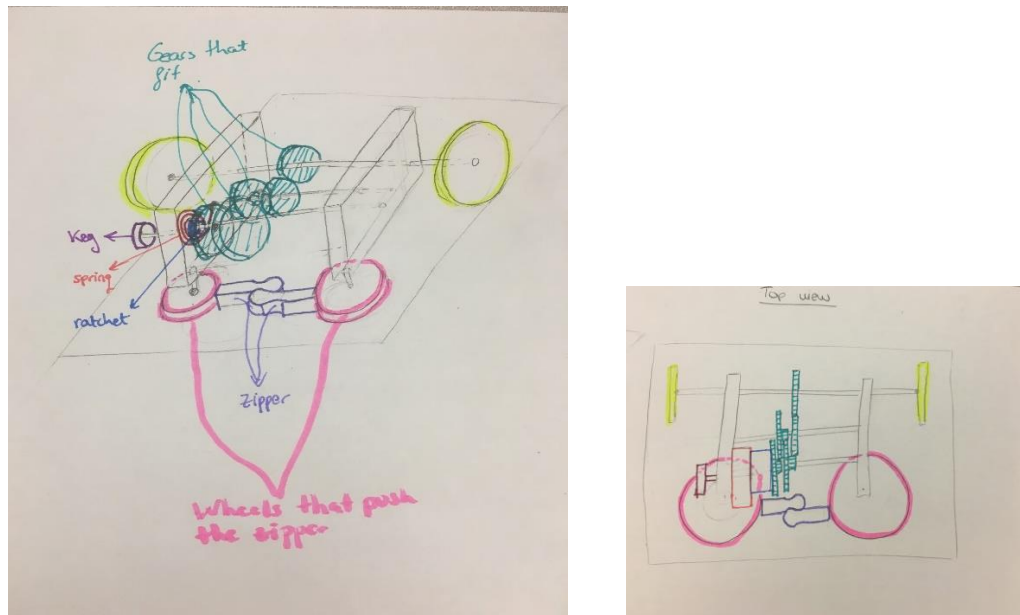

Figure 24, New Sketch

## II. Pros and cons

This sketch is very similar to the final one. It has many advantages, such as the position of the main wheels and the accuracy of the gears. However, the friction of the secondary wheels could be very high and make the movement of the device more difficult.

## G. Prototype 5

### I. Design Description

This prototype is very similar to the final one. It resembles a car toy, but it also has two wheels attached to it to push the pieces of the zipper together. The idea of this prototype is that with the energy from the clockwork system, the gears rotate. One of the two axis of the main wheels will have a gear attached to it. So, when the gears rotate, this axis will rotate as well, and the two main gears will move the whole structure.

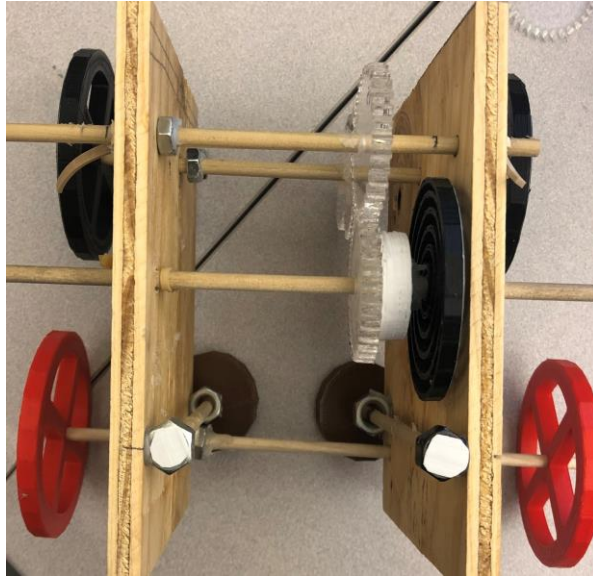

Figure 25, Prototype 5

## II. CAD Design

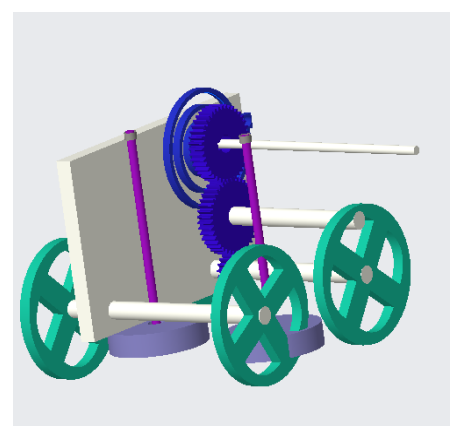
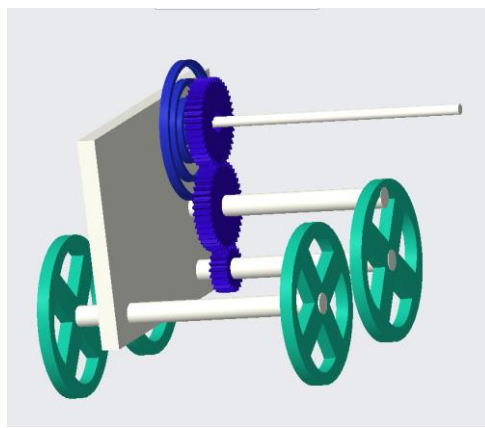
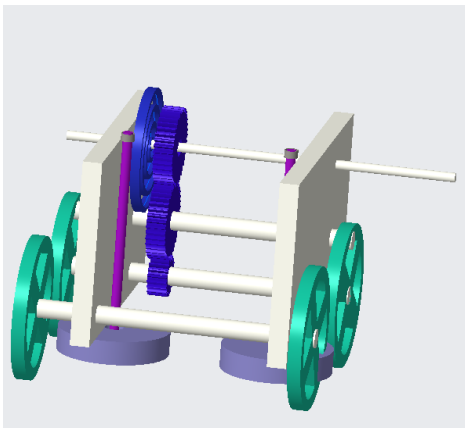

Figure 26, Assembly Prototype 5



Figure 27, Engineering Drawing for the Gears

### III. Pros and cons

This prototype was the best solution to solve the issue, however there were some aspects that needed to be changed to improve the design. The support was made of wood, so the wholes where the axis passed through had to be drilled. For this reason, it was very difficult to have wholes with the perfect dimension for the axis. Also, the main wheels where 3D printed, so they were not perfectly rounded, which made the movement harder.

### IV. DOE: Design of experimentation and optimization

DOE is a method used to improve some aspects of a design. In this case, the main thing to optimize is the distance that the machine could go. In order to have a successful product to zip up a zipper, the product must make it all the way up the zipper. To do this method, the first thing to do is thinking about what variables should be improved. The spring used in the first prototype did not store a lot of energy, due to the small size. So, the first variable used was the coil distance. The low level was the spring with 5 coils and 1mm distance between each coil and the high as the spring with 6 coils and 4 mm between each coil. The wheels that pushed the pieces of the zipper together (secondary wheels), were not completely rounded, which could make the rotation harder. Therefore, the second variable chosen was the wheel material. Low would be the secondary wheels unsanded, while high would be the secondary wheels sanded (to make them rounder). Another issue was that sometimes, the main wheels slipped on the ground, so the third variable was the main wheel surface. Low was main wheels without rubber bands on it, while high was wheels with rubber bands on it. Since the goal was to make the device move further, the DOE was measured on millimeters up the zipper that the machine travelled. As a reference, there was a line as a zero point. Once the machine has moved to its final position, measurements were taken from the zero to the foremost axis to find its displacement.

<b>Variable</b>	<b>Description</b>	<b>Low level (-1)</b>	<b>High level (1)</b>
X1	Coil distance	1mm	4 mm
X2	Secondary wheel material	Bare	Sanded
X3	Main wheel surface	Bare	Rubber bands

Table 1, Variables for the DOE

Eight different tests were taken, three times for each test:

These were the results:

Test	x1	x2	x3	x1x2	x1x3	x2x3	x1x2x3	y1	y2	y3	yave	StdDev	Variance
1	-1	-1	-1	1	1	1	-1	22.2	21.5	25.2	23	1.97	3.86
2	-1	-1	1	1	-1	-1	1	50.2	48.2	45.6	48	2.31	5.34
3	-1	1	-1	-1	1	-1	1	21.3	20.5	22.3	21.4	0.9	0.81
4	-1	1	1	-1	-1	1	-1	45.4	47.5	42.7	45.2	2.41	5.79
5	1	-1	-1	-1	-1	1	1	25.2	23.7	22.6	23.8	1.31	1.7
6	1	-1	1	-1	1	-1	-1	80.5	75.6	77.3	77.8	2.49	6.19
7	1	1	-1	1	-1	-1	-1	24.3	21.7	23.3	23.1	1.31	1.72
8	1	1	1	1	1	1	1	75.5	74.5	74.2	74.7	0.68	0.46

Table 2, Results of the the DOE

Yave is the mean of y1, y2 and y3 for each test.

Std Dev. is the standard deviation, it is calculated using with Excel, the function: STDEV(y1:y3). The variance is the square of the standard deviation.

E1	E2	E3	E12	E13	E23	E123
15.48	-2.06	38.63	0.16	14.18	-0.89	-0.28

Table 3, Main effects

E1, E2 and E3 are the main effects, it means, the average effect of each variable. They are calculated multiplying the sign of each variable by the Yave and then dividing it by the half number of tests.

- $$E1 = \frac{1}{4} * [(-1 * 23) + (-1 * 48) + (-1 * 21.4) + (-1 * 45.2) + (1 * 23.8) + (1 * 77.8) + (1 * 23.1) + (1 * 74.7)] = 15.48$$
- $$E2 = \frac{1}{4} * [(-1 * 23) + (-1 * 48) + (1 * 21.4) + (1 * 45.2) + (-1 * 23.8) + (-1 * 77.8) + (1 * 23.1) + (1 * 74.7)] = -2.06$$
- $$E3 = \frac{1}{4} * [(-1 * 23) + (1 * 48) + (-1 * 21.4) + (1 * 45.2) + (-1 * 23.8) + (1 * 77.8) + (-1 * 23.1) + (1 * 74.7)] = 38.63$$

These three effects indicate on average, what happens when one variable is moved from the low level to the high level. For example, E1 indicates that when variable 1 is moved from low level to high level there is an increase in the displacement. The number

sign indicates if the effect is positive or negative and the magnitude indicates the strength of the effect.

E12, E13, E23 and E123 are interaction effects.

- $E12 = \frac{1}{4} * [(1 * 23) + (1 * 48) + (-1 * 21.4) + (-1 * 45.2) + (-1 * 23.8) + (-1 * 77.8) + (1 * 23.1) + (1 * 74.7)] = 0.16$
- $E13 = \frac{1}{4} * [(1 * 23) + (-1 * 48) + (1 * 21.4) + (-1 * 45.2) + (-1 * 23.8) + (1 * 77.8) + (-1 * 23.1) + (1 * 74.7)] = 14.18$
- $E23 = \frac{1}{4} * [(1 * 23) + (-1 * 48) + (-1 * 21.4) + (1 * 45.2) + (1 * 23.8) + (-1 * 77.8) + (-1 * 23.1) + (1 * 74.7)] = -0.89$
- $E123 = \frac{1}{4} * [(-1 * 23) + (1 * 48) + (1 * 21.4) + (-1 * 45.2) + (1 * 23.8) + (-1 * 77.8) + (-1 * 23.1) + (1 * 74.7)] = -0.28$

These effects indicate how the correlation between two variables affect the displacement.

To demonstrate the significant effects, a statistical method is used. To do so, three values are needed:

- Average system variance: 3.23
- System standard deviation (square root of average system variance): 1.8
- 2 sigma threshold (system standard deviation multiplied by 2): 3.6

Any effect larger than 3.6 in magnitude is statistically significant for the process. Which means that E1, E3 and E13 are significant for predicting the displacement of the machine. However, this study can go further, and a graphical method can be applied to demonstrate the effect values. To do so, the y-axis will be the effect value, while the x-axis will be the standard deviation of the cumulative probability. To calculate the cumulative probability, the following formula is used:

$$P_i = \left( \frac{100 * (i - 0.5)}{2^n - x} \right)$$

Figure 28, Formula to Calculate Cumulative Probabilities

Where  $(2^n - x)$  is the number of division we need to make, in this case, 7 and  $i$  is the rank of the effect. To calculate the standard deviation of the cumulative probability, the following formula in Excel is used:

DISTR.NORM.INV(Prob;mean(=0);standard\_deviation(=1))

Rank	1	2	3	4	5	6	7
y-axis	-2.06	-0.89	-0.28	0.16	14.18	15.48	38.63
Prob	0.07	0.21	0.36	0.50	0.64	0.79	0.93
x-axis	-1.47	-0.79	-0.37	0.00	0.37	0.79	1.47
Effect	E2	E23	E123	E12	E13	E1	E3

Table 4, Ranked main effects and its probabilities

A set of points near zero is selected to create a trend line on the graph. Any effect above the line in the right half plane or below the line in the left half plane is considered graphically significant, therefore, E13, E1 and E3 are significant, as predicted using the statistical method.

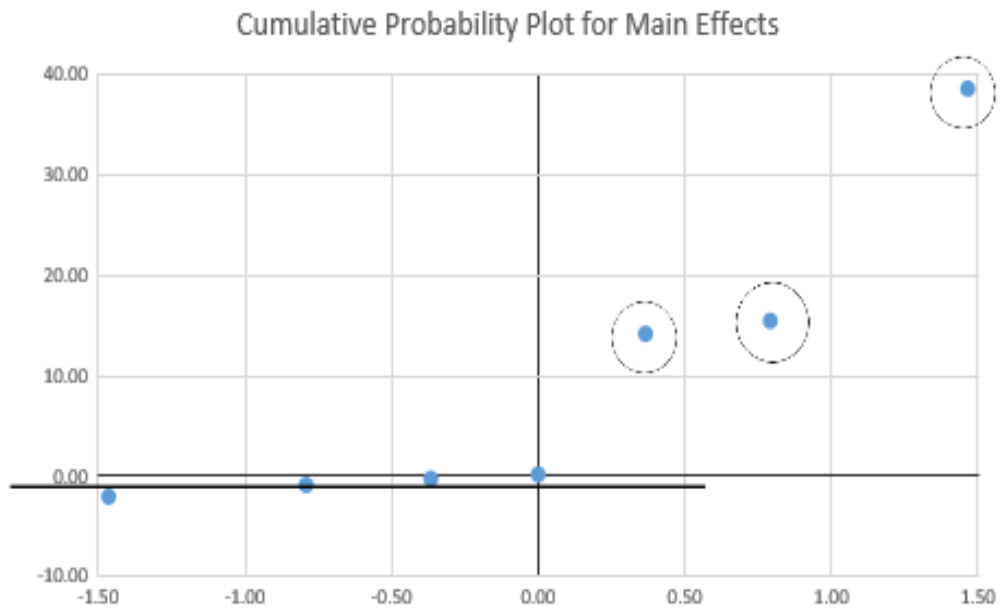

Figure 29, Plot for Main Effects

The reduced characteristic equation to predict the input would be as follows (SystemYAverage is the mean of all the outputs), just considering the significant ones:

$$y = \text{SystemYAverage} + \frac{E1}{2} * x1 + \frac{E3}{2} * x3 + \frac{E13}{2} * x1 * x3 =$$

$$42.13 + \frac{15.48}{2} * x1 + \frac{38.63}{2} * x3 + \frac{14.18}{2} * x1 * x3$$

In order to maximize the output (y=displacement), x1 and x3 must be maximized. So, x1 will be the spring with a coil difference of 4 mm and the x3 will be the main wheel surface with rubber bands, however the variable x2 did not make a big difference. That is why its effect is not significant and does not appear in the reduced characteristic equation.

E1	E2	E3	E12	E13	E23	E123
-1.43	-2.94	2.42	-0.78	-0.81	-0.56	-2.31

Table 5, Noise effects

To calculate the noise effects, the same procedure is followed, but multiplying by the variance, instead of by the Yave.

- $E1 = \frac{1}{4} * [(-1 * 3.86) + (-1 * 5.34) + (-1 * 0.81) + (-1 * 5.79) + (1 * 1.7) + (1 * 6.19) + (1 * 1.72) + (1 * 0.46)] = -1.43$
- $E2 = \frac{1}{4} * [(-1 * 3.86) + (-1 * 5.34) + (1 * 0.81) + (1 * 5.79) + (-1 * 1.7) + (-1 * 6.19) + (-1 * 1.72) + (1 * 0.46)] = -2.94$
- $E3 = \frac{1}{4} * [(-1 * 3.86) + (1 * 5.34) + (-1 * 0.81) + (1 * 5.79) + (-1 * 1.7) + (1 * 6.19) + (-1 * 1.72) + (1 * 0.46)] = 2.42$
- $E12 = \frac{1}{4} * [(1 * 3.86) + (1 * 5.34) + (-1 * 0.81) + (-1 * 5.79) + (-1 * 1.7) + (-1 * 6.19) + (1 * 1.72) + (1 * 0.46)] = -0.78$



- $E13 = \frac{1}{4} * [(1 * 3.86) + (-1 * 5.34) + (1 * 0.81) + (-1 * 5.79) + (-1 * 1.7) + (1 * 6.19) + (-1 * 1.72) + (1 * 0.46)] = -0.81$
- $E23 = \frac{1}{4} * [(1 * 3.86) + (-1 * 5.34) + (-1 * 0.81) + (1 * 5.79) + (1 * 1.7) + (-1 * 6.19) + (-1 * 1.72) + (1 * 0.46)] = -0.56$
- $E123 = \frac{1}{4} * [(-1 * 3.86) + (1 * 5.34) + (1 * 0.81) + (-1 * 5.79) + (1 * 1.7) + (-1 * 6.19) + (-1 * 1.72) + (1 * 0.46)] = -2.31$

In general, when these effects have small magnitudes, they are probably not important.

Following the same procedure as before, if any effect is larger than 3.6 in magnitude, it will be considered significant. Therefore, there is no noise effects that could be considered significant, so there is no need to minimize the variance equation. To verify this statement, the graphical method has been used as well:

Rank	1	2	3	4	5	6	7
y-axis	-2.94	-2.31	-1.43	-0.81	-0.78	-0.56	2.42
Prob	0.07	0.21	0.36	0.50	0.64	0.79	0.93
x-axis	-1.47	-0.79	-0.37	0.00	0.37	0.79	1.47
Effect	E2	E123	E1	E13	E12	E23	E3

Table 6, Ranked noise effects and its probabilities

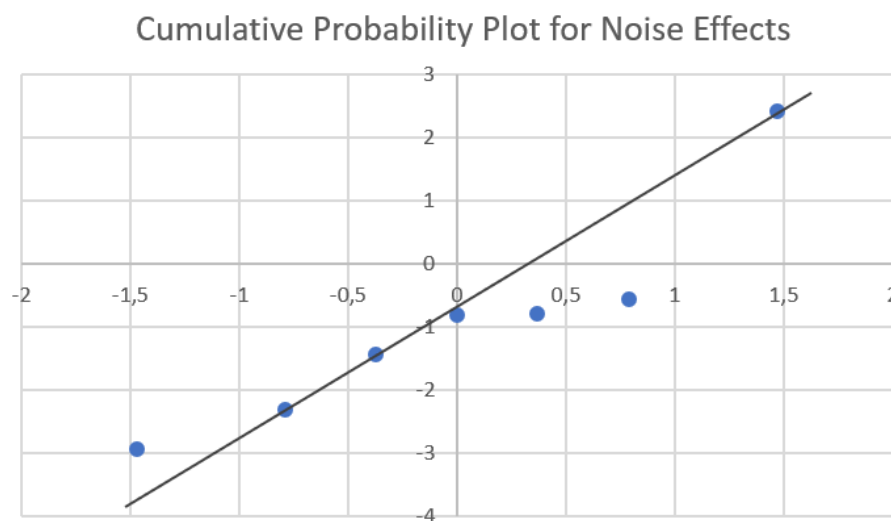

Figure 30, Plot for Noise Effects

There is not any effect above the line in the right half plane or below in the left half plane, so there are not significant noise effects. As there is not a variance equation, the main objective is to maximize the reduced characterized equation, which leads to set  $x_1$  as high and  $x_3$  as high (spring with a coil difference of 4 mm and main wheels with rubber bands). No matter the value given to  $x_2$ , as it barely affects the output.

However, to determine if a reduced model (characteristic equation with only significant effects included) is valid, the residuals for the model can be plotted:

The predicted number are calculated using the characteristic equation, and the residual is the difference between average and predicted:

Test	$x_1$	$x_2$	$x_3$	Average (Y)	Predicted ( $\hat{Y}$ )	Residual (e)
1	-1	-1	-1	23	22.17	0.83
2	-1	-1	1	48	46.62	1.38
3	-1	1	-1	21.4	22.17	-0.77
4	-1	1	1	45.2	46.62	-1.42
5	1	-1	-1	23.8	23.47	0.33
6	1	-1	1	77.8	76.28	1.52
7	1	1	-1	23.1	23.47	-0.37
8	1	1	1	74.7	76.28	-1.58

Table 7, Predicted and Residual Values

Following the same procedure as before, the cumulative probability and its standard deviation has been calculated:

Rank	1	2	3	4	5	6	7	8
y-axis	-1.58	-1.42	-0.77	-0.37	0.33	0.83	1.38	1.52
Prob	0.06	0.19	0.31	0.44	0.56	0.69	0.81	0.94
x-axis	-1.55	-0.87	-0.49	-0.15	0.15	0.49	0.87	1.55

Table 8, Ranked Residuals and its Probabilities

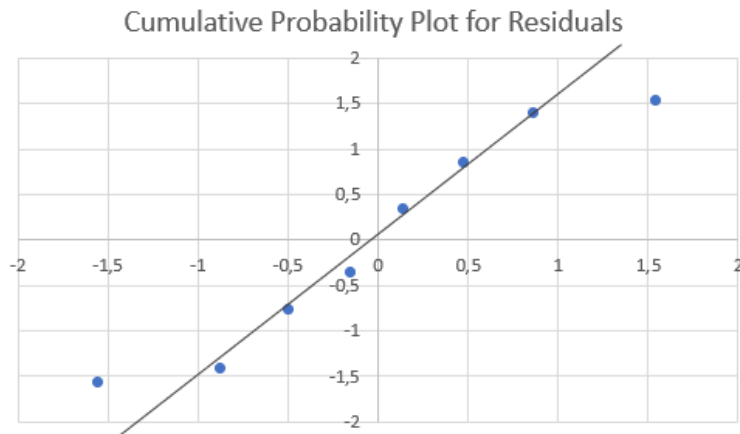

Figure 31, Cumulative Probability Plot for Residuals

As the points form roughly a straight line, it can be considered that the model is good, therefore, the predictions made can be applied and improvements will be noticed.

Throughout the DOE, the best trial was found (when wheels are banded with rubber bands and spring has 4 mm between the coils). The wheels being banded made the most difference (the effect was larger) but the spring played an important role as well. These two variables are going to be used to ensure the efficiency of the next prototype.

#### V. DFA: Design for assembly

Design for Assembly (DFA) is a method used to reduce the assembly cost by minimizing the time used for the assembly of any product. The time for setting all the parts in the correct position and the possible difficulties (small pieces, small holes, difficult alignments...) that increase the time are considered. With this process, someone can also learn if there are any parts that could be avoided because they are not necessary for the correct functioning of the device. Also, two different concepts have been learnt while doing this method (alpha and beta).

- Alpha: the number of degrees to rotate a piece in the perpendicular direction of insertion so that it fits again in the hole / pin.
- Beta: the number of degrees to rotate a piece in the direction of insertion so that it fits again in the hole / pin.

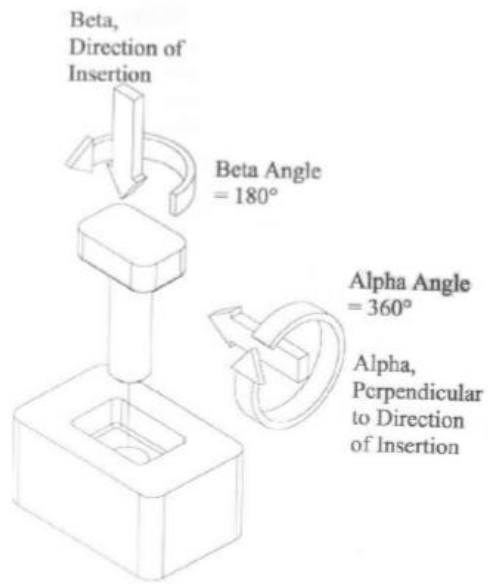

Figure 32, Alpha and Beta [Source: [http://homepages.cae.wisc.edu/~me349/lecture\\_notes/me349\\_dfa\\_lecture\\_notes.pdf](http://homepages.cae.wisc.edu/~me349/lecture_notes/me349_dfa_lecture_notes.pdf)]

All the pieces have size penalty and consequently, increase of time, due to the small size of each part.

The following table shows the alpha, beta and time (considering for each case the difficulties it may have when assembling it) for each piece of the Prototype 5.

Operation Number	Number Parts	Description	Alpha	Beta	Max Dim (mm)	Min Dim (mm)	Difficulty	Time (sec)
1	2	Support	360	360	150	10	X	5.6
2	1	Spring	360	360	66	5	Small Hole and Difficult Alignment	5.1
3	1	Lower-ratchet	360	0	24	4	Small Hole	3.7
4	1	Upper-ratchet	360	0	42	14	X	2.3
5	4	Main Gear	180	0	42	4	Small Hole	12.8
6	4	MainWheel	180	0	75	6.5	Two hands are required	12.8
7	2	Secondary Wheels	180	0	40	13	Two hands are required	3.6
8	2	Nuts	180	0	10	5	X	3.6
9	4	Axis	180	0	194	5	Very Thin	9.2

Table 9, DFA Analysis

Considering the DFA analysis, the total time obtained is 58.7 seconds. However, the real time used to assembly all the pieces together is much more. What the DFA has not taken into account is the need to use glue to stick some parts together. It takes time because waiting until the glues gets dry is necessary to continue with the assembly.

Considering the functions of each part, most of them belonged to the theoretical minimum number of parts (parts required for the correct functioning of the machine). However, some of them could have been avoided in order to reduce the assembly time and therefore, reduce costs. These parts are:

- In the Prototype 5 there were 4 main gears in total, however, it was not necessary so one gear was deleted. After this change, the next prototype had 3 gears.
- Also, the nuts were not necessary for the functioning of the project, however, they helped the structure to be more stable. In the final prototype,

instead of nut, rubber bands were used because they could be placed anywhere and was easier to assembly with this.

The remaining parts were completely necessary to make the prototype function correctly.

#### H. Final prototype

At a design level, the final prototype is very similar to prototype 5, but considering the results obtained in the DOE, DFA, and other changes that would improve the prototype.

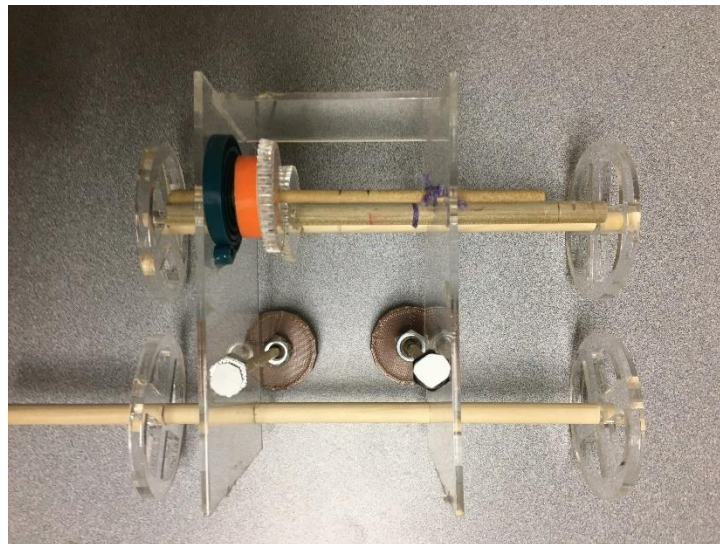

Figure 33, Final prototype (1)

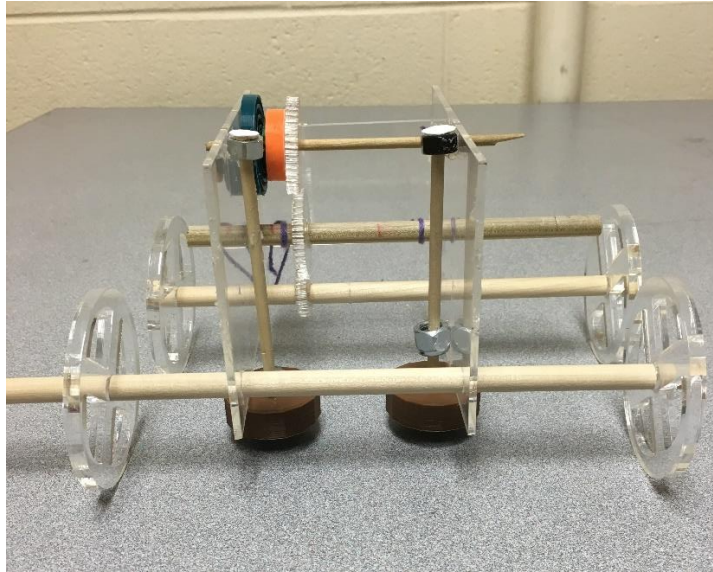

Figure 34, Final prototype (2)

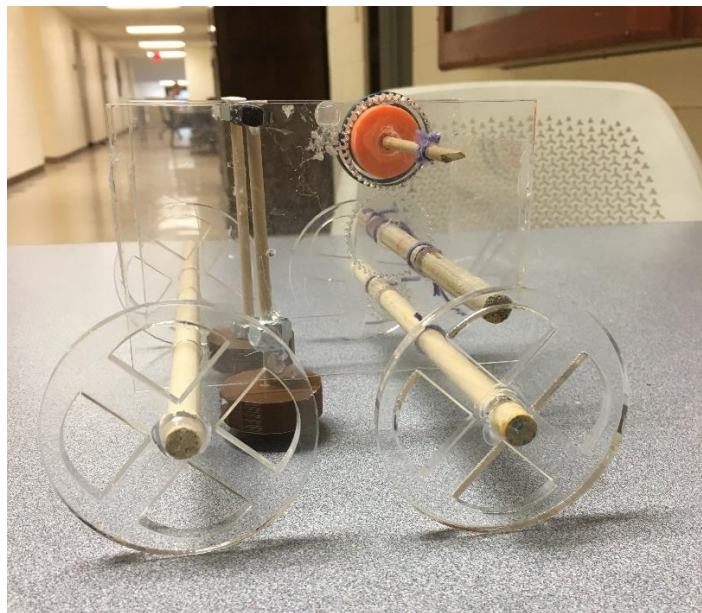

Figure 35, Final prototype (3)

The changes made in this, apart from the one found in the DOE prototype have been:

- The support structure has been laser cut instead of 3D printed to design the wholes where the axis passes through and make the prototype more attractive.

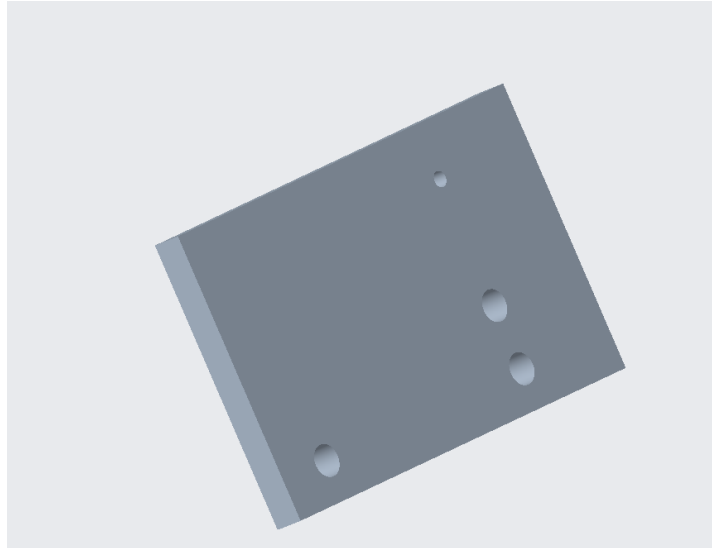

Figure 36, CAD Design Support Structure

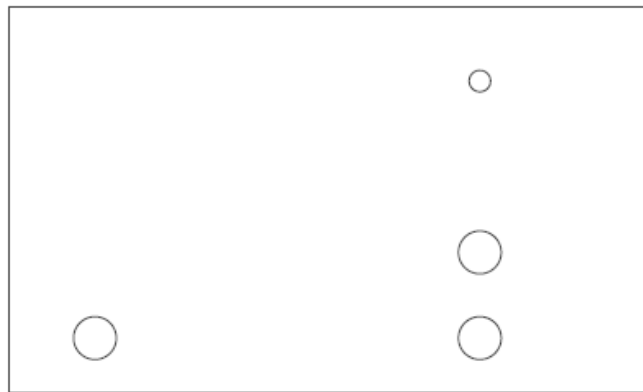

Figure 37, Engineering Drawing Support Structure

- The main gears have also been laser cut to make them rounder.

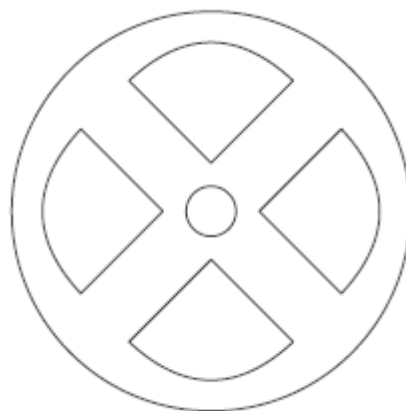

Figure 38, Engineering Drawing Main Gears



- A piece of acrylic between the two structures, because the last prototype was swinging which made the movement harder.
- Two different sized gears have been used, instead of just one sized gear. The reason of this, is to make the device move further. The small gear has 20 teeth, while the big one has 40 teeth. That means, it takes one revolution from the big gear to make the small one revolves twice. Using this engineering concept, if the big gear is connected to the clockwork system, the smaller one will move twice with the same energy stored in the ratchet.



Figure 39, Big and Small Gears

The benefits of laser cutting, apart from the accuracy, is that the final prototype is more appealing, so it looks more like a real / finish product.



## 5. Manufacturing cost

Apriori is a software used to calculate the manufacturing cost of a piece, depending on several variables. A prt file (Creo design) is uploaded in this program, afterwards, the user selects the material for that part, the volume of parts needed annually and the product life. Once all the inputs are set, Apriori will calculate an estimation of the manufacturing cost and the capital investment needed.

For all the CAD parts, the manufacturing cost has been calculated and the results were:

CAD part	Number of parts	Material used	Capital Investment (USD)	Cost per part (USD)
Axis (thick)	3	ABS	10,207.58	0.93
Axis (thin)	3	ABS	11,108.93	0.59
Main Wheels	4	Acetal Copolymer	10,788.43	0.98
Secondary Wheels	2	Acetal Copolymer	10,623.68	0.34
Main gear (big one)	2	Acetal Copolymer	8,839.47	1.13
Main gear (little one)	1	Acetal Copolymer	8,652.31	0.45
Spring	1	Polypropylene	10,940.57	0.3
Upper-ratchet	1	Acetal Copolymer	8,679.27	1.37
Lower-ratchet	1	Acetal Copolymer	8,431.84	0.24
Main support	2	ABS	13,196.50	1.41
Support Helper	1	ABS	10,543.51	0.75

Table 10, Manufacturing Costs

Looking upon the table, the manufacturing cost of the whole product would be \$17.35.

The main parts of the design will be made of Acetal Copolymer because this plastic is used to design pieces that need to be precise (the case of the gears) and require to have low friction, strength and rigidity. However, ABS has been chosen for the outer parts and the axis due to its impact resistance and toughness, that ensures a longer life of the product in case it falls down. Finally, Polypropylene has been used for the spring because this plastic not only is tough, resistant and light, but also flexible which is necessary for the spring to work.



## 6. Resources

To be able to complete the design of this prototype, some resources have been used. Mainly, the Innovation Study of the University of Illinois at Urbana-Champaign, to 3D print and laser cut all the pieces. In this place, many printers were available to print the desired parts in PLA (plastic considered biodegradable) and the required machine to laser cut the parts that needed to be accurate. Other rough materials and softwares have been used as well along the development of this prototype:

- Creo Parametric (to design all the pieces)
- Apriori (to predict the manufacturing cost of the materials)
- Excel
- Wood Glue
- Wood
- Cardboard

The University provided \$150 to spend in the University + \$50 to spend ordering online. In total, there were \$200 to spend in the prototype.

The following graph shows the dollars spent, divided by parts and rough material to understand better on what the dollars have been spent.

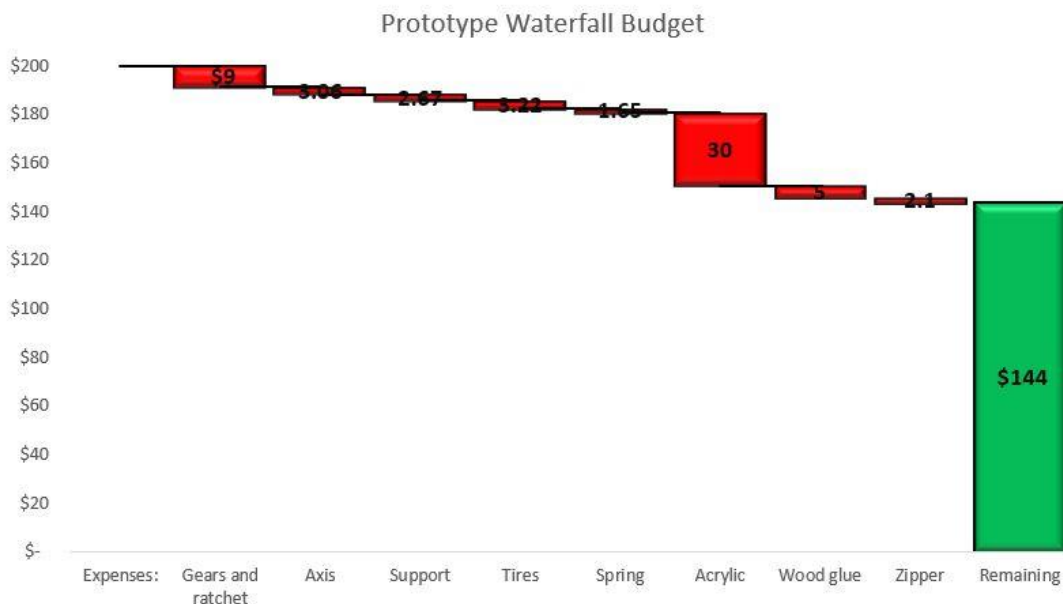

Figure 40, Waterfall Budget

- Gears and ratchet: \$8.57

- Axis: \$3.06
- Support: \$2.67
- Secondary wheels: \$3.22
- Spring: \$1.65
- Acrylic (used for laser cutting): \$30
- Wood glue: \$5
- Zipper: \$2.21
- Total spent: \$56.38
- Remaining: \$143.62

## 7. Management plan

For the development of this project, a management plan is required, to divide the work equitably in time, to ensure that the final prototype review will be done by 29<sup>th</sup> April.

Tasks	January 28	February 4	February 11	February 18	February 25	March 4	March 11	March 18	March 25	April 1	April 8	April 15	April 22	April 29
Brainstorming	█													
Background Research														
Project Proposal														
1st Prototype Idea														
Research Clockwork System		█												
First zipper design														
Design of the 1st Wheels														
Ideation 2nd Prototype			█											
Best Solution Clockwork System														
Design Review				█										
Ideation 3rd Prototype					█									
Design Main Gears														
Design Main Support														
Design Secondary Wheels						█								
Change Design of the Zipper							█							
Ideation 4th Prototype								█						
New Ideation for the Clockwork System									█					
Design of the ratchet										█				
Design of the spring											█			
Print all the parts												█		
Assembly 4th Prototype													█	
New Sketch for a New Idea														█
Prototype Review														
5th Idea														
Ideation 5th Prototype														
Design Gears														
Laser Cut Gears														
Design of Experiment														
Assembly 5th Prototype														
Ideation Final Prototype														
Design for Assembly														
Laser Cut Support														
Laser Cut Main Wheels														
Assmebly Final Prototype														
Final Prototype Review														█

Figure 41, Management Plan





## 8. Annex: Manufacturing techniques

During the semester different techniques have been learned that could be used for the design of this project. The techniques are the following:

### A. 3D Printing

There were three different techniques related to 3D printing that were analysed to find the advantages and disadvantages of each:

#### I. Stereolithography Apparatus (SLA):

This method has the highest resolution of the rapid prototyping methods and has the smoothest top surface. Although support structure is still needed in this method because the density of the cured resin is greater than the uncured, SLA needs less support structure than some other rapid prototyping methods. However, as support structure is needed, the removal of this is added to the post removal. The user must manually cut off the scaffolding (support). This method works by curing a layer of polymer resin with an ultraviolet light. However, the material produced from this is very hard and brittle, so it cracks easily.

#### II. Selective Laser Sintering (SLS):

In this method, support structure is not required, which is a great advantage (sometimes it is very hard to remove support structure and it adds time). In this process, a layer of powder about 10 mm thick is used. This powder is more chemically inert than other material used for rapid prototyping. This means that it is more stable and unresponsive which is very useful depending on what kinds of conditions the part will come in contact with. One limit of this process is that parts can only be created in white. In addition, as SLS uses powder, there is a static electric charge that comes with that. Due to this, “dust” continues to come off of surfaces even after brushing.

#### III. Fused Deposition Modelling (FDM):

This method is typically the largest volume and fastest fabrication. In addition, it is the most inexpensive. This process is also the best if the user needs different colors. In order to print in different colors, one only needs different spools of filament. One downside of this method is that any overhanging structure need a lot of support structure in order to not collapse during the printing process. It is also very difficult to get a flat

surface. On the surface of the parts, there is a stair step design due to the way the part is printed.

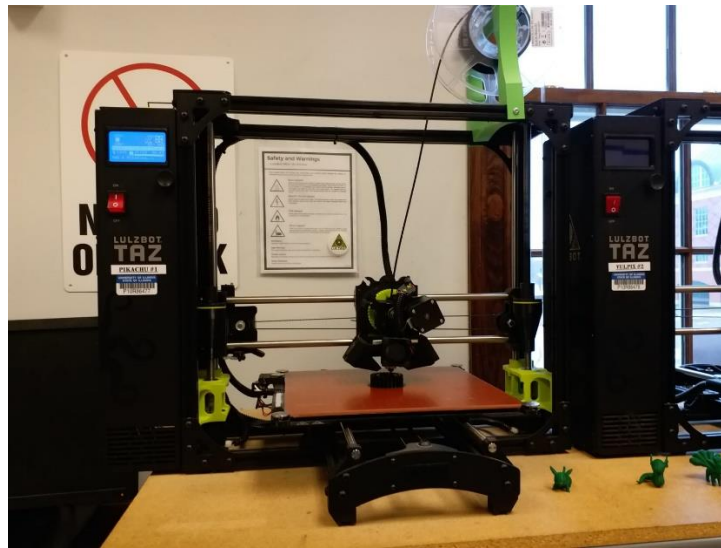

Figure 42, 3D printer

As FDM was the most effective method, a piece in Creo was designed and 3D printed to know if this method was effective enough to use in the project and find the biggest differences between the Creo model and the printed piece.

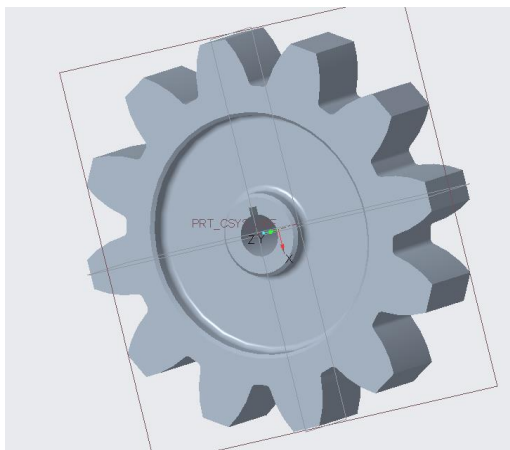

Figure 43, CAD model vs printed part

The Creo model is smoother compared to the final design. On the final model, one can see all the layers created by the 3D printer, while as on the Creo model there is no layers. The dimensions and details of the 3D printed gear, although they are very similar to the Creo model, they are not exactly the same, due to the support material added. This

has to be taken into account when designing a device. However, in overall, this method is accurate and effective enough to be used.

### B. Machining

Machining consists in cutting a raw piece into the desired final shape and size. Figure 44 shows the machine used for this process.



Figure 44, drill machine

This process is widely used to manufacture many metal products. This method was used to see the results and find if it was effective using it. For this reason, the arm of the zipper wheel was made (this part was supposed to be used in the device, however, later it could be seen that it would not work so it is not in the final prototype). One of the constraints to do this process is that the part cannot be overly complex.

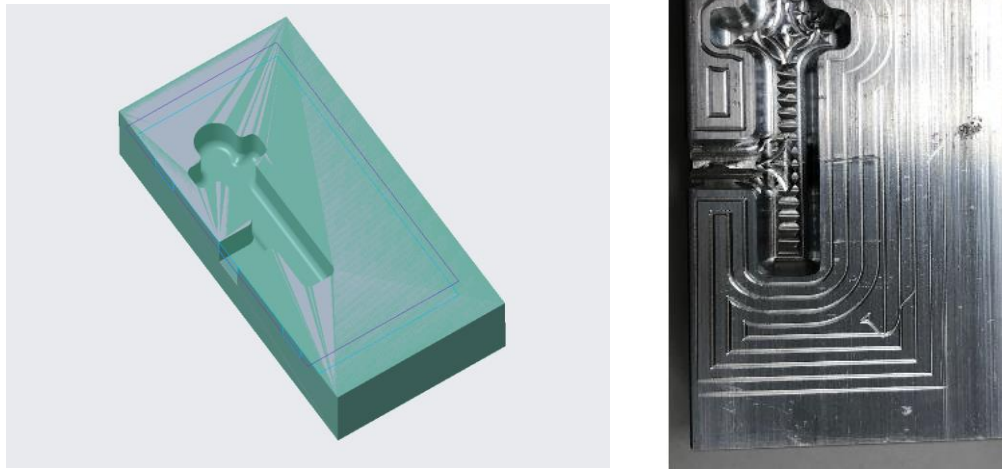

Figure 45, CAD model vs. machined part

The most visible difference between figures is the surface finishing. On the cad model, one can see that the bottom of the part is completely smooth. However, on the machined part one can see that the bottom of the part is very rough. This difference in surface finish is due to how the part was machined. Since the edges were rounded on the cad model, and the part was quite simple, there were not many differences between both. However, after machining the part, one could see that this process was not efficient enough to make a part of this project due to the fact that all these parts must be very small. If a larger part would have to be made, this type of machining would have been a good option.

### C. Injection Molding

This process consists in injecting molten material into a mold at a determined pressure and temperature determined by the user. This mold has been created by machining. Plenty of materials can be used in this process, such as metals, glasses, elastomers. In this process, it is important to consider the shape of the mold, because maybe it is hard to remove the part from the mold. One can predict the characteristic of the part using a software called Moldflow. For example, in this case, a part was molded and obtained the predictions by this software to analyze if it was worthy using it for the parts.

Figure 46 shows the machine used to inject mold a part.



Figure 46, injection molding machine

Figure 47 shows the part that has been injection molded in the lab. This model had three extrusions at the top of the castle but other than that was a fairly simple part. These extrusions however made it a complicated enough part to teach the caveats of injection molding.

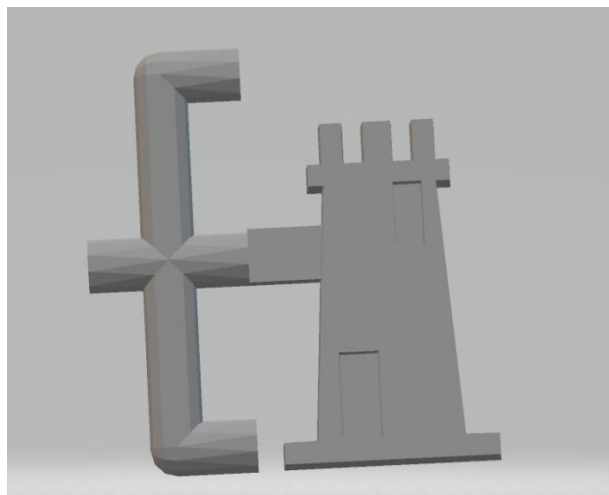

Figure 47, CAD model

One of the problems predicted by Moldflow dealt with the pressure difference between some areas in the part. On Figure 48, one can see that the leftmost top extrusion and the bottommost right corner are predicted to feel much less pressure than the center

of the part. This can be seen through the color difference on the model; the center region of the model is red color which correlates to high pressure whereas some edges of the model are a blue color which correlate to low pressure. This low pressure is caused by the design of the mold. The only channel used to the mold is the middle one, so the outer edges are likely to not receive the pressure the middle edge does. This could have been solved by altering the part geometry or connecting another channel to the part.

However, one can see another issue related to the final part. From Figure 47 and Figure 50, it is clear that the geometry has been compromised during the injection molding process. On Figure 49, the extrusions at the top of the castle were not completely milled into the mold. This occurred because they were too small for the mill used. On Creo, one can make part geometry as small as they want, but when milling into a Cam Block, parts can only be small as the smallest diameter mill. To solve this problem, wider extrusions could have been made so that the mill would properly create the mold. Another solution would have been to scale the whole model.

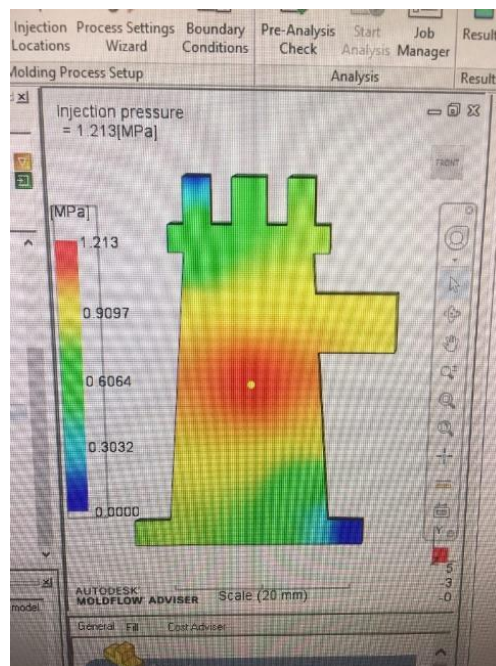

Figure 48, Pressure Prediction





Figure 49, Cam Block Mold



Figure 50, Injection Molded Part

It was recommended to analyse the effect that the pressure and temperature had on the molded part. That is why a more complex part has been used to analyse the effect that these two parameters had on the flow distance. The following spiral, shown in Figure 51, has been used and several trials have been performed, where data has been obtained and different graphs have been plotted:

	31MPa	39MPa	47MPa
436K	260.35mm	342.9mm	444.5mm
450K	292.1mm	384.175mm	444.5mm
464K	323.85mm	438.15mm	393.875mm

Table 11, Data Obtained after Performing Trials



Figure 51, Spiral

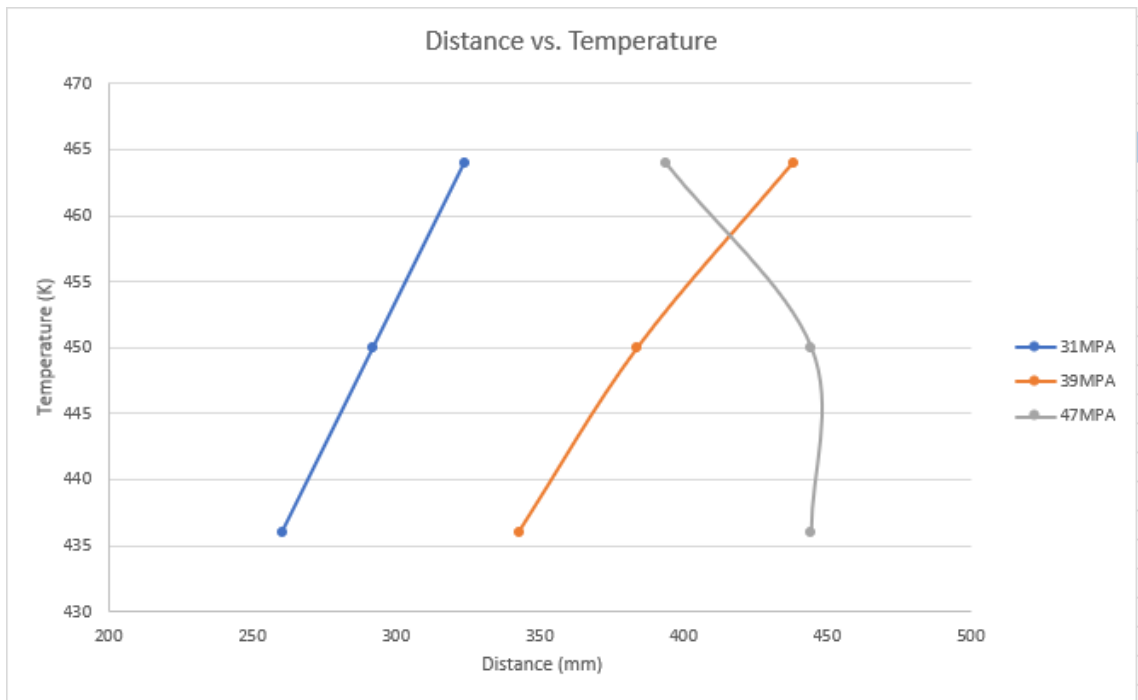

Figure 52, Distance vs. Temperature



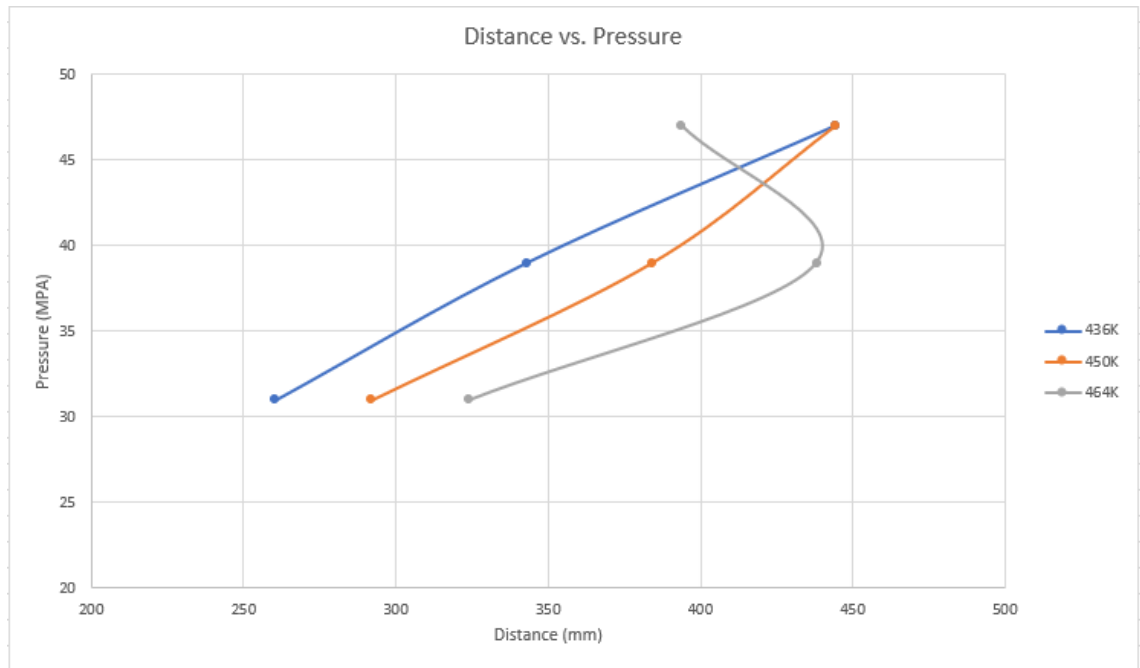

Figure 53, Distance vs. Pressure

Upon looking at the graphs, it is clear that varying the pressure (given a temperature), had a larger effect on the flow distance than varying the temperature.

The high confidence of fill has also been calculated (calculated with Modflow), which means what for sure is going to be filled and compared it with the experimental results. The following table shows the results using 325F:

Pressure (MPa)	Experimental result (in)	High confidence of fill (in)	Difference (%)
31	10.25	6.69	-34.73%
39	13.5	9.05	-32.96%
47	17.5	10.63	-39.25%

Table 12, Percentage Difference Between Experimental Result and High Confidence of Fill

From the table, it can be assumed that Modflow program is very conservative. The prediction results are much lower than the experimental ones, due to the definition of high confidence fill, explained before.

One major thing to be concluded from this technique is that part geometry proves extremely crucial to success. Initially, the CAD design was very important when milling the mold for the part. If one did not account for the diameter of the smallest mill, one could end up with a large discrepancy between mold and CAD design.

However, the initial CAD design was also important when filling the mold with molten plastic. Although this technique proves to be very efficient in many cases, for this project it would not be, because small parts will be used. That is why this technique will not be used for the project.

#### D. Laser Cutting

Laser cutting is another process used in the industrial manufacturing applications. In this process, a laser beam is directed to a material (typically optics), that is burned a cut into the desired shape. A G-code of the shape is what the laser cutting machine will read to create the motion and get the part.

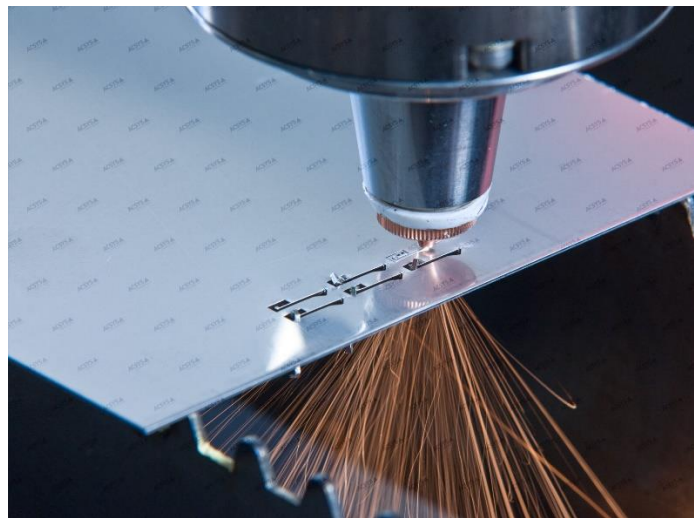

Figure 54, Laser Cutting [Source:

[https://www.bing.com/images/search?view=detailV2&id=CF9D983C59378F37F03C4D2B2802DD5D61E9F038&thid=OIP.TTtTtg57MFBYR10qZ3dTAAHaE0&mediurl=https%3A%2F%2Fwww.acsys.de%2Ffileadmin%2Fpublic%2FImages%2FVerfahren%2FFlaserschneiden%2FFlaserschmelzschnneiden%2Flarge%2Facsys\\_laserschmelzschnneiden\\_1mm\\_edelstahlblech\\_large.jpg&exp=1300&expw=2000&q=laser+cutting&selectedindex=129&ajaxhist=0&vt=0&eim=1,2,6\]](https://www.bing.com/images/search?view=detailV2&id=CF9D983C59378F37F03C4D2B2802DD5D61E9F038&thid=OIP.TTtTtg57MFBYR10qZ3dTAAHaE0&mediurl=https%3A%2F%2Fwww.acsys.de%2Ffileadmin%2Fpublic%2FImages%2FVerfahren%2FFlaserschneiden%2FFlaserschmelzschnneiden%2Flarge%2Facsys_laserschmelzschnneiden_1mm_edelstahlblech_large.jpg&exp=1300&expw=2000&q=laser+cutting&selectedindex=129&ajaxhist=0&vt=0&eim=1,2,6])