



UNIVERSIDAD PONTIFICIA COMILLAS

ESCUELA TÉCNICA SUPERIOR DE INGENIERÍA (ICAI)

OFFICIAL MASTER'S DEGREE IN THE  
ELECTRIC POWER INDUSTRY

Master's Thesis

**LONG-TERM MODELLING OF THE REPUBLIC  
OF SOUTH AFRICA'S NATIONAL ELECTRICITY  
MARKET**

**Author:** Marta Pérez Mérida  
**Supervisor:** Patricia Blanco Fernández  
**Co-Supervisor:** Pablo González Gascón y Marín

**Madrid, July 2019**



## Master's Thesis Presentation Authorization

THE STUDENT:

Marta Pérez Mérida

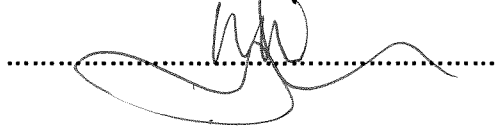

THE SUPERVISOR

Patricia Blanco Fernández

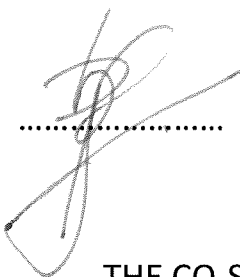
Signed:  Date: 5 / 7 / 2019

THE CO-SUPERVISOR

Pablo González Gascón y Marín

Signed:  Date: 5 / 7 / 2019

Authorization of the Master's Thesis Coordinator

Dr. Luis Olmos Camacho

Signed: ..... Date: ...../ ...../ .....





UNIVERSIDAD PONTIFICIA COMILLAS

ESCUELA TÉCNICA SUPERIOR DE INGENIERÍA (ICAI)

OFFICIAL MASTER'S DEGREE IN THE  
ELECTRIC POWER INDUSTRY

Master's Thesis

**LONG-TERM MODELLING OF THE REPUBLIC  
OF SOUTH AFRICA'S NATIONAL ELECTRICITY  
MARKET**

**Author:** Marta Pérez Mérida  
**Supervisor:** Patricia Blanco Fernández  
**Co-Supervisor:** Pablo González Gascón y Marín

**Madrid, July 2019**



## Abstract

In a highly competitive and increasingly liberalized environment, multinational utilities look for business opportunities across all geographies worldwide. This continuous search of different alternatives is a fundamental step for the utilities to identify potential attractive business which may contribute to their economic growth and international expansion in the long-term.

Long-term models are a powerful tool to support these decisions. To this extent, the optimization model that has been developed in this Thesis forecasts the electricity prices and the evolution of the capacity and generation mix until 2050 in South Africa. The model, which has been developed in-house using GAMS language, falls under the category of long-term capacity expansion model and it minimizes the total cost of expanding the system, taking into consideration both investment and operating costs.

Several scenarios have been simulated with the aim of analyzing the expansion of the system and the evolution of the electricity price, as well as studying the profitability that renewables technologies would get under those conditions.

The base case considers the renewable targets set by the Government of South Africa in its Integrated Resource Plan published last August, 2018 and a medium-demand projection provided in the same document. From this base case, the following scenarios have been proposed: i) High and low demand-projections and same renewable target and ii) medium demand-projections and high renewable penetration scenario. These simulations have been performed considering infinite transmission capacity among South African provinces. Finally, a sensitivity analysis has been developed considering a limited capacity in the transmission lines.

The results show that coal generation, which is the dominant source in South Africa, will reduce almost by half in the long-term in exchange of a larger share of more efficient gas technologies and a strong increase of renewable sources.

Electricity prices are forecasted to rise over the next decade - as gas technologies start to set the price most of the hours within a year- and reach a stable level afterwards, being prices contained by the high renewable penetration in the system.

The profitability analysis of renewable technologies under the different scenarios shows that renewables are likely to become profitable in the market by 2030. However, the appropriate accomplishment of the transmission planning is found to be extremely relevant. The sensitivity analysis shows that renewable technologies may not become profitable if a decoupling among areas occurred, as it would lead to depressed prices in those areas where renewable penetration is higher.

As a conclusion, South Africa could present potential favorable conditions for the deployment of renewable technologies but high attention should be paid to the risk of zonal markets decoupling and potential cannibalization between renewables sources if this was the case.





# CONTENT

Abstract .....	3
Chapter 1. Introduction .....	11
1.1 Preliminary Works .....	11
1.2 Motivation .....	12
1.3 Objectives .....	14
1.4 Structure of this Report .....	14
Chapter 2. South Africa's electricity market .....	15
2.1 General Description .....	15
2.2 Energy Supply in South Africa.....	16
2.2.1 Coal .....	16
2.2.2 Petroleum and Gas .....	18
2.2.3 Renewable Energy .....	20
2.3 Key players in the Electricity sector.....	21
2.4 Structure of the South African power system .....	23
2.4.1 Generation.....	23
2.4.2 Demand .....	23
2.4.3 Renewable Energy Programme .....	25
2.4.4 Transmission and Distribution.....	26
Chapter 3. Proposed Method .....	29
3.1 Model Input .....	29
3.1.1 Fundamentals .....	29
3.1.2 Economic Parameters.....	34
3.1.3 Province Breakdown.....	34
3.1.4 Interconnectors .....	37
3.1.5 Hydro profile.....	40
3.1.6 Hourly Profiles: Renewable and Demand.....	40
3.2 Problem Formulation.....	43
3.3 Model Simulation.....	45
3.4 Output Scan .....	46

Chapter 4. Results.....	49
4.1 Power system expansion analysis.....	49
4.1.1 Technology mix.....	49
4.1.2 Renewable share .....	52
4.1.3 Analysis by province .....	53
4.2 Price evolution .....	56
4.2.1 Price evolution under different scenarios.....	56
4.3 Renewable profitability analysis.....	58
4.3.1 Profitability analysis under different scenarios.....	60
4.4 Sensitivity analysis .....	61
Chapter 5. Conclusions .....	65
References .....	67
<i>Annex A: Input parameters.....</i>	<i>69</i>
<i>Annex B: Evolution of the installed capacity in the period 2019-2050.....</i>	<i>73</i>
<i>Annex C: Evolution of RES income under different scenarios .....</i>	<i>74</i>

## List of Figures

Figure 1. Policy context for energy in South Africa .....	13
Figure 2. Location and provinces map of the Republic of South Africa .....	15
Figure 3. Rate of change of real GDP .....	15
Figure 4. Total primary energy consumption in South Africa (2016).....	16
Figure 5. Coal consumption by industry (2006) .....	17
Figure 6. Primary coal production and consumption in South Africa (2016).....	17
Figure 7. Petroleum and other liquids production and consumption in South Africa (2016).....	18
Figure 8. Key South African gas infrastructure.....	19
Figure 9. Natural gas production and consumption in South Africa (2016) .....	19
Figure 10. Wind resource in South Africa (2019) .....	20
Figure 11. Solar resource in South Africa (2019).....	20
Figure 12. SAPP Southern Africa Development Community Grid Map.....	22
Figure 13. Capacity and generation mix in South Africa (2018).....	23
Figure 14. Evolution of total electricity demand 2002-2018 .....	24
Figure 15. Electricity consumption by economic sector .....	24
Figure 16. Cumulative investment committed (BW4 onwards) and realised (BW1-3.5).....	26
Figure 17. Location of major transmission projects.....	27
Figure 18. Expected Electricity Demand Forecast .....	30
Figure 19. Existing power stations in South Africa .....	32
Figure 20. Historical monthly data of electricity distributed in South Africa.....	34
Figure 21. Historical annual demand by province 2009-2018 .....	35
Figure 22. Historical and average electricity consumption by province .....	35
Figure 23. Provincial peak demand in 2018 .....	36
Figure 24. Existing SAPP interconnections .....	38
Figure 25. Historical monthly profile of South African imports and exports .....	39
Figure 26. Maximum, minimum and average monthly profile of imports and exports (last 10 years) .....	39
Figure 27. Historical electricity exchange by frontier .....	39
Figure 28. Average daily demand profile in South Africa.....	40
Figure 29. Historical series of provincial load factor data.....	41
Figure 30. Description of the objective function of the optimisation model .....	43
Figure 31. Followed methodology scheme .....	47
Figure 32. Capacity expansion outlook 2019-2050 in South Africa .....	49
Figure 33. Generation expansion outlook 2019-2050 in South Africa.....	51
Figure 34. Evolution of the renewable share in South Africa for the period 2020-2050.....	52
Figure 35. Evolution of the renewable share by province in the period 2020-2050 .....	52
Figure 36. Capacity mix evolution by province in 2020-2030-2040-2050.....	53
Figure 37. Average monthly generation profile evolution in Gauteng .....	54

Figure 38. Average monthly generation profile evolution in Eastern Cape.....	55
Figure 39. Price outlook 2019-2050 in South Africa.....	56
Figure 40. Profitability analysis of solar PV .....	58
Figure 41. Profitability analysis of on-shore wind .....	59
Figure 42. Evolution of the generation mix under the sensitivity analysis .....	61
Figure 43. Evolution of spillages under the sensitivity analysis .....	62
Figure 44. Price forecast under the sensitivity analysis .....	63
Figure 45. Renewable technologies profitability under the sensitivity analysis.....	63

## List of Tables

Table 1. Ratio for peak demand calculation based on IRP update 2016 .....	30
Table 2. New technologies costs and performance. ....	32
Table 3. RES capacity targets 2018-2040.....	33
Table 4. Evolution of procured renewable capacity by province.....	36
Table 5. Province interconnection matrix for year 2018 .....	37
Table 6. Transfer limits of international connections of South Africa with neighboring countries.....	38
Table 7. Monthly average load factors by technology and province for the selected data series.....	42
Table 8. Renewable targets under the high RES scenario.....	57
Table 9. LCOE for renewable technologies.....	58



## Chapter 1. Introduction

In this chapter, it will be discussed the motivation of the present Master Thesis, as well as the main objectives of this study. An introduction will be also developed in order to set the basis for the further discussion and procedures developed in the following chapters of this document.

### **1.1 Preliminary Works**

Long-term planning is broadly used to evaluate strategic decisions. This planning implies forecasts and decisions up to 20-30 years. Some of the tasks involved in these studies are the generation expansion planning, the long-term energy prices forecasting, the long-term buying and selling energy contracts management or the long-term fuel buying contracts management.

These planning tasks depend on the responsible agent in charge of them, which are basically the generation companies and the regulatory authorities of the generation business.

In a liberalized framework, generation companies are responsible of the power plant's building and closing down decisions; as well as long-term planning tasks such as risk analysis or valuation and hedging. Although these decisions are responsibility of the companies, the regulatory authorities are still responsible of ensuring the long term supply and the market efficiency. Thus, the main long-term planning tasks of regulatory authorities are the analysis of long-term policies and their influence in the possible sector evolution. A typical function of the regulatory authorities in this framework is the indicative generation expansion planning which can guide companies' decisions.

Mathematical models are therefore a method used by both the companies and the regulatory authorities to carry out the planning tasks efficiently. Mathematical models allow making a simplified representation of the real power systems. Taking some exogenous data as starting point (such as demand or fuel prices), the model carries out some mathematical calculations which allow obtaining values for the endogenous variables of the system. ([DOM108]) Thus, long-term planning helps electric power companies to support decisions regarding optimal allocations of their investments.

To this extent, South Africa's National Development Plan (NDP) 2030 presents a long-term plan for the country. It defines some guidelines to attain a decent standard of living to all South Africans and identifies the critical need for the country to invest in a strong network of energy infrastructure designed to support the country's medium and long-term economic and social objectives. In formulating its vision for the energy sector, the NDP took as starting point the Integrated Resource Plan (IRP) 2010-2030 promulgated in March 2011. The IRP is an electricity infrastructure development long-

term plan based on least-cost supply and demand balance taking into account security of supply and the environment. ([GRSA18])

A large number of generation utilities and regulatory authorities worldwide have used mathematical models in different activities, including the long-term planning of electricity generation. The US Department of Energy developed a long-term analysis model for the different energy activities of the country; SUPER model was used in Central America to carry out the centralized long-term planning of generation capacity and the Balmorel model has been used in Europe to calculate the optimal generation expansion considering in detail the interconnections between the different countries in the Baltic region. ([DOMI08])

Relative to South Africa, the National Renewable Energy Laboratory (NREL) of the U.S. Department of Energy has created a capacity expansion and operational model of the South African power system to investigate least-cost options for renewable energy in the country. This study has been performed under the 21<sup>st</sup> Century Power Partnership (21CPP), which is a multilateral programme of the Clean Energy Ministerial (CEM)<sup>1</sup> and serves as a platform for public-private collaboration to advance integrated policy, regulatory, financial, and technical solutions for the large-scale deployment of renewable energy in combination with deep energy efficiency and smart grid solutions. Its aim is to accelerate the global transformation of power systems. ([CPA19])

## **1.2 Motivation**

In a highly competitive and increasingly liberalized environment, multinational utilities look for business opportunities across all geographies worldwide. This continuous search of different alternatives is a **fundamental step for the utilities to identify potential attractive business** which may contribute to their economic growth and international expansion in the long-term.

To this extent, energy companies willing to study potential investments in the Republic of South Africa may use a long-term model of the electrical market to analyse future electricity prices as well as the development of the generation mix in the country.

The energy sector in South Africa has generally been led by the Government, with national power utility Eskom as monopolist. However, the frequent blackouts that hit the country in 2008 **opened up the industry and saw the rise of Independent Power Producers** ([ESIA18]). The deployment of South Africa's Renewable Energy Independent Power Producer Procurement Programme (REIPPPP), launched in 2011, had led to the country **becoming one of the leading renewable energy investment destinations in the world**. By end June 2015, 1.860 MW capacity had been added to

---

<sup>1</sup> The Clean Energy Ministerial (CEM) is a high-level global forum to promote policies and programs that advance the deployment clean energy technology.



the power system, growing the share of renewable energy from 0% to 4% of the total installed capacity in the country within two-and-a-half years from start of construction ([GRSA17]) .

Within six years, the REIPPPP has attracted total private investment of more than R200 billion: 6 422 MW of electricity have been procured from 112 RE Independent Power Producers (IPPs) in seven bid rounds and 3 876 MW are already connected to the grid. Of the total investment, R48,8 billion (around 24%) originates from foreign investment and financing from a variety of countries across the world, with Europe and United States representing the largest source of finance. The investment flows are concentrated in wind and solar PV technologies. ([GRSA17]) .

As mentioned before, the National Development Plan envisages that South Africa will have in 2030 an energy sector that provides reliable and efficiency energy service at competitive rates where the development of additional electricity capacity is required to meet electricity needs over a 20-year planning horizon ([GRSA18]) . Moreover, the Department of Energy (DoE) was mandated with ensuring security of supply of energy resources and **pursuing an energy mix that includes clean and renewable resources** to meet the needs of the country's fast-growing economy without compromising the commitment to sustainable development ([GRSA15]) .

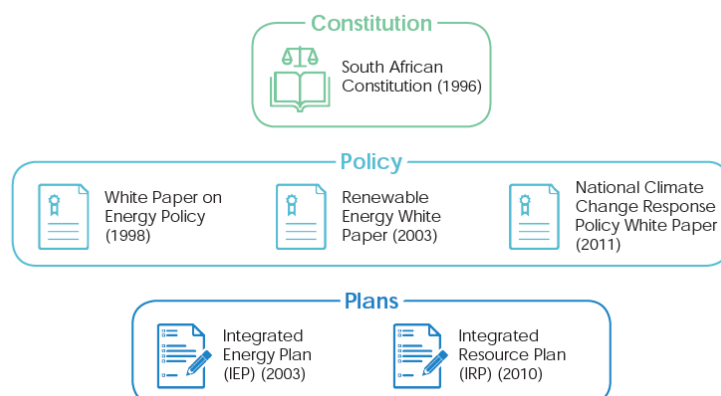

Figure 1. Policy context for energy in South Africa ([GRSA17])

Since the first promulgation of the IRP 2010-2030 in March 2011, some developments have taken place such as,

- Large deployment of renewable technology under the REIPPPP.
- New thermal capacity commissioned
- Some key assumptions for the projections, such as electricity demand forecast –which has resulted in lower demand-, Eskom's existing plant performance or new technology costs.

These changes have motivated a review of the IRP, which was issued last August, 2018.

Under this context, where fundamentals in the long-term have changed, an analysis on the electricity market is needed to study the future development of the system under these new conditions.

### **1.3 Objectives**

The main objective of this Master Thesis is to model the electricity market of South Africa in order to forecast future prices of electricity and estimate the generation expansion in the country in the long term. This information is a powerful support to potential investment decisions.

To this extent, an in-house optimisation model developed in GAMS will be used. The target output of the model consists on the optimal capacity mix and expected production expansion for each technology as well as the forecast of the evolution of the electricity price.

This study is therefore focused on the following objectives:

- Achieving a general knowledge of the South African electricity system.
- Gathering and analysing detailed data about existing and future technologies, historical series of hourly profiles for demand and renewables and other parameters which are needed to model the market. Whenever some data are not available, assumptions will be made based on the best available information.
- Analysing the output of the model to ultimately assess potential profitability opportunities for renewable technologies.

### **1.4 Structure of this Report**

**Chapter 2** of this document provides an introduction and general knowledge about the South African power system.

**Chapter 3** provides a detailed explanation of the methodology that has been followed in the development of this Master Thesis. It also includes a description of the model and of the steps followed during the simulations.

**Chapter 4** provides the analysis and discussion of the results obtained as the output of the model.

**Chapter 5** outlines a set of the main conclusions that can be drawn from this study. Some guidelines for future developments are included.

## Chapter 2. South Africa's electricity market

### 2.1 General Description

The Republic of South Africa is the southernmost African country, bordered by Botswana, Mozambique, Namibia, Swaziland, and Zimbabwe and it surrounds the small Kingdom of Lesotho. It has a population of 57.7 million people (estimate 2018) and a total extension of 1.2 million squares kilometres. South Africa has three capital cities: Pretoria, the country's administrative capital; Cape Town, the legislative capital; and Bloemfontein, the judicial capital; being Johannesburg the largest city. South Africa has eleven official languages, including Zulu and English among others.

The country is divided into nine different provinces, namely, Western Cape, Northern Cape, Eastern Cape, Free State, North West, Gauteng, KwaZulu-Natal, Mpumalanga and Limpopo.

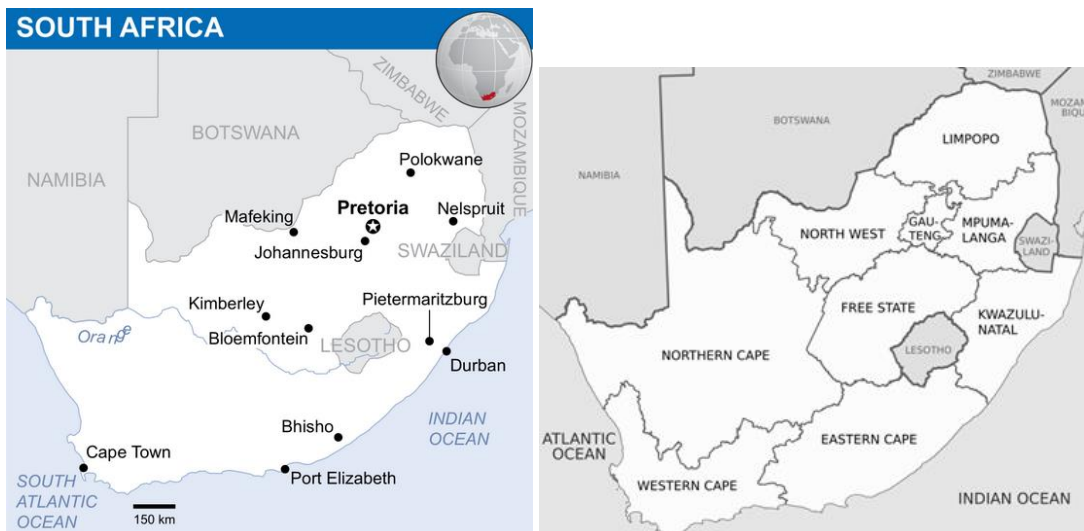

Figure 2. Location and provinces map of the Republic of South Africa

South Africa's economy has grown rapidly since 1994 and the country has become one of the most developed nations in Africa. In terms of gross domestic product (GDP), South Africa is the second-largest economy in Africa and it has the highest energy consumption on the continent (28%). ([EIAD17])

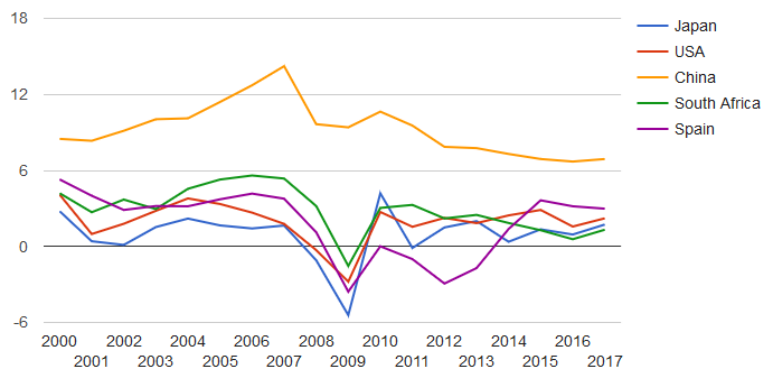

Figure 3. Rate of change of real GDP ([TGEC19])

## 2.2 Energy Supply in South Africa

South African energy supply is dominated by coal with approximately 70% of the primary energy supply followed by crude oil with 22%, natural gas with 4%, nuclear with 4% and renewable with less than 2%. It should be noted that the energy sector is critical to South Africa's economy, as the country relies heavily on its large-scale, energy-intensive coal mining industry.

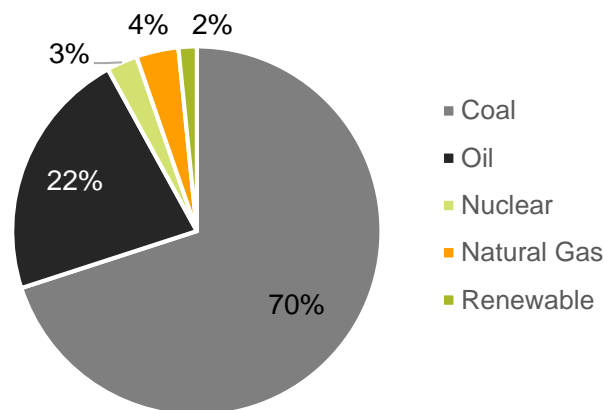

Figure 4. Total primary energy consumption in South Africa (2016 ([EIAD17])

### 2.2.1 Coal

Coal provides over 70% of South Africa's primary energy. Coal in South Africa is different from northern hemisphere coals: It is nearly all bituminous, with very little anthracite; and is generally of low quality with high ash component. However, sulphur levels are low at about 1%.

Coal reserves in South Africa have been proven to account for 1% of total global reserves and for 75% of total African reserves, positioning as the tenth-largest amount of recoverable coal reserves in the world. The bulk of South Africa's coal reserves are situated in the central basin of the country.

Coal production is largely concentrated in the Mpumalanga province, where roughly more than 84% of the country's total coal output is mined. The vast majority of Eskom power plants are located within this province.

Historic data show that around 30% of the total production of coal in South Africa is exported, whereas 70% is sold at national level. Most of these local sales are used for electricity generation and the production of liquid fuels and chemicals. South Africa is a world leader in the use of low quality coal.

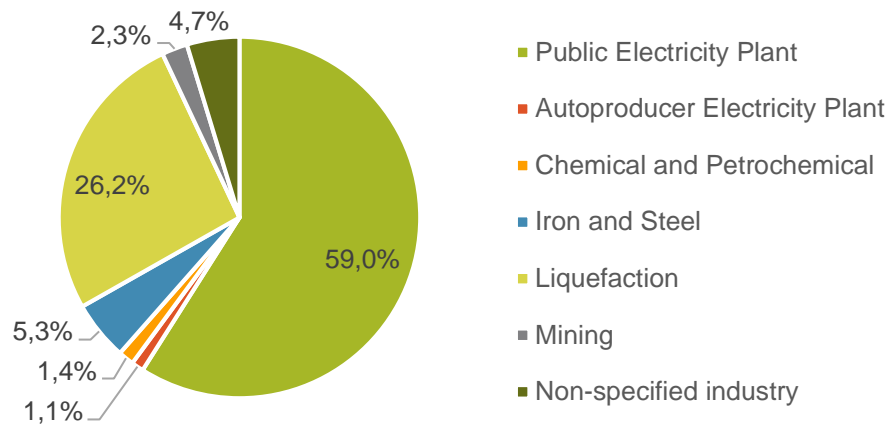

Figure 5. Coal consumption by industry (2006) ([DOER10])

It is worth mentioning that the mining, distribution and sale of coal was deregulated in 1988. However, there is an exception: Some mines are bound to long term contracts with Eskom signed before this date. Therefore, coal prices are considerably lower than those in the rest of the countries of the Organisation for Economic Cooperation and Development (OECD). This provides South Africa with a competitive advantage for exports. ([DOER10])

Around two-thirds of South Africa's coal exports are shipped to Asia, with the largest destination being India. Europe is the second-largest regional importer of South Africa's coal, followed by the rest of Africa, Middle East and America; which positions the country as the fifth-largest global coal exporter. Most of the coal – about 95%– is exported through the Richards Bay Coal Terminal in KwaZulu Natal, one of the world's largest coal export facility. The terminal is connected by rail to the coalfields of Mpumalanga province.

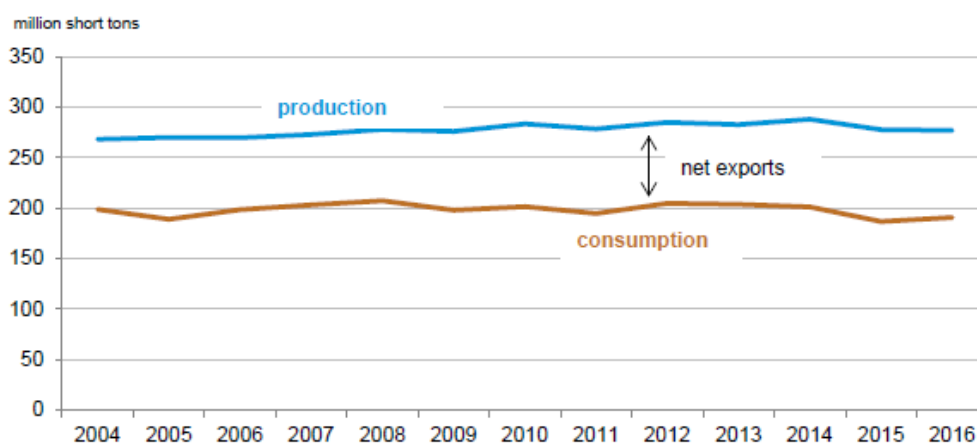

Figure 6. Primary coal production and consumption in South Africa (2016) ([EIAD17])

### 2.2.2 Petroleum and Gas

South Africa has small oil reserves and only modest reserves of gas. All of them are off-shore reserves in fields off the west and south coasts. From political reasons, the South African government started a programme in the 1950s to reduce dependence on crude oil imports, being the idea to make liquid fuels from coal resources. Sasol is the company in charge of producing these synthetic fuels. Originally, it was called the South African Coal, Oil and Gas Corporation and was funded by the Government. It became private in 1979, but at first Sasol still received a tariff protection if crude oil prices dropped below \$16/barrel. This lapsed at the end of 2000.

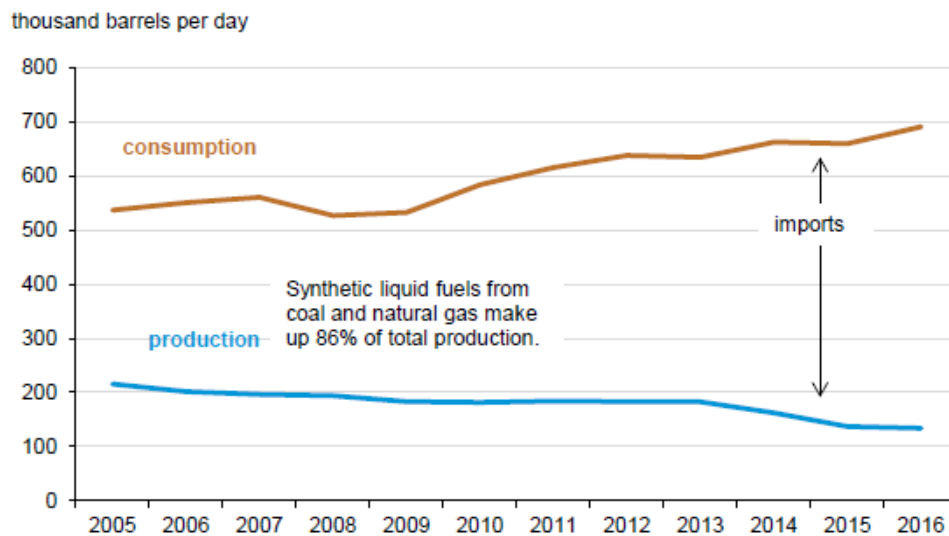

Figure 7. Petroleum and other liquids production and consumption in South Africa (2016) ([EIAD17])

The South Africa gas infrastructure consists of an 865 km high-pressure steel pipeline from Mozambique Temane Pande gas fields to Sasol's Secunda site where it links to the Sasol Gas Network. This network has around 1,500 km pipeline and deliver gas to more than 600 industrial and commercial customers. Apart from this, Sasol supplies Egoli Gas, a distributor supplying piped gas in the metropolitan area of Johannesburg. ([DOER10])

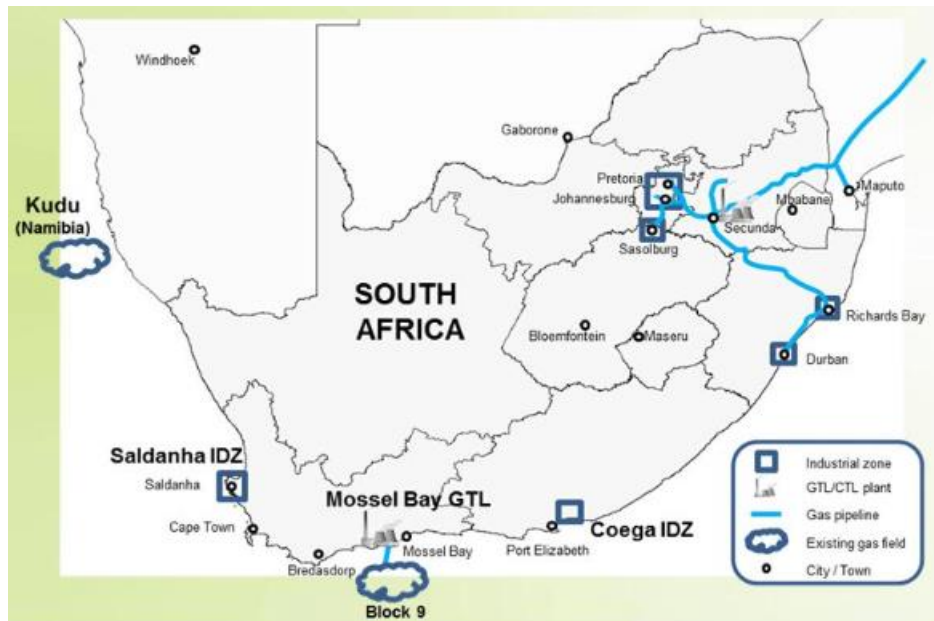

Figure 8. Key South African gas infrastructure ([DOEG10])

Most of the domestic natural gas is produced from the maturing offshore F-A field and South Coast Complex fields and mainly used to supply the GTL facility in Mossel Bay via an offshore pipeline.

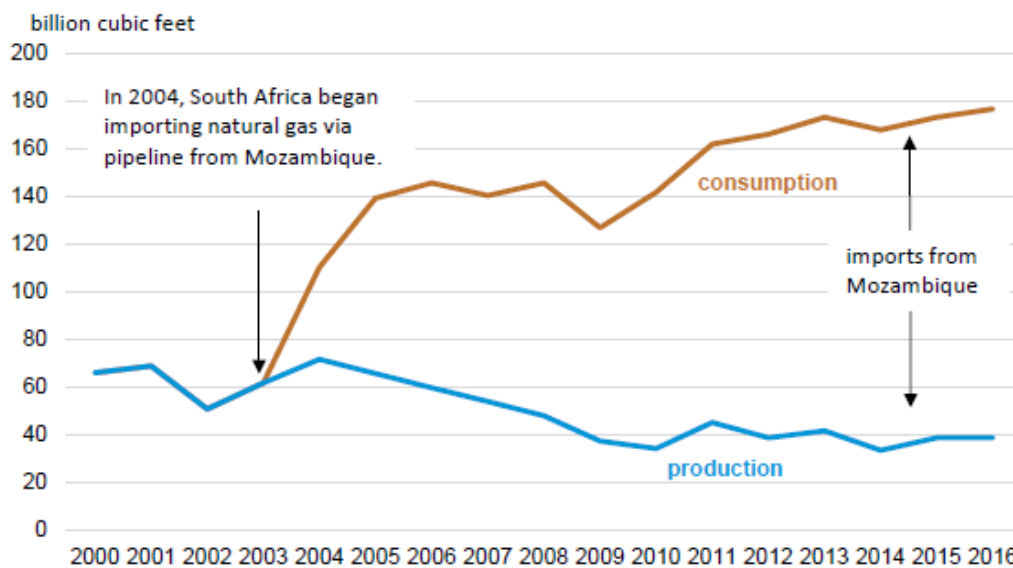

Figure 9. Natural gas production and consumption in South Africa (2016) ([EIAD17])

According to a 2015 study by the U.S. IEA, South-Africa holds the eight-largest technically recoverable shale gas resources in the world (390 trillion cubic feet), mainly located in the Karoo Basin. The government hopes that the shale gas can provide the country with a reliable alternative fuel to coal. However, regulatory uncertainty and environmental concerns have delayed exploration. ([EIAD17])

### 2.2.3 Renewable Energy

South Africa has a large potential to produce energy from biomass, wind, solar and waste. The main use for the renewable energy would be power generation and non-electric technologies such as water heating and bio fuels.

The coastal regions of South Africa have the highest potential for wind generation: Wind projects are largely located along the coastal regions of the Eastern Cape and Western Cape provinces based on the strong wind flows along these shores. Total on-shore wind has an estimated potential to provide 1% out of the total required electricity in South Africa. Wind is used widely for pumping water in remote farms.

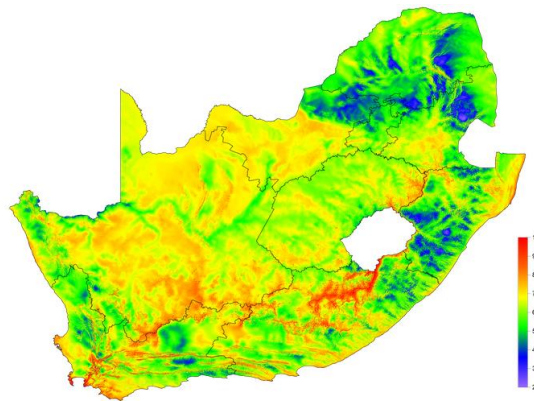

Figure 10. Wind resource in South Africa (2019) ([WASA19])

Hydropower generation is limited in the country because of its environmental impacts, such as flooding of large areas and the displacement of people for constructing the dams.

The solar power potential is very large in South Africa, as it has some of the world's best conditions for its development. Almost the whole of the interior of the country has an average insolation of 5,000 Wh/m<sup>2</sup>/day. The annual 24 hour solar radiation average for South Africa is 220 W/m<sup>2</sup>, compared with 150 W/m<sup>2</sup> for parts of the USA and about 100 W/m<sup>2</sup> for Europe. ([DOER10]) The main applications of solar power are heating, solar cookers, crop drying, heat pumps and electricity generation; being its best applications in the country the heating of water for households and the provision of photovoltaic electricity for remote rural areas.

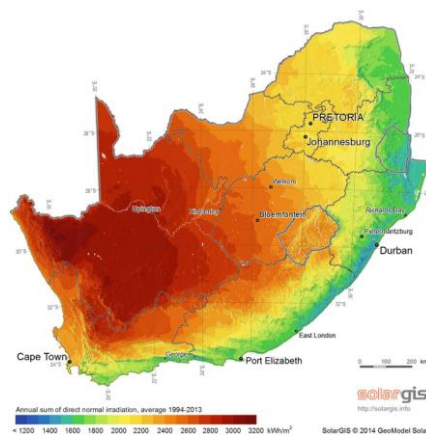

Figure 11. Solar resource in South Africa (2019) ([CRES19])



### **2.3 Key players in the Electricity sector**

The **Department of Energy (DoE)** is the department of the South African government responsible for energy policy. It is in charge of the development, utilization and management of South Africa's energy sources. It formulates energy policies, regulatory frameworks and legislation, and oversees their implementation to ensure energy security, promotion of environmentally-friendly energy carriers and access to affordable and reliable energy for all South Africans. ([DOER19])

The **National Energy Regulator (NERSA)** is the regulatory authority in South Africa for the electricity sector, natural gas pipeline industries and petrol pipe line industries. NERSA regulates electricity prices and is in charge of promoting private sector participation (IPPs) and encouraging off-grid technologies to meet rural energy needs. It also issues generation licenses and enforces their compliance and manages national grid codes.

**Eskom** is the national state-owned electricity utility and generates about 90% of the total electricity demand in South Africa. The remaining 6% is supplied by municipal power stations and self-generation from industries. Eskom also owns and operates the national electricity grid; therefore, it distributes electricity to industrial, mining, commercial, agricultural and residential customers. Eskom was established in 1923 and is the largest of South Africa's state owned enterprises. Last February 2019, the Government announced that Eskom would be split up into three new state-owned entities focusing on generation, transmission and distribution. This decision was taken to address the serious operational and financial problems that the company is facing – poor reliability of supply and large debts. ([ESKM19])

South Africa is a member of the **Southern African Power Pool (SAPP)**, which began in 1996 as the first formal international power pool in Africa, with the aim of providing reliable and economical electricity supply to consumers in SAPP-member countries. The SAPP comprises the utilities of the 12 Member States, namely Angola, Botswana, Democratic Republic of the Congo, Swaziland, Lesotho, Malawi, Mozambique, Namibia, Tanzania, Zambia and Zimbabwe besides South Africa. The SAPP facilitates optional utilization of regional hydro and thermal energy resources, being South Africa the larger exporter and importer in the SAPP.

Eskom exports electricity to Lesotho, Namibia, Botswana, Zimbabwe, Mozambique, Swaziland and Zambia; and imports from Lesotho, Mozambique, Zambia and Zimbabwe.

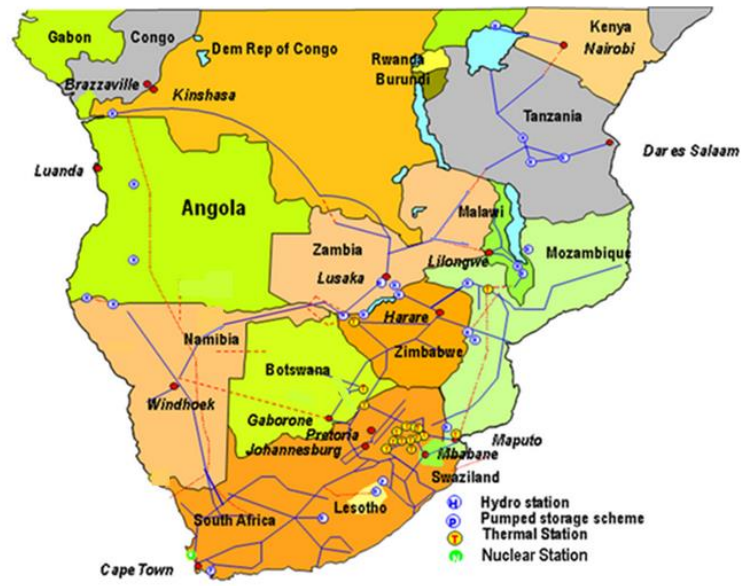

Figure 12. SAPP Southern Africa Development Community Grid Map ([SAPP19])

## 2.4 Structure of the South African power system

### 2.4.1 Generation

South Africa's installed electricity capacity was about 54 GW at the end of 2018. Of this capacity, 72% is coal-fired, 7% petroleum liquids- or natural gas-fired at open-cycle plants, 9% hydroelectric, 3% nuclear, and 8% from non-hydro renewable energy.

Coal is the dominant generation fuel, followed by hydro and fuel-gas sources. Eskom coal-fired plants and the only nuclear power station work as base-load generators. Due to the scarcity of the resource, hydroelectric conventional plants and hydro pumped storage are used when there is a sudden increase or peak in the demand which cannot be met by baseload stations. Besides, gas turbines are quick reaction power stations used only at peak periods and during emergencies due to their very high operating cost, as the run on diesel or kerosene. ([ESKM17])

However, South Africa has struggled with a constrained electricity system over the past decade because the margin between peak demand and available electricity supply was extremely narrow. Reserve margins were low because of aging coal-fired power plants, insufficient investment in power infrastructure, and mismanagement of the sector. Load shedding during peak demand periods occurred frequently between 2013 and 2015, and the lack of electricity security has negatively affected the country's industries and economic growth. ([EIAD17])

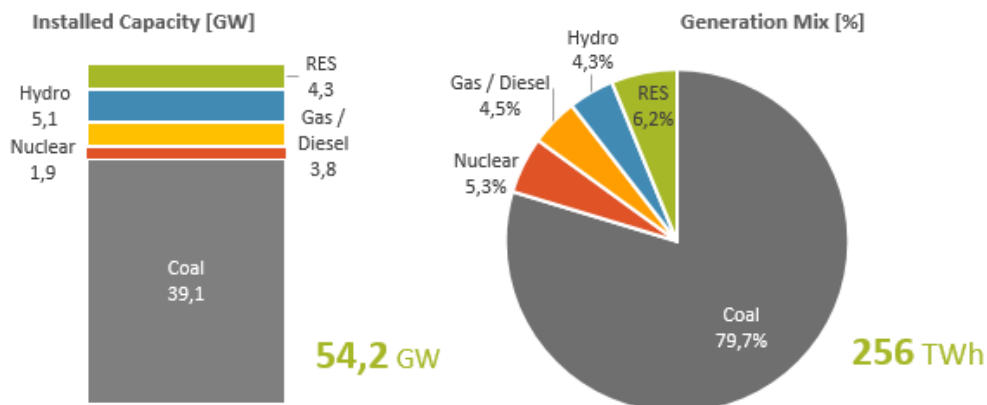

Figure 13. Capacity and generation mix in South Africa (2018) ([GRSA18])

### 2.4.2 Demand

Electricity demand in South Africa has slowed down over the past years at an average rate of -0.6%, mainly due to the slowdown on the economic growth. Some of the underlying causes of the reduced electricity demand are the negative impact that the general economic conditions had in the energy-intensive sectors, the improved energy efficiency, the increasing embedded generation and the fuel switching from electricity to LPG for cooking and heating.

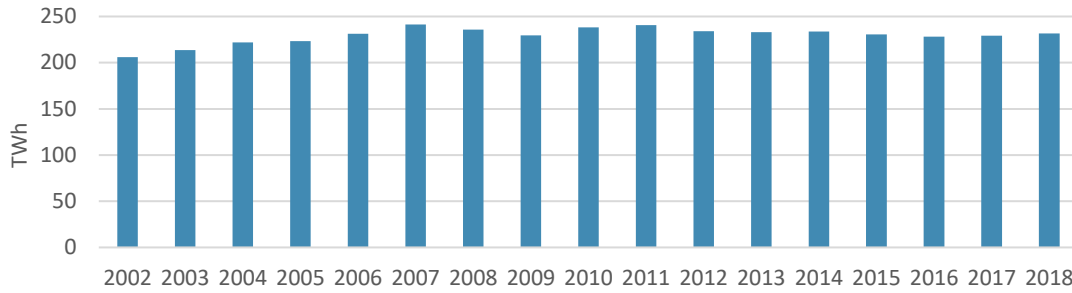

Figure 14. Evolution of total electricity demand 2002-2018 ([STAT19])

The electricity consumption is dominated by the industrial sector which consumes around 60% of all electricity, followed by residential consumption with 20% and commerce and public service with 15%. The remaining is consumed by agriculture and transport.

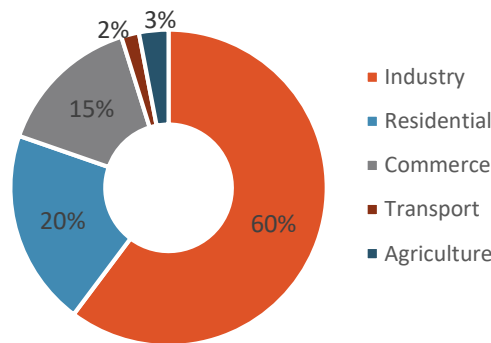

Figure 15. Electricity consumption by economic sector ([DOER10])

**Load shedding** is a frequent practice in South Africa. In order to protect the system from a complete blackout, Eskom uses load shedding and load reduction procedures to effectively manage the power system and protect it from such an event whenever the grid is under pressure with regular measures implemented. As agreed with NERSA, Eskom may implement the following processes in these situations of stress to reduce demand,

- *Load Curtailment*: Eskom's agreement with some of their large industrial customers to instruct them to reduce electricity consumption when it is urgent to balance the system. They are able to reduce their load by up to 20%, significantly easing capacity on the grid; but it takes a minimum of 2 hours to implement.
- *Load shedding*: If, after Load Curtailment, the demand on the system is still greater than available supply, Eskom has to implement a process of load shedding to prevent an imbalance and subsequent blackout. Load shedding will also be implemented if there is insufficient time to request load curtailment; and in winter load shedding can be implemented before curtailment due to the peaky nature of the problem.

Regarding electrification rates, the Integrated National Electrification Programme (INEP) targets to achieve universal access (defined as 97%) by 2025 through grid connection (90%) and Solar Home Systems (7%). In 2013, electrification rates in South Africa were reported to be 90% in urban areas and 77% in rural areas, leading to an overall electrification rate of 85%. ([GETI19])

### **2.4.3 Renewable Energy Programme**

The Department of Energy's (DoE) Renewable Energy Independent Power Producers Procurement Programme (REIPPPP) was established at the end of 2010 as one of the South African government's urgent interventions to enhance South Africa's power generation capacity. The primary mandate of the IPPPP Office is to secure electricity from renewable energy sources from the private sector. The programme is designed to reduce the country's reliance on fossil fuels, stimulate an indigenous renewable energy industry and contribute to socio-economic development and environmentally sustainable growth.

The introduction of private sector generation is contributing to the diversification of both the supply of energy and nature of its production, assisting in the introduction of new skills and in new investment into the industry, and enabling the benchmarking of performance and pricing.

Historically, feed-in-tariffs (FITs) have been the most widely used international government policy instrument for procuring renewable energy capacity. After investigating a Renewable Energy FIT, the South African government favoured a competitive tender approach that has proven to be successful for attracting substantial private sector expertise and investment into grid-connected renewable energy at competitive prices. Tenders are structured as a rolling bid-window programme that allows for market interest and competitive pressure among bidders to participate and offer reduced pricing. The programme has had four phases since its launch. Because of considerable investor interest and the competitive bidding approach, South Africa benefitted significantly from downward technology price trends. The REIPPPP procured energy at increasingly cost competitive rates, with significant price drops between every bid round (from 2,52 R/kWh in the first bid window (BW1) to 0,82 R/kWh in the fourth window (BW4)).

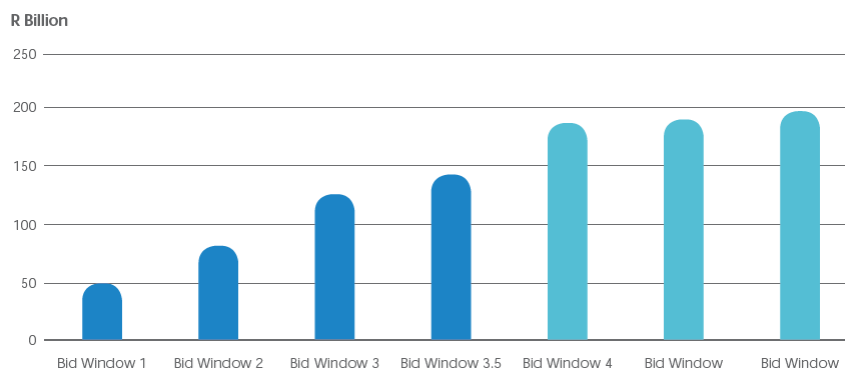

Figure 16. Cumulative investment committed (BW4 onwards) and realised (BW1-3.5) ([GRSA17])

By the end of 2018, the REIPPPP had made the following significant impacts,

- 6 422 MW of electricity had been procured from 112 RE IPPs in seven bid rounds.
- 3 876 MW of electricity generation capacity from 63 IPP projects has been connected to the national grid.
- 32 700 GWh of energy has been generated by renewable energy sources procured under the REIPPPP since the first project became operational.
- Investment of R209.4 billion – of which 20% is foreign investment – had been attracted.
- Carbon emission reductions of 33.2 Mton CO<sub>2</sub>
- Water savings of 39.2 million kilolitres

#### 2.4.4 Transmission and Distribution

South Africa is a large country with an area of 1.2 million squares kilometres, more than 2.3 times the size of Spain. The national electricity transmission grid covers the whole country, from Cape Town to the Zimbabwe border, a distance of over 2,000 km. It has to withstand some severe conditions, such as some of the world's worst lightning conditions in the north eastern region.

Eskom owns, operates and maintains 95% of the national transmission network and shares the distribution network with ~187 licensed municipal distributors. Eskom supplies electricity to more than 6 million customers, whereas municipalities and town councils are in charge of areas where Eskom is not present. Given frequent blackouts in the recent past, partially as a result of aging infrastructure, Eskom has been focusing on the maintenance and refurbishment of the transmission and distribution network, in addition to network strengthening towards the achievement of N-1 Grid-Code compliance and the integration of new generation sources. ([GETI19])

The figure below shows the major existing transmission lines in the country as well as the major projects identified in the Transmission Development Plan published by Eskom for the period 2018-2027.

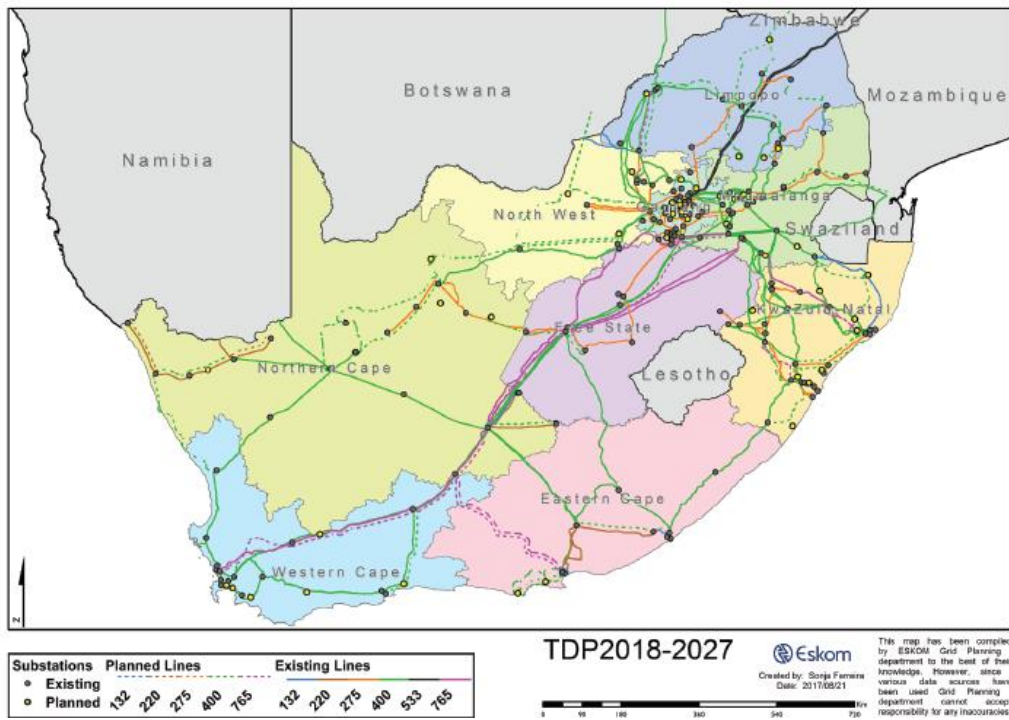

Figure 17. Location of major transmission projects ([ESKT17])





## Chapter 3. Proposed Method

This section presents the methodology followed to model the electricity system of South Africa. The work performed has been divided into three main stages: model input, problem formulation and output analysis.

### 3.1 Model Input

The developed model incorporates a large number of parameters that are needed to model the electricity system. In this stage, this information has been identified, gathered and analyzed. Some assumptions have been made when no information was available. The procedure applied in each case is detailed below.

#### 3.1.1 Fundamentals

This data has been mainly extracted and deducted from the published Draft Integrated Resource Plan (IRP), update 2018; and Eskom publications.

##### *Demand Projections*

The IRP provides a forecast of national power demand for the period 2018-2050. This forecast has been developed using statistical models data-driven and based on historical quantitative patterns and relationships. Different scenarios are provided,

- The **upper forecast** results in an average annual electricity demand growth of 2.0% by 2030 and 1.66% by 2050. This forecast is based on an average 3.18% annual GDP growth and assuming current economic sectoral structure.
- The **median forecast** results in an average annual electricity demand growth of 1.8% by 2030 and 1.4% by 2050; which is based on average 4.26% GDP growth by 2030 and significant change in the structure of the economy, where energy-intensive industries make way for less intensive industries.
- The **lower forecast** results in a 1.21% average annual electricity demand growth by 2030 and 1.24% by 2050, based on a 1.33% GDP growth to 2030. The main assumption in this case is that mining output would continue to grow whereas other sector of the economy would suffer as a result of low investment. This scenario was developed when the country faced possible downgrading decisions by the rating agencies.

The figure below represents the evolution of power demand in the three scenarios described above. Median forecast scenario is considered to develop the base case, whereas lower and upper forecasts are used to perform a sensitivity analysis on the renewable profitability study.

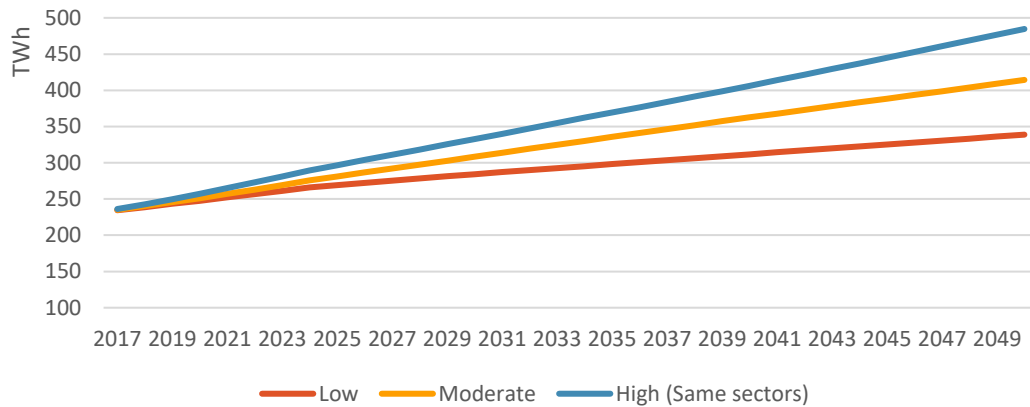

Figure 18. Expected Electricity Demand Forecast ([GRSA18][DOER17])

### Peak Demand

Peak demand update data series have not been published in the August, 2018 submittal of revised IRP. The following assumption has been made when providing the peak demand input into the model: The ratio of annual demand with respect to the peak demand has been calculated based on the last update of IRP in 2016 and is assumed to be the same for the updated projections. ([CSIR17])

Ratio - Peak Demand vs Annual Demand

		2021	1,47	2031	1,36	2041	1,45
		2022	1,47	2032	1,37	2042	1,45
		2023	1,47	2033	1,38	2043	1,45
		2024	1,46	2034	1,39	2044	1,44
		2025	1,47	2035	1,40	2045	1,44
		2026	1,46	2036	1,41	2046	1,44
		2027	1,46	2037	1,42	2047	1,44
		2028	1,46	2038	1,43	2048	1,44
2019	1,47	2029	1,46	2039	1,44	2049	1,44
2020	1,47	2030	1,34	2040	1,45	2050	1,44

Table 1. Ratio for peak demand calculation based on IRP update 2016

These ratios are therefore applied to the demand projections to calculate an updated forecast of peak demand from 2019 to 2050.

### *Technology and fuel costs*

When introducing technology and fuel costs as input parameters in the model, they should be differentiated between existing technology costs and future developments costs.

#### Existing technologies ([ESKP19][ESKH19][ESKG18])

An exhaustive list of conventional existing technologies is done as a first step, identifying the following information:

- Technology source, i.e., coal, nuclear, gas, hydro
- Fuel, i.e., imported coal, national coal, uranium, diesel, natural gas
- Rated capacity (MW) of each group of each power station
- Date of commissioning and expected date of closure / expected end of useful life
- Fuel cost,
  - The gas cost has been calculated based on HH forward prices in the long-term transported to a LNG South African plant. This quotation matches the gas cost identified in the IRP (R135/GW). ([GRSA18])
  - The coal cost has been based on API4 forward prices, as it is a South African reference for coal and is therefore considered as its opportunity cost.
- Efficiency rate
- Forced and planned availability rates
- Emissions rate
- Operation and Maintenance (O&M) costs, both fix and variable
- Province location of each power plant

It should be noted that from the 1970s onwards, the Government of South Africa embarked on a programme of building large, standardized “six-pack” coal stations with a capacity of 3,600 MWe or larger each. Each power station is built next to a coal field and has a coal supplied from the mine by conveyor belts. These plants are the ones located in the Mpumalanga province, therefore it is assumed that these plants have a logistic competitive advantage when compared to the rest of the coal plants in the country, which are not connected to the mines.

Regarding the plant availability of Eskom fleet, it can be highlighted that it has been decreasing since the first promulgation of the IRP. By that time, it was assumed to be 85% and since then it has declined steadily to 71% in the 2015/2016 financial year, recovering to 77,3% in the 2016/2017 financial year. The performance of these plants is foreseen to remain critical for electricity supply planning as Eskom fleet remains the bulk of South African supply mix. A medium plant performance projection is assumed as input to the model, according to IRP assumptions and Eskom Corporate Plan targets.

The next Eskom illustration shows in a schematic way the existing stations in South Africa. A summary table of these input parameters can be found in Annex A.

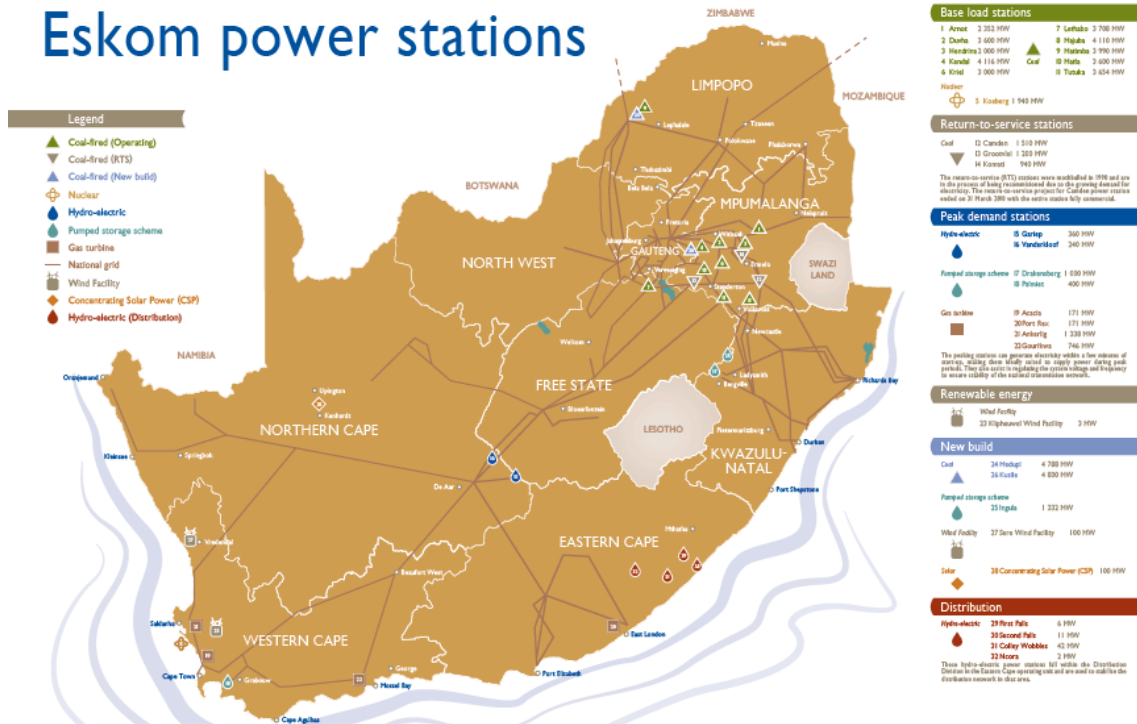

Figure 19. Existing power stations in South Africa ([ESKP19])

### New technologies

The Department of Energy (DoE) engaged the Electric Power Research Institute (EPRI) to provide technology data for new power plants that would be included in the IRP. The EPRI report provides, therefore, updates on the cost and performance of technologies, market-factor influences and additional technology cases based on the January 2017 ZAR/USD exchange rate. It presents the capital costs (overnight cost); operation and maintenance costs (O&M); and performance data. This data can be found in the following table.

	CCGT New	OCGT New	ICE New Internal Combustion Engine	Coal New	Nuclear New
	ZAR 2017	ZAR 2017	ZAR 2017	ZAR 2017	ZAR 2017
Overnight Cost (ZAR/kW)	10131	9226	15427	36983	98079
WACC	8,6%	8,6%	8,6%	8,6%	8,6%
Useful life	30	30	30	30	60
O&M <sub>f</sub> (ZAR/kW/año)	187	181	536	789	933
O&M <sub>v</sub> (ZAR/MWh)	24,7	2,7	135,9	65,9	52,3
Eficiencia (sobre PCS)	49%	31%	41%	37%	35%
<b>Emissions rate</b>					
tCO <sub>2</sub> /MWh	0,302	0,293	0,367	0,9302	0
gSO <sub>2</sub> /kWh	0	0	0	0,00903	0
gNO <sub>x</sub> /kWh	0,00017	0,0003	0,00011	0,00191	0

Table 2. New technologies costs and performance.

### *Renewable targets*

The renewable capacity is set as a parameter input to the model based on the renewable targets considered in the IRP for the period 2018-2050. An average load factor is also provided in the Plan for each technology; which is also set as an input to provide the model with a target annual renewable production.

It should be noted that capacity evolution is provided annually until 2030. From this year on, IRP estimations are provided for 10 years' periods, i.e., 2040 and 2050. It is assumed that the capacity is installed linearly within the ten years' windows. These estimations are represented in grey in the table below.

	Wind	Solar PV	Hidro	CSP	Biomass
2016	0,7	1,1	2,2	0,1	0,5
2017	1,4	1,2	2,2	0,3	0,5
2018	2,0	1,5	2,2	0,3	0,5
2019	2,2	1,5	2,2	0,6	0,5
2020	2,5	1,6	2,2	0,6	0,5
2021	3,3	1,9	2,2	0,6	0,5
2022	3,3	2,3	2,2	0,6	0,5
2023	3,3	2,3	2,2	0,6	0,5
2024	3,3	2,3	2,2	0,6	0,5
2025	3,5	3,0	2,2	0,6	0,5
2026	5,0	4,0	2,2	0,6	0,5
2027	6,6	5,0	2,2	0,6	0,5
2028	8,2	6,0	2,2	0,6	0,5
2029	9,8	7,0	2,2	0,6	0,5
2030	11,4	8,0	4,7	0,6	0,5
2031	13,0	9,0	4,7	0,6	0,5
2032	14,6	10,0	4,7	0,6	0,5
2033	16,2	11,0	4,7	0,6	0,5
2034	17,8	12,0	4,7	0,6	0,5
2035	19,4	13,0	4,7	0,6	0,5
2036	20,9	14,0	4,7	0,6	0,5
2037	22,5	15,0	4,7	0,6	0,5
2038	24,1	16,0	4,7	0,6	0,5
2039	25,7	17,0	4,7	0,6	0,5
2040	27,3	18,0	4,7	0,6	0,5
2041	27,9	18,9	4,7	0,6	0,5
2042	28,5	19,7	4,7	0,6	0,5
2043	29,2	20,6	4,7	0,6	0,5
2044	29,8	21,4	4,7	0,6	0,5
2045	30,4	22,2	4,7	0,6	0,5
2046	31,1	23,1	4,7	0,6	0,5
2047	31,7	23,9	4,7	0,6	0,5
2048	32,3	24,8	4,7	0,6	0,5
2049	33,0	25,6	4,7	0,6	0,5
2050	33,6	26,4	4,7	0,6	0,5

Table 3. RES capacity targets 2018-2040 ([GRSA18])

### 3.1.2 Economic Parameters

The following assumptions are applied for economic parameters,

- Discount rate of 8.2%, according to the calculations of National Treasury included in the IRP;
- Exchange rate as at the beginning of January 2017 (R14.39 to USD; USD to EUR1.14).

### 3.1.3 Province Breakdown

The IRP, as mentioned before, provides information at national level. However, the model developed in this study is provided with provincial information with the aim of analyzing distributional differences within the country.

Some calculations have been performed to distribute the national estimations developed in the sections above among the different nine provinces.

- *Regarding demand consumption*

Based on historical data provided by the Department of Statistics of the Government of South Africa, a historical data base is elaborated for the electricity distributed within the different provinces from years 2002 to 2018.

The figure below represents the monthly profile of the total electricity distributed in South Africa. It can be observed that demand is higher during the central months of the year -June to August-. This profile is available for each province in the database elaborated to feed the model.

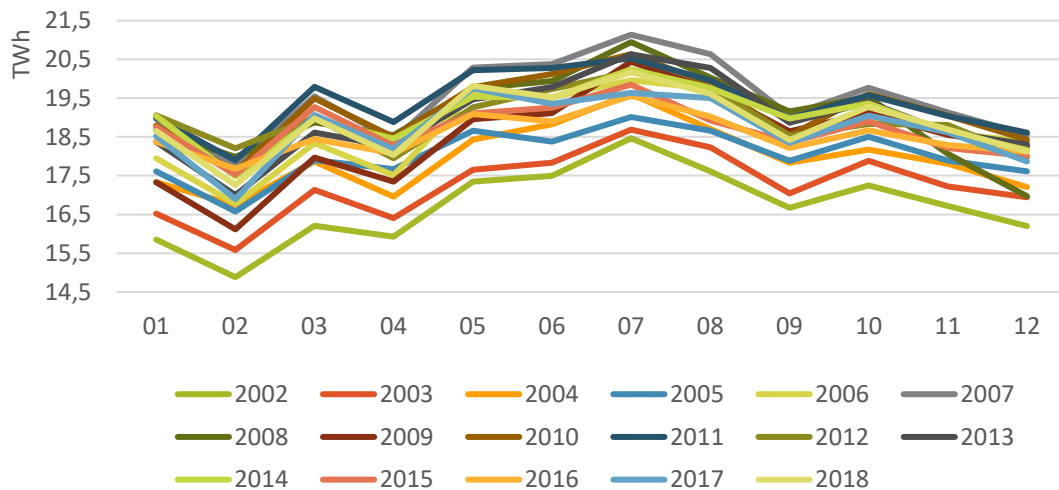

Figure 20. Historical monthly data of electricity distributed in South Africa ([STAT19])

From the gathered data, it can be observed that electricity demand is significantly different among provinces. The analysis for the last ten years is represented in the figure below, where historical data of annual electricity distributed is shown for each province.

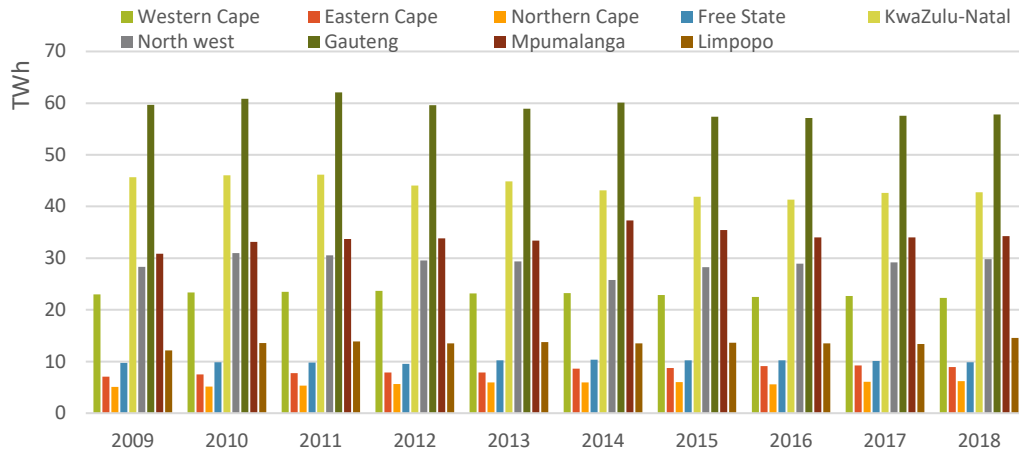

Figure 21. Historical annual demand by province 2009-2018

Gauteng, KwaZulu-Natal and Mpumalanga are the provinces with the highest electricity consumption. In order to forecast the demand projection for each province until 2050, the average weight over the past ten years out of the national total -shown in the figure below- is assumed as constant and applied to the national projections. This assumption is based on the fact that the provincial weight has remained almost constant since the beginning of the historical series.

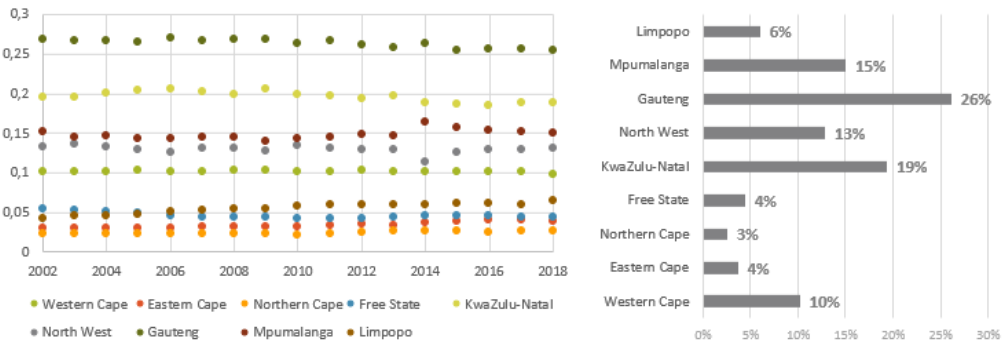

Figure 22. Historical and average electricity consumption by province

- **Regarding peak demand**

Annual provincial peak demand is published on the annual Eskom's report "Multi-Year Price Determination for Revenue application". ([ESKR]) Therefore, the methodology applied to calculate the provincial peak demand forecast is the same as explained in the section above (*demand consumption*): The weight of peak demand of each province out of the national peak demand is calculated from Eskom publications and is assumed to remain constant.

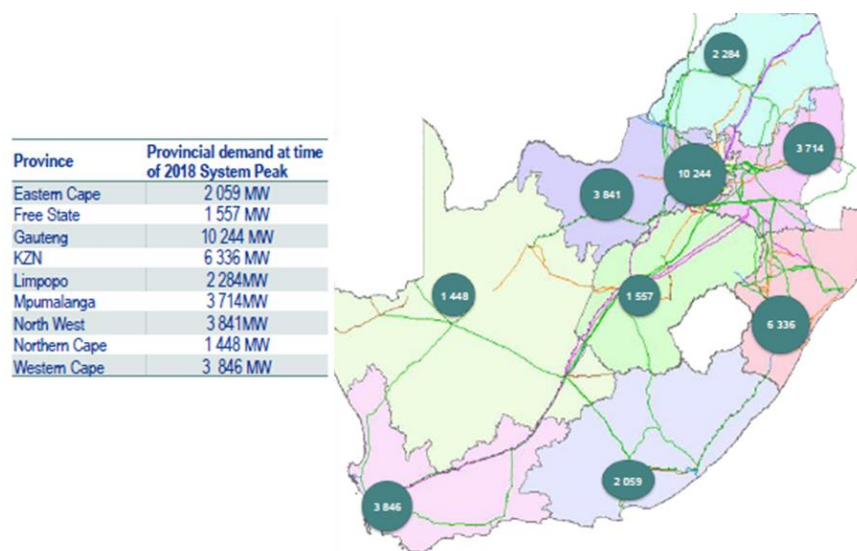

Figure 23. Provincial peak demand in 2018 ([ESKR])

■ *Regarding renewable targets*

The quarterly reports published by the Department of Energy to provide an overview of the activities of the IPPPP Office inform about the provincial evolution of contracted renewable capacity. This information has been gathered with the aim of studying the procured renewable capacity trend in each province. A summary table of this analysis for the last three reports is shown below,

MW	Gauteng	KwaZulu-Natal	Limpopo	Mpumalanga	North West	Free State	Northern Cape	Eastern Cape	Western Cape
<b>WIND</b>									
Dec 2017	-	-	-	-	-	-	1459	1440	467
Jun 2017	-	-	-	-	-	-	1459	1440	467
Mar 2017	-	-	-	-	-	-	1459	1440	467
% by province							43%	43%	14%
<b>PV</b>									
Dec 2017	-	-	118	-	280	219	1552	70	134
Jun 2017	-	-	118	-	280	219	1552	70	134
Mar 2017	-	-	118	-	280	219	1552	70	134
% by province			5%		12%	9%	65%	3%	6%
<b>CSP</b>									
Dec 2017	-	-	-	-	-	-	600	-	-
Jun 2017	-	-	-	-	-	-	600	-	-
Mar 2017	-	-	-	-	-	-	600	-	-
% by province							100%	0%	0%
<b>BIO</b>									
Dec 2017	13	17		30					5
% by province	20%	26%	0%	46%	0%	0%	0%	0%	8%
<b>MINI-HYDRO</b>									
Dec 2017						9	10		
% by province	0%	0%	0%	0%	0%	47%	53%	0%	0%

Table 4. Evolution of procured renewable capacity by province (own elaboration)



In order to project the renewable targets by province, it is assumed a proportional expansion based on the current distributional renewable capacity allocations of the historical auctions of the REIPPPP, represented in the row “% by province” of the table above.

### 3.1.4 Interconnectors

When modelling the interconnectors, two distinctions may be taken into account,

- Regarding provinces
- Regarding international connections

In the case of the connection among provinces, a number of matrixes are introduced into the model specifying which provinces is a specific area connected to. These matrixes are set for every year simulated in the model, this is, every year until 2050. Some assumptions have been made when building the matrixes: First, no limits are imposed to the interconnection capacity among provinces; and second, this unlimited capacity is assumed to be the same in both directions. It is considered that there would not be congestions in the interconnection among provinces, based on the Eskom's transmission plans which consider several projects for the reinforcement of the main corridors throughout the country. ([ESKT17])

The matrix below shows an example of connections between provinces for the year 2018.

	MPU	FST	LIM	WEC	EAC	NWE	GAU	KZN	NOC
MPU		1	1				1	1	
FST						1	1		1
LIM						1	1		
WEC									1
EAC									1
NWE							1		
GAU									
KZN									
NOC									

Table 5. Province interconnection matrix for year 2018 (own elaboration)

For international connections, some more data is needed as these international areas are not modelled in detail as in the case of provinces. Therefore, the first step is to identify the countries South Africa is connected to; second, define the minimum, maximum and firm capacity of each interconnection and third, study the historical direction of the flow.

The data needed for the first two steps can be consulted in the Southern African Power Pool (SAPP) reports.

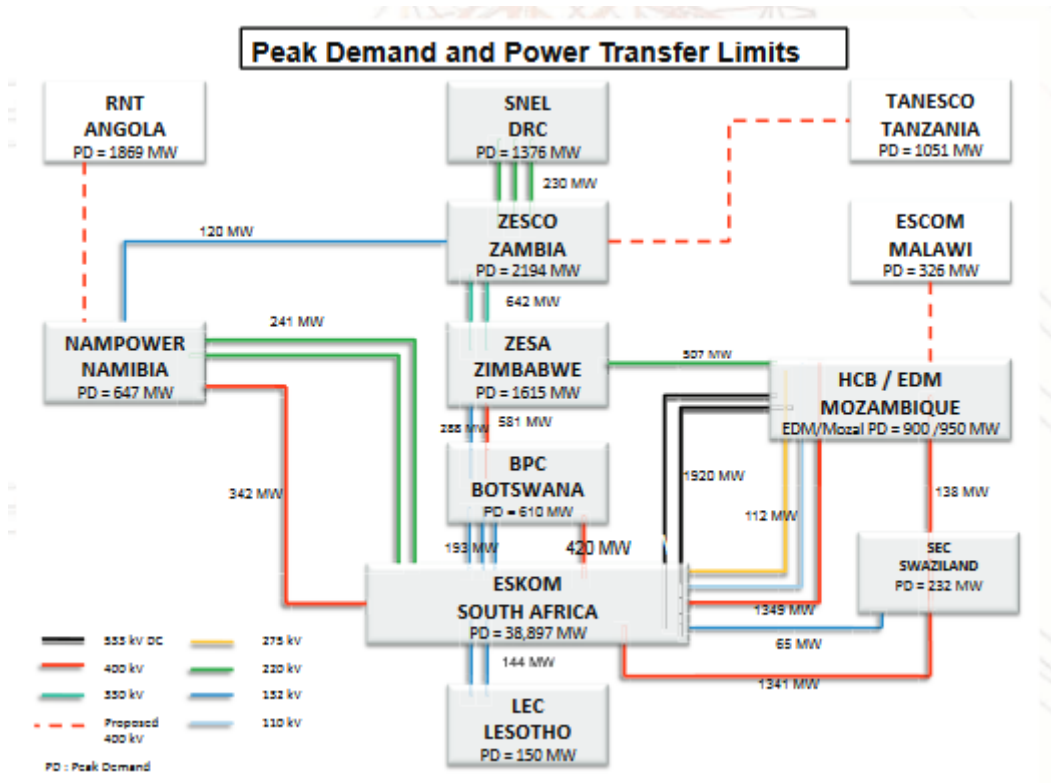

Figure 24. Existing SAPP interconnections ([SAPP18])

As it can be seen in the figure, South Africa is connected with Namibia, Lesotho, Swaziland, Botswana and Mozambique. The technical limits for each interconnection are represented in the table below,

Utility (From - To)	Interconnection (From - To)	Voltage (kV)	Number of lines	Thermal Limit (MW)	Voltage Limit (MW)	Applicable Transfer Limit (MW)
BPC - ESKOM	Spitskop-Gaborone South	132	3	300	270	245
BPC - ESKOM	Derderport - Dwaalboom	132	1	115	75	70
BPC - ESKOM	Gaborone-Spitskop	132	3	115	120	110
BPC - ESKOM	Phokoje - Matimba	400	1	650	200	190
ESKOM -EDM_S	Komatipoort-Corumana	110	1	75	70	67
ESKOM -EDM_S ( MOTRACO)	Arnot-Maputo	400	1	1300	1200	1100
ESKOM -NAM	Aggeneis-Kokerboom	220	2	500	225	195
ESKOM -NAM	Aries - Kokerboom	400	1	630	410	380
ESKOM -SEC (MOTRACO)	Camden - Edwaleni	400	1	1300	1200	1100
ESKOM-LEC	Tweespruit-Maseru	132	2	140	100	90
ESKOM-SEC	Normandie-Nhlangano	132	1	100	80	76
HCB-ESKOM	Songo-Apollo	533	1	750	750	700
ZESA - ESKOM	Beitbridge-Messina	132	1	70	20	15

Table 6. Transfer limits of international connections of South Africa with neighboring countries ([SAPP19])

As mentioned before, these countries are not detailed modeled in this study; therefore, it is assumed a unique flow direction with each area. With the aim of determining the direction of these flows, some analysis of historical data are performed.

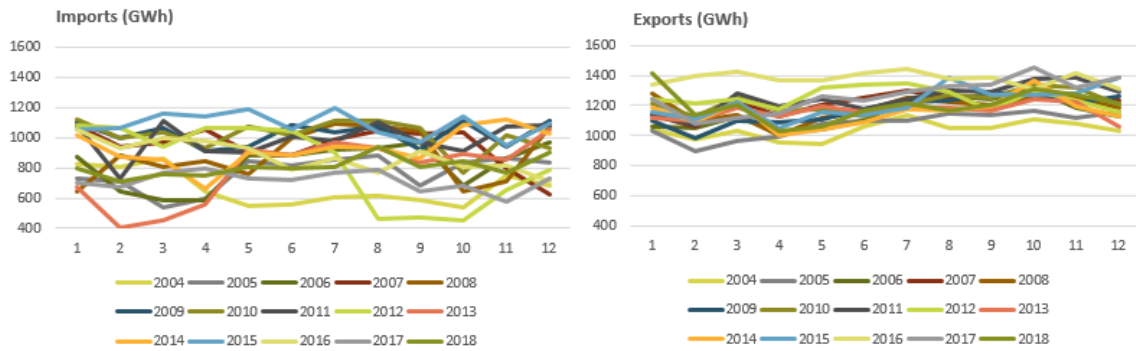

Figure 25. Historical monthly profile of South African imports and exports ([STAT19])

Based on these data, it is calculated a maximum, minimum and average profile for the last 10 years because the first years of the historical data cannot be considered average years as there were less interconnectors in place.

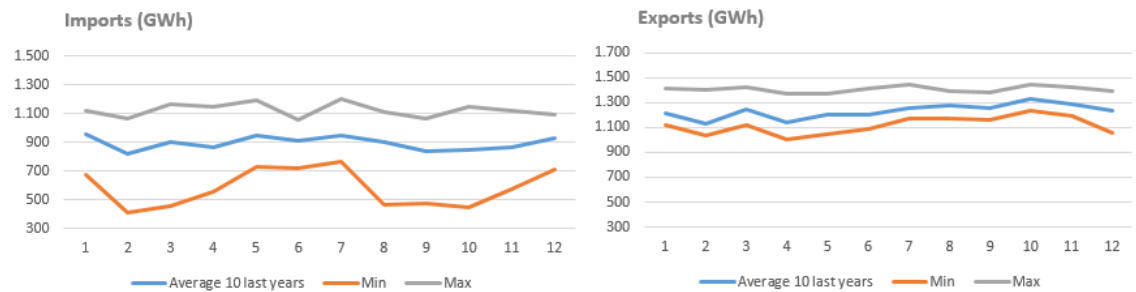

Figure 26. Maximum, minimum and average monthly profile of imports and exports (last 10 years)

These monthly profiles are translated into MW and are later scaled proportionally to the applicable transfer limit of each interconnection to provide the mode with a monthly profile for each frontier.

Finally, the historical net exchanges are observed to determine the predominant direction of each interconnector. As it can be observed in the figure below, it is assumed that South Africa exports to all countries it is connected to but Mozambique, which has large hydro installations close to the frontier with South Africa.

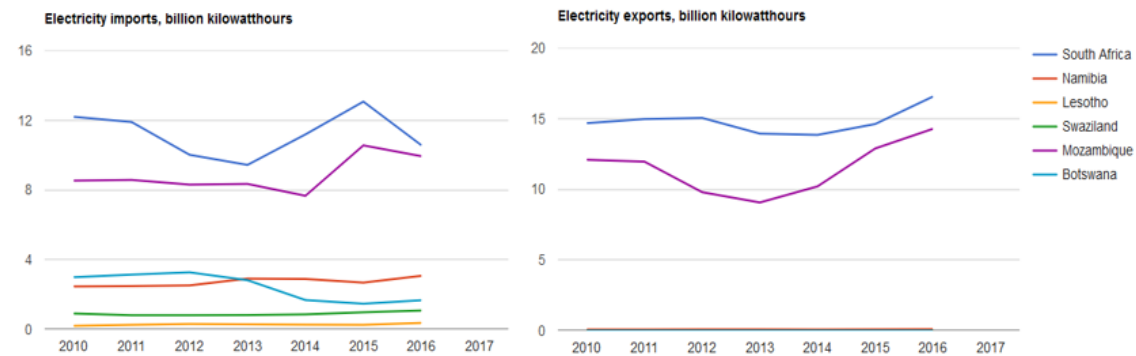

Figure 27. Historical electricity exchange by frontier ([TGEC19])

### 3.1.5 Hydro profile

To model hydro conditions, two different profiles are introduced,

- *Monthly profile:* Maximum and minimum monthly production and capacity parameters are set based on historical data.
- *Annual profile:* Same information is included annually, based on the hydro profile included in the IRP. ([GRSA18])

It should be noted that historical annual hydro production in South Africa is relatively constant, around 16 TWh / year. Water in South Africa is a scarce resource; therefore, its management has developed into a science to ensure that it is used to its full potential and to this end, partnerships have been developed between Eskom and the Department of Water Affairs. ([ESKW17]) The largest hydro stations are located in the province of KwaZulu-Natal, near the limit with Free State.

### 3.1.6 Hourly Profiles: Renewable and Demand

These hourly profiles are provided to the model with the aim of obtaining a detailed output that takes into account the variability of demand and renewable sources during different hours of the day, months and seasons.

Hourly demand profile has been obtained from the CSIR energy centre. The Council for Scientific and Industrial Research (CSIR) is a leading scientific and technology research organisation that researches, develops, localises and diffuses technologies to accelerate socioeconomic prosperity in South Africa. ([CSIR19])

The series contains historical series from years 2015 to 2017. The hourly profile is observed to be similar in the three series; therefore, the most recent series, i.e., that for 2017, is considered as a reference in the model. This data is scaled for each province based on each provincial monthly weight on the total demand of every month (*see province breakdown section for further detail on monthly provincial electricity demand*). To provide an example of the hourly profile, the figure below illustrates the average shape of daily demand in South Africa. Peak demand generally occurs between 6.00-8.00h in the mornings and 17.00-20.00h in the evenings.

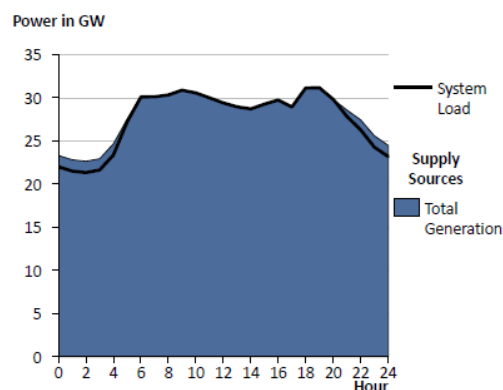

Figure 28. Average daily demand profile in South Africa ([ESKR])

Regarding renewables, the historical data for each technology and province has been downloaded from the database for renewables of the Department of Energy. An example for Western Cape is provided below.

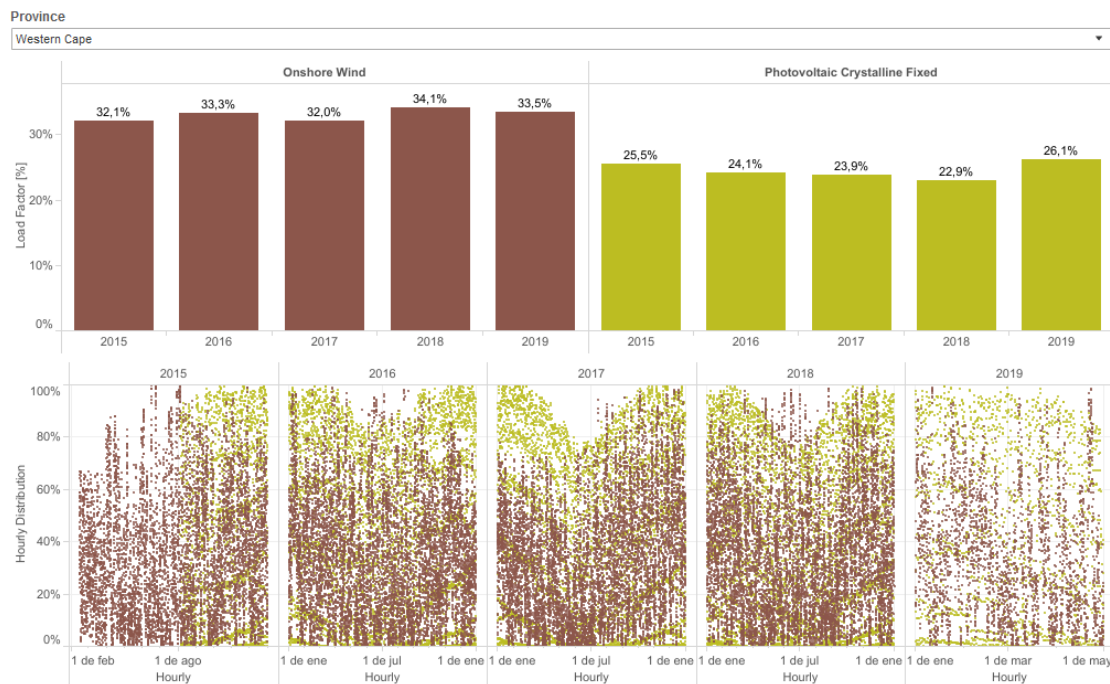

Figure 29. Historical series of provincial load factor data ([DOED19])

Once the data for all technologies and provinces have been gathered in a unique data base, the hourly series have been analysed. The reference series provided to the model are those of year 2017 because these series are the most complete ones: They are available for all provinces, all technologies and have the least values missing. Whenever an hourly value was missed, the average of the adjacent hours was computed to complete the series. Apart from this, the 2017 hourly series are coherent with the data series considered for demand.

The table below shows the summary of the treated data series that have been set as input parameters into the model. The calculated monthly average load factor was compared to the national data published by CSIR on its “Statistics of utility-scale solar PV, wind and Concentrating Solar Power “CSP” in South Africa in 2018” ([CSIS19]) with the aim of checking the coherence of the data series obtained. It can be observed that the values are within the same order range.

Wind												
	Jan	Feb	Mar	Apr	May	Jun	Jul	Aug	Sep	Oct	Nov	Dec
<i>CSIR Reference</i>	39%	36%	31%	29%	31%	37%	38%	33%	35%	40%	41%	46%
<b>Data Series</b>												
WEC	43%	39%	32%	30%	30%	33%	32%	26%	30%	44%	44%	31%
NOC	45%	39%	37%	28%	33%	35%	47%	37%	37%	44%	43%	46%
EAC	35%	36%	29%	31%	32%	42%	36%	36%	38%	37%	39%	34%
Total Avg.	41%	38%	33%	30%	32%	37%	38%	33%	35%	42%	42%	37%

Solar PV												
	Jan	Feb	Mar	Apr	May	Jun	Jul	Aug	Sep	Oct	Nov	Dec
<i>CSIR Reference</i>	30%	27%	26%	22%	22%	21%	20%	24%	25%	28%	30%	30%
<b>Data Series</b>												
WEC	29%	29%	25%	23%	15%	14%	17%	19%	21%	27%	29%	28%
NOC	27%	26%	25%	22%	23%	22%	21%	24%	25%	26%	28%	28%
Total Avg.	28%	27%	25%	22%	19%	18%	19%	22%	23%	26%	28%	28%

CSP												
	Jan	Feb	Mar	Apr	May	Jun	Jul	Aug	Sep	Oct	Nov	Dec
<i>CSIR Reference</i>	53%	47%	26%	36%	30%	25%	21%	30%	41%	45%	55%	47%
<b>Data Series</b>												
NOC	51%	46%	34%	39%	34%	29%	24%	34%	45%	47%	53%	53%

Table 7. Monthly average load factors by technology and province for the selected data series (own elaboration)

### 3.2 Problem Formulation

The model used in this study is an **optimization model for long-term capacity expansion**. It has been developed in-house by Iberdrola and it is named MAIO, for its acronym of *Modelo de Análisis de Inversión Óptima (MAIO)*. The mathematical formulation is done through **linear programming in GAMS language**.

The objective function of this model is to **minimize the total costs** of expanding and operating the system and obtain, as a result, the optimal investments and forecast of generation mix and electricity prices.

$$\min_{q_{ktbs}, nse_{tbs}, p_{kts}} \sum_t \frac{1}{(1+r)^t} \left[ \sum_{kts} (cinv_{kts} \cdot p_{kts}) + \sum_b (cop_{kts} \cdot q_{ktbs}) + cnse_{ts} \cdot nse_{tbs} \right]$$

Discount Rate
Investment cost
Production cost
NSE cost

Figure 30. Description of the objective function of the optimisation model

This objective function is subject to a large number of constraints on investments, operation and environmental. Some important considerations are described below,

- **Reliability** of the system is constrained using the reserve margin as a deterministic index. In this study, 10% has been considered for all provinces.
- Based on the hydro data described in section “3.2 – Hydro profile” of this document, hydroelectric stations are considered as a **generator and equivalent reservoir**. The model will allocate the hydro production in the most expensive hours.
- Technical constraints for the short-term, such as ramps or minimum stable load are **not considered**.
- As stated before, the model is provided with hourly series to consider **chronological detail**. However, due to computational limitations, blocks of two hours are considered instead of single hourly blocks.
- The **energy balance equation** forces equilibrium between generation and demand every hourly block, every month and each province, reaching a total of 1 008 equations for each year [(7 days x 24 hours)/2 x 12 months]. The dual variable associated to this constraint provides the energy price (ZAR/MWh).

$$\sum_{ktb} (q_{ktb}) + nse_{tb} = D_{tb} \forall s$$

- The **capacity balance equation** forces that the reserve margin is satisfied for each year, i.e., there must be enough firm capacity installed to cover the peak demand plus the reserve margin. Different technologies contribute to this firm capacity based on a de-rating factor, which is also set as a parameter input into the model.

$$\sum_k (DF_k \cdot p_{kts}) = mres \cdot Dpeak_{ts} \quad \forall t, s$$

The sets considered in the model are the following:

Sets

Technology k  
Year t [1-70]  
Block b [1-1008]<sup>2</sup>  
Area s [1-9]

Therefore, the model can be schematized as follows,

Optimisation model, long-term capacity expansion model

Investment and operation decisions  
Min (CAPEX + OPEX + NSE cost)  
Capacity variable MW (k,t,s)  
Energy variable TWh (k,t,b,s)  
Physical constraints<sup>3</sup>

*Being,*

*NSE: Non-Served Energy*  
*ZAR: South African rands*

<sup>2</sup> 84 blocks/month defined because of computational reasons: 7 days x 24 hours/day result in 168 blocks

<sup>3</sup> Hydro constraints; production constraints



### **3.3 Model Simulation**

Once that all parameters are defined, they are translated into an Excel interface with the aim of generating a text file (.txt) that can be read in the GAMS project that has been created (.gms).

After exporting the Excel data into the text file, the model is executed. In order to provide some numbers about the magnitude of the project, simulations had taken on average 150 minutes each and throw a total around 13,272,000 single variables, 10,058,200 single equations and 310 000 simplex iterations to get to the optimal solution.

Once the simulation has reached the optimal, the solution is thrown to another text file which is later read in a second Excel file to process and analyse the information.

If a simulation error occurs in this stage, the compilation is stopped and the error messages are analysed to either change some assumption in the input parameters or change the definition of variables and formulation of equations in the GAMS code. To provide an example, an incorrect definition in the code of the parameters of the international connections triggered an error in the firsts simulations.

Once these errors are reviewed, the model is run again and the same iterative procedure is followed; reaching a total around 35 simulations.

### 3.4 Output Scan

When the optimal solution is reached, the model provides two different files which are explained below.

- *Blocks planning*

For each technology (k), year (t), block (b) and area (s), the following variables are calculated,

- Available capacity of conventional generation (CCGT, coal, nuclear, hydro and peakers)
- Available capacity of renewable generation (wind, solar PV, solar CSP, biomass, small hydro) are fixed and set as input parameters (*see section 3.1.1 Fundamentals – Renewable targets of this document*)
- Non Served Energy
- Renewable spillages
- Imports and exports
- Energy price

- *Monthly and annual planning:*

For each technology (k), year (t), and area (s), the following variables are calculated,

- Energy produced
- Installed capacity
- Energy Prices, dual variable of the energy balance equation
- Load factor
- Installed capacity for coverage index
- Economic retirement – this will happen whenever the model finds there is overcapacity in the system. The model will likely choose to retire a technology whenever it has high O&M fixed costs and investing in other technologies in the future may be more profitable.
- Retirement because of end of useful life – if not retired because of economic reasons, technologies will be retired if there is a restriction of decommissioning this technology by a certain year.
- Imports and exports
- Variable margin for each technology
- Capacity payment, dual variable of the capacity balance equation

In order to verify that the output is consistent, the following two conditions must be satisfied,

- Installed capacity for coverage index must be coherent with the installed capacity and the load coverage index set as input.
- The VAN for each technology must be zero: When discounting the cash flows each technology generates along its useful life at the specified discount rate – taking into account the overnight cost (CAPEX) plus the income the technology generates in the energy market plus the capacity payment- must equal zero. This means that the remuneration each technology gets equals exactly its investment and operation costs.

The summary of the methodology described in this section is depicted in the graphic below.

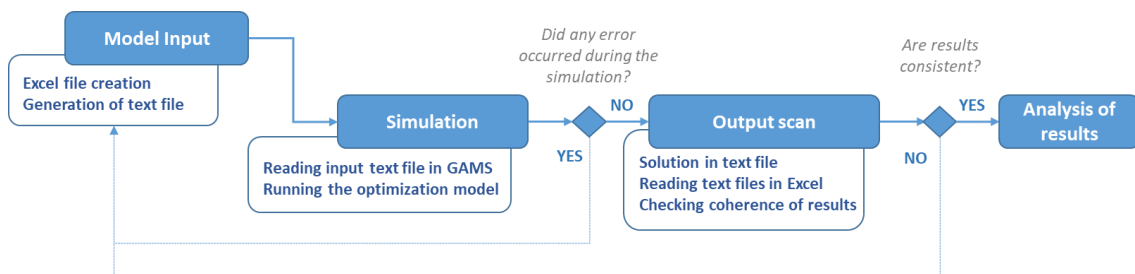

Figure 31. Followed methodology scheme



## Chapter 4. Results

The output results provided by the model are shown and analysed in detail in this chapter. After discussing these results, a study on the profitability that renewable technologies would get under these conditions is performed.

### 4.1 Power system expansion analysis

#### 4.1.1 Technology mix

The figure below represents the evolution of the capacity mix from 2019 to 2050 in South Africa.

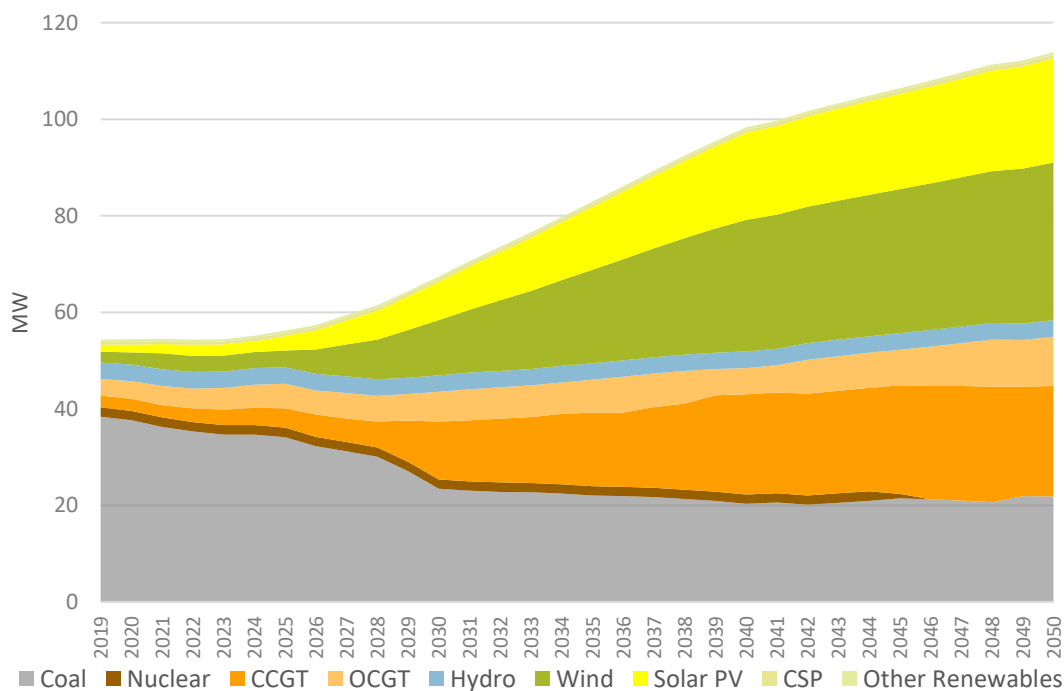

Figure 32. Capacity expansion outlook 2019-2050 in South Africa

An analysis focusing on ten-years windows is discussed next:

#### 2020-2030

As it can be observed in figure 32, the predominant technology in this decade is still coal – highlighted in grey in the figure. On one hand, this means that the current trend remains in the short-term but, on the other hand, it can be appreciated how the coal installed capacity start decreasing along the decade and other technology sources increase their share in the capacity mix.

This can be observed very clearly at the end of the decade, when there is a sharper drop on coal capacity. The reason of this is that most of existing Eskom's coal stations reach their end of useful life by these years. Therefore, the model is retiring these

plants from the mix and starts installing other technologies which are cheaper for the system.

Regarding renewables, a continuous growing path is observed in accordance to the renewable targets that were set. Hydro capacity remains constant, as already envisaged.

### **2030-2040**

Two key issues can be highlighted in these period:

First, a clear switch of coal to gas can be observed in the figure. As it was anticipated before, old-coal plants that have been decommissioned are substituted by more efficient and cheaper gas plants (CCGT's and OCGT's) – which correspond to the orange area in the figure.

Second, a sharp increase in renewable sources is observed in this decade. The share of renewable capacity in the system becomes very significant, with a large contribution of solar PV – yellow area – and on-shore wind – green area-.

### **2040 - 2050**

The most significant fact in this decade is the nuclear phase-out at the mid of the period. As it happened with the coal stations in the 2020-2030 period, the only Eskom's nuclear power plant located in Western Cape reaches the end of its useful life. By this time, it can be noted that the model invests in some new coals, which are more efficient than existing coals.

Finally, renewable capacity keeps its growing trend but at a slower rate, as it can be appreciated in the curve slope of on-shore wind and solar PV capacity.

A detailed table of the new capacity and retirements for each technology and year can be found in Annex B.

Focusing now on the generation mix, the figure below represents its evolution for the same range of time.

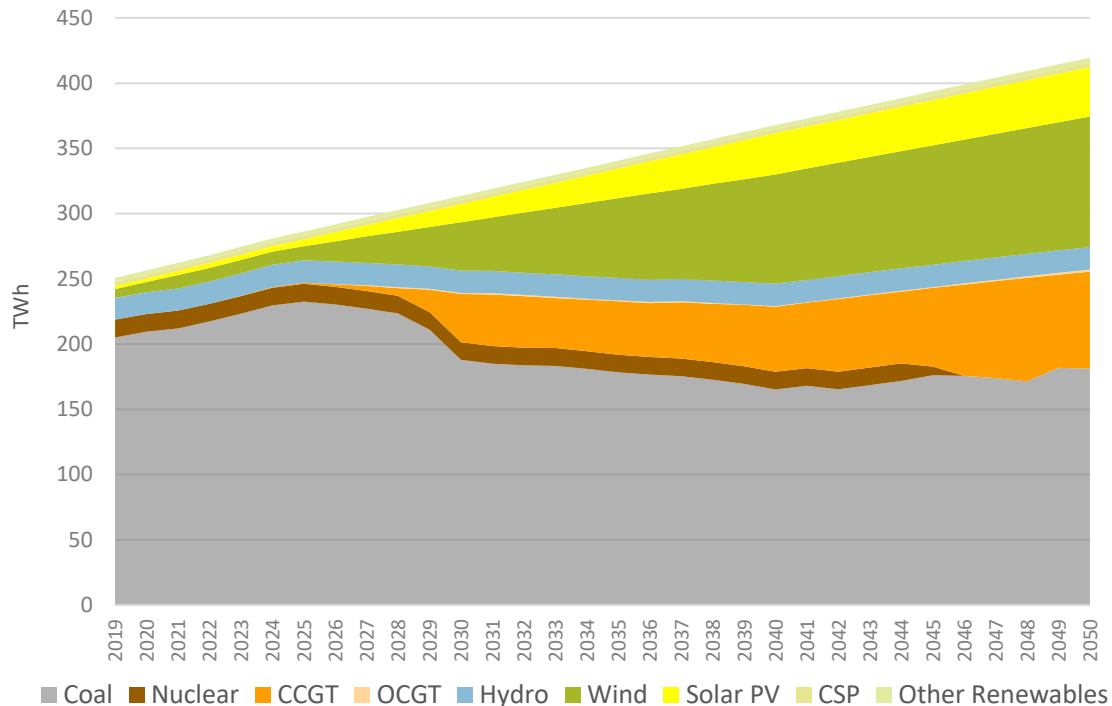

Figure 33. Generation expansion outlook 2019-2050 in South Africa

Following the same scheme as in the above discussion:

### 2020-2030

In accordance with the observations made when discussing the evolution of the capacity mix, it can be seen that coal plants have the largest share on the coverage of demand until the last years of the decade.

By 2028, a sudden drop on coal production is observed. This is due to the decommissioning of existing coal plants, as explained before.

Renewable generation contributes slightly to the coverage of demand, whereas hydro remains with an almost constant share along the decade.

### 2030-2040

As expected based on the capacity discussion, new gas plants in the system start producing instead of the retired coal. Therefore, it can be noted that the load factor of the CCGTs increases significantly with respect to the last decade.

On the other hand, the renewable share for demand coverage increases sharply.

### 2040 – 2050

In this decade, the following remarks can be observed:

First, the extinction of nuclear production, in accordance of the previous explanations about nuclear capacity decommissioning.

Second, a slight rise on coal production at the end of the decade can be noted. The phase-out of nuclear and the end of the useful life of some capacity of CCGTs by 2049 result in this increase.

#### 4.1.2 Renewable share

South Africa faces an energy transition from a power sector extremely reliable on coal to a green one in thirty-years' time. According to the renewable targets set in this paper based on the estimations of the Department of Energy of South Africa (see 3.1.1– *Fundamentals – Renewable targets*), the country will see a renewable share increase of 28%: It will jump from a 6% by 2018 to a 35% by 2050.

Note that the renewable share is calculated as the demand that is covered with renewable sources.

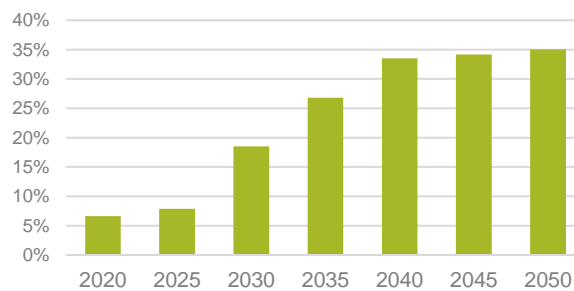

Figure 34. Evolution of the renewable share in South Africa for the period 2020-2050

It should be mentioned that the renewable increase will not be uniform in all provinces of the country. When analysing the share increase in each area, it can be noted that there are three provinces with an exponential growth rate versus a much modest growth rate in the rest of provinces. This is reasonable as the highest renewable potential is located in these areas, being the Eastern Cape the province with the highest wind resource and the Northern Cape the province with the highest solar resource.

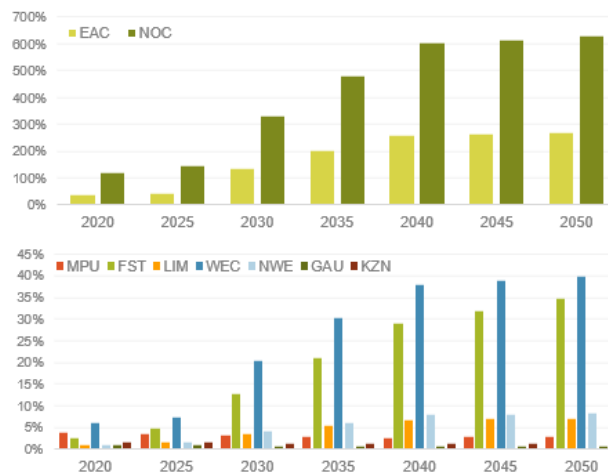

Figure 35. Evolution of the renewable share by province in the period 2020-2050<sup>4</sup>

<sup>4</sup> MPU- Mpumalanga; FST – Free State; LIM – Limpopo; WEC – Western Cape; EAC – Eastern Cape; NEW – North West; GAU – Gauteng; KZN – KwaZulu-Natal; NOC – Northern Cape



### 4.1.3 Analysis by province

As explained in section 3.4 of this document, the model provides with an expansion of the power system for each province.

The figure below schematizes the different evolution of the generation mix among areas.

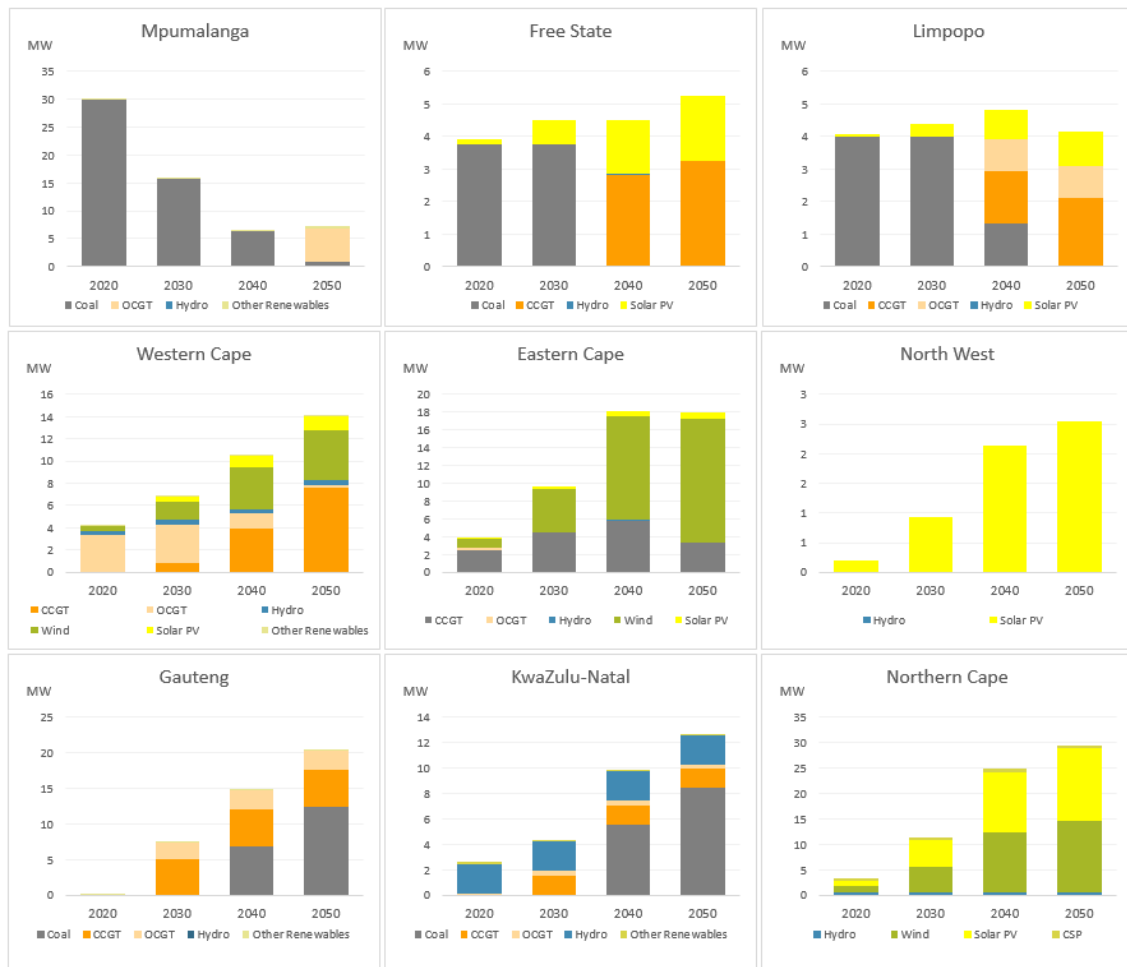

Figure 36. Capacity mix evolution by province in 2020-2030-2040-2050

As anticipated, there is a large difference in the long-term expansion of each province. To provide further details on these differences, the evolution of the average monthly profile of the coverage of demand is discussed in the following paragraphs for the Eastern Cape province and Gauteng province. The reason of further discussing these two areas is that they can be considered representative of two interesting cases: Eastern Cape is one of the provinces with the largest renewable penetration – as discussed in the precedent subsection- whereas Gauteng is the province with the highest demand.

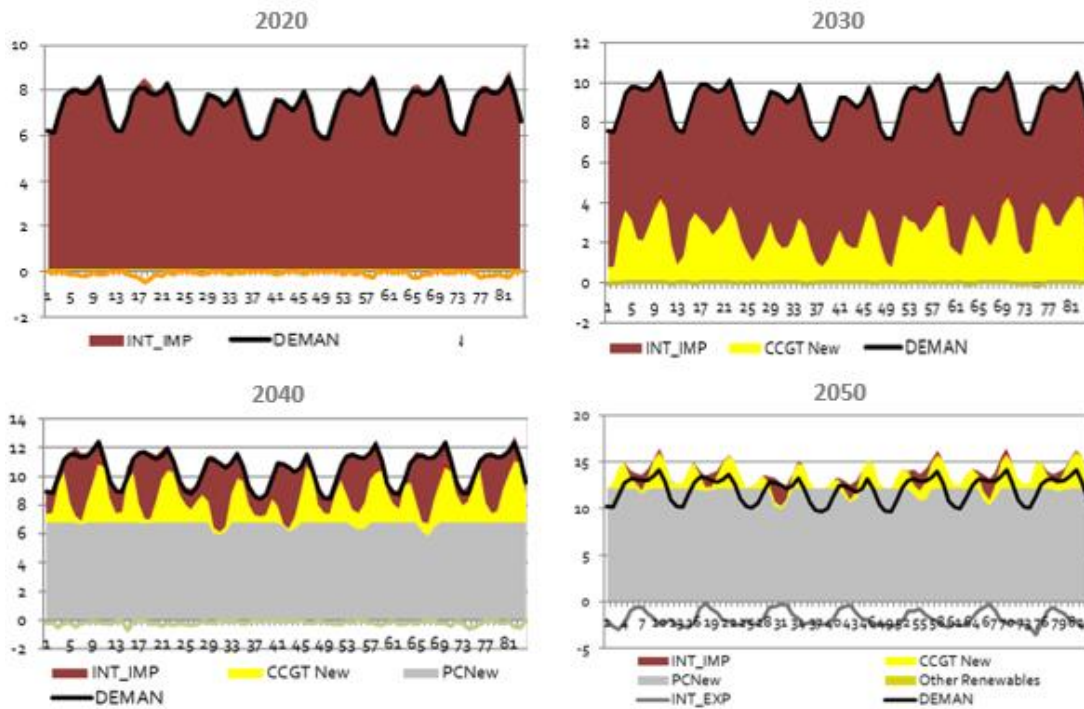

Figure 37. Average monthly generation profile evolution in Gauteng

In the case of Gauteng, which is an importer province, the evolution explained below can be noted:

By 2020, almost 100% of the demand is covered with imports from neighbouring provinces. However, if analysing the same average profile by 2030, it can be observed that some new CCGT's that have been commissioned in this decade are working mainly during peak hours. Therefore, the dark red area corresponding to imports has been reduced with respect to the 2020 average profile.

When focusing now in the 2040 average profile, a new area shadowed in grey can be noted. This area corresponds to new coals stations that have been commissioned during these ten years and work as baseload plants. CCGT's, as already observed in the 2030 profile, produce during peak hours and, finally, imports are largely reduced when compared to the starting point. Last but not least, it can be observed that by 2050 the demand is mainly covered by new coal stations, being the CCGT's the technology that produces in the peaks. Imports are reduced to specific hours.

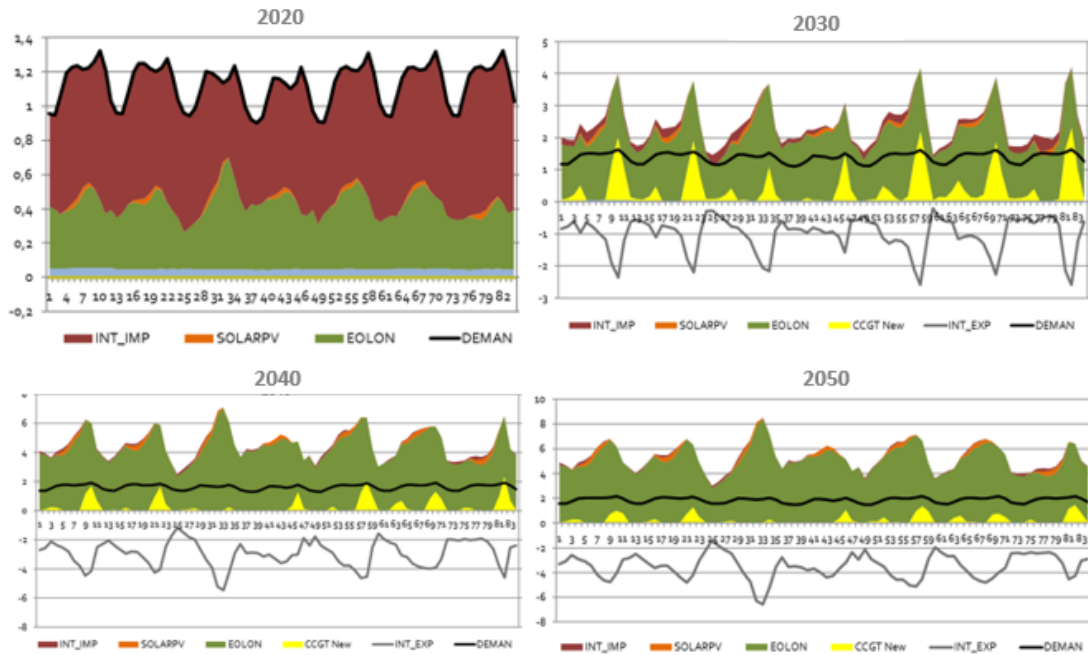

Figure 38. Average monthly generation profile evolution in Eastern Cape

By contrast, this analysis is very different if looking at the evolution of the average profile in Eastern Cape.

In this case, it can also be observed a large amount of imports by 2020, although a significant share of the demand is covered by renewable technologies, i.e., mainly wind and PV and run-of-the-river hydro to a lesser extent. However, by 2030, it should be noted that this province has become a net exporter, mainly due to the increase on wind production. It can be observed that some new CCGTs have been commissioned in this area as well – new yellow area appears in the figure – and they work during peak hours, same as discussed for Gauteng.

By 2030, wind penetration increases and therefore CCGTs participation in the mix decreases. As the renewable production rises, the exports to neighbouring provinces become larger too. Finally, as it can be seen in the last chart in figure 38, the profile by 2050 is very similar to the profile by 2040, being the wind production slightly higher.

Some reflexions can be brought in this point:

First, if the transmission corridors are not properly reinforced and therefore there is not enough capacity to evacuate this energy, there could be spillages in this area. This is, there would be a large amount of renewable generation and not enough evacuation capacity to other areas. This could be a sign of a potential area to install batteries.

Second, as the renewable penetration is that high, cannibalization could occur among renewable technologies in this case. This would mean that the high presence of these technologies in the market and increased competition among them lower market prices and the captured-price by these renewable technologies decreases.

## 4.2 Price evolution

The evolution of the energy price from 2019 to 2050 is shown in orange in the figure 34 below, being represented in real terms (South African Rands 2019 "ZAR<sup>19</sup>").

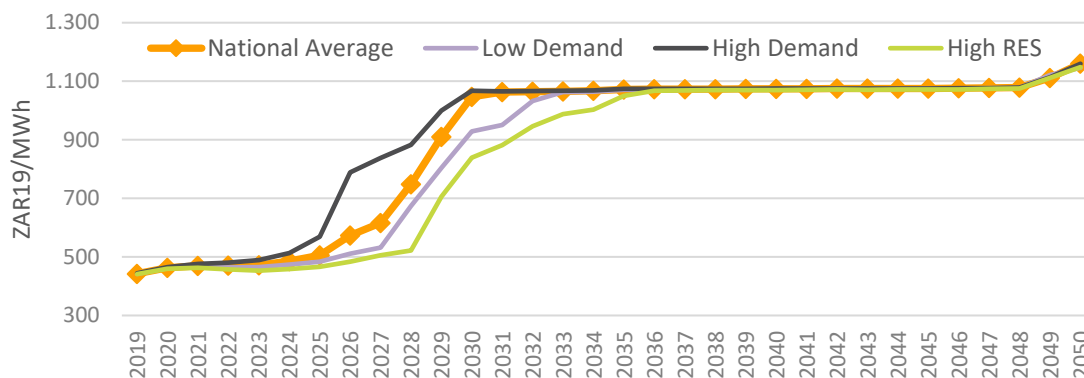

Figure 39. Price outlook 2019-2050 in South Africa

The observed trend can be summarized as follows:

Prices remain in the range of 450-500 ZAR<sup>19</sup>/MWh (39-35 Eur/MWh if considering ZAR-Eur exchange rate of 1 January 2019 according to the hypothesis –see 3.1.2 – *Economic Parameters of this document*–) until 2026. From this year until 2031, a strong increase is observed. This is justified by the abovementioned switch of existing coal plants - which use cheap coal as fuel- to gas. As the latter is the technology which sets the price most of the hours, the average price increases. The more coal stations are retired from the system in these five years, the more hours the gas sets the price and the higher the price gets.

However, from 2032 to 2050, the price path follows an almost stable trend around 1100 ZAR<sup>19</sup>/MWh (approximately 83 Eur/MWh). This contention in the price can be explained by the increase on renewable share: Gas technologies work in peak or stress hours for the system but the renewable sources are able to cover the demand in a large number of hours. Finally, a slight upturn can be noticed at the end of the period; once the nuclear is completely decommissioned and new coals and OCGTs are commissioned instead.

### 4.2.1 Price evolution under different scenarios

The model has been run under three additional scenarios to evaluate the sensitivity of the price to changes in the demand and to a larger renewable penetration, namely,

- i. Low Demand Scenario: Considers the lower forecast of demand included in the IRP (see 3.1.1 *Fundamentals of this document*).
- ii. High Demand Scenario: Considers the upper forecast of demand included in the IRP (see 3.1.1 *Fundamentals of this document*).
- iii. High Renewables Scenario: A more ambitious renewable target is considered.

Year	Base Case	High RES
2030	19%	30%
2040	33%	40%
2050	35%	50%

Table 8. Renewable targets under the high RES scenario

The following results can be observed,

- Price rockets by 2025 under the high demand scenario, reaching price levels of 800 ZAR<sup>19</sup>/MWh by 2026; which means an increase of 40% with respect to the base case. This is motivated by the sharp increase of CCGTs and OCGTs, which rise their production by three. However, it can be observed that the price follows a very similar path as in the base case from 2030. This occurs because the amount of gas needed in the system by this year on is not very sensitive to the differences on demand.
- When compared to the scenario of low demand, a very similar path can be observed but for the beginning of the 2030 decade. As opposite to the scenario of high demand, less amount of gas is needed in the system to cover the demand. Under this scenario, the price forecast reaches the level of 1100 ZAR<sup>19</sup>/MWh by 2033, a couple of years later than in the base case.
- This difference is more pronounced in the high renewables penetration scenario: The upraise on prices is much softer as renewables account for a larger share and therefore contain the price. The 1100 ZAR<sup>19</sup>/MWh level is reached by 2036 in this case; and, from this moment on, a similar trend is observed. This means that the sensitivity of the price to renewables penetration from this year when compared to the assumptions on the base case is low, as CCGTs and OCGTs are still needed to cover the projected demand (*medium series is considered for this scenario*).

### 4.3 Renewable profitability analysis

As the model has provided a forecast for future energy prices, the estimated income that technologies would get in the market can be also calculated. Based on this calculation, the future twenty-years income path for on-shore wind and solar PV is discounted at a set discount rate –see 3.1.2 – *Economic Parameters of this document*– with the aim of obtaining an estimated projection of the income these technologies would get as merchant.

This projection is then compared to the LCOE<sup>5</sup> for these technologies provided by Bloomberg NEF for 2018. ([NEFB18]) The projection of the LCOE curve in the long-term is calculated proportionally to the Spanish path.

LCOE (\$/MWh)	
<b>Wind on-shore</b>	
Upper	95
Lower	64
<b>Solar PV</b>	
Upper	69
Lower	63

Table 9. LCOE for renewable technologies

The expected income is forecasted for the base case scenario and three more scenarios: Two considering different levels of demand and one with high renewable penetration and the same level of demand as in the base case (medium). All curves are represented in real terms (ZAR<sup>19</sup>/MWh).

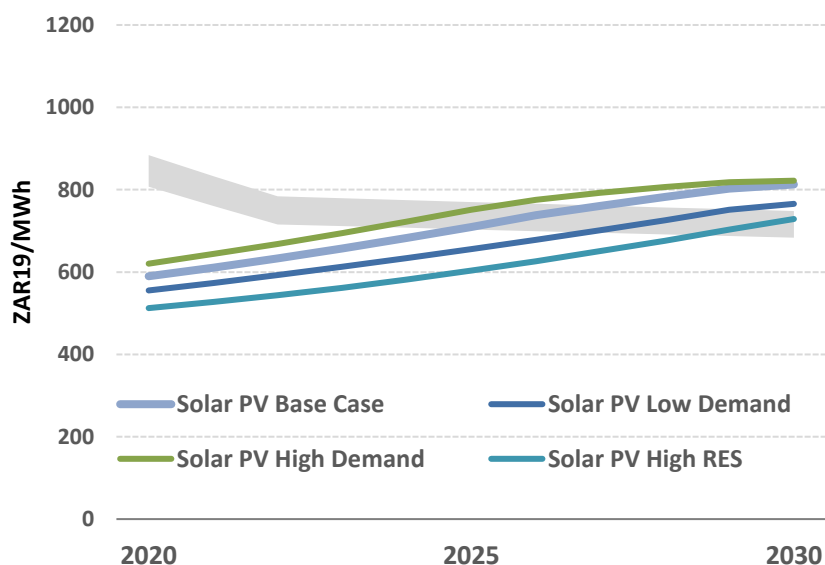

Figure 40. Profitability analysis of solar PV

<sup>5</sup> LCOE – Levelised Cost of Electricity

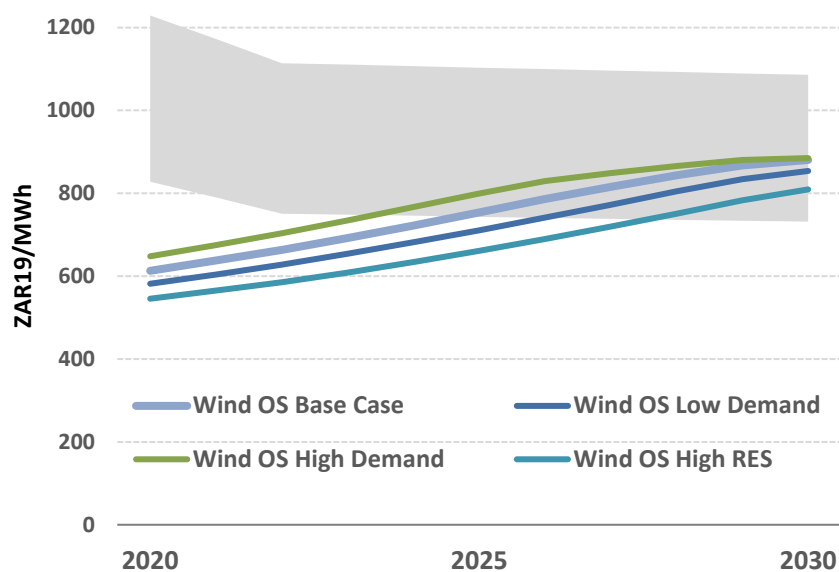

Figure 41. Profitability analysis of on-shore wind

Whenever the income projection is below the shaded area, the renewable technologies would not be profitable only based in the market incomes, meaning they would need an extra support mechanism to be profitable such as a feed-in tariff or feed-in premium.

Analysing the obtained results, it can be observed that this would be the case during the first years. However, it can be noted that, in general terms, by 2025 the income projection falls inside the shaded area, meaning that these technologies could recover their costs being merchant. The higher the demand, the sooner this point will be reached. However, it should be remarked that the sensitivity to the different levels of demand that the Department of Energy is forecasting is not that high. A slight difference can be observed in the curves.

However, some particularities can be differentiated between both technologies.

- On one hand, solar PV is more likely to become profitable in the medium and long-term. If observed in the figure, income projections reach costs by 2025 and are likely to get above these costs in the long-term. Therefore, solar PV would be able to get a margin from the market by then.
- On the other hand, wind on-shore expected income is also forecasted to cover its costs by 2025. However, on-shore wind income would not overpass its cost range, as it can be observed in the figure. This technology would therefore be competitive in the market: It would cover its costs without any extra support but no large margins are forecasted., although the income it gets from the market are slightly higher than solar PV – +5% in average.

It should be expected that these technologies could become profitable without any support before than referenced above, either because their learning cost curves decrease at a faster rate than forecasted or because the renewable penetration is not as large as anticipated. In this last case, there would be less cannibalization among technologies and their income in the market would be higher.

#### **4.3.1 Profitability analysis under different scenarios**

As it can be noticed in figures 40 and 41, there is no a large sensitivity on the profitability of solar PV and on-shore wind technologies under the different scenarios.

Both technologies are expected to be profitable in the market in the long-term in all cases, meaning that a larger share of renewables sources in the system could be possible. Until reaching a higher renewable penetration, the renewable income is driven by the price evolution of commodities.

It should be noted that under the high renewable scenarios, these technologies would need an extra support mechanism almost until the end of the period. However, if a scenario of high demand occurred, this might happen before 2025.



#### 4.4 Sensitivity analysis

As it has been mentioned, it is very relevant for the planned expansion of the power system that Eskom is capable of investing and developing accordingly the transmission infrastructure.

In this section, the capacity of the interconnection lines among provinces is limited to 10 GW – still considered as a large capacity based on previous analysis developed for other countries out of the scope of this Thesis-, with the aim of analysing the sensitivity that the limitation of interconnection capacity has in the expansion of the system.

This section covers the most relevant changes that have been observed.

- *Regarding technology mix*

Although the evolution of the different technologies in the mix follow the same trend, a larger contribution of OCGTs and specially coal can be noted. This is coherent as thermal generation increase its share in the coverage of the demand as zonal markets are decoupled.

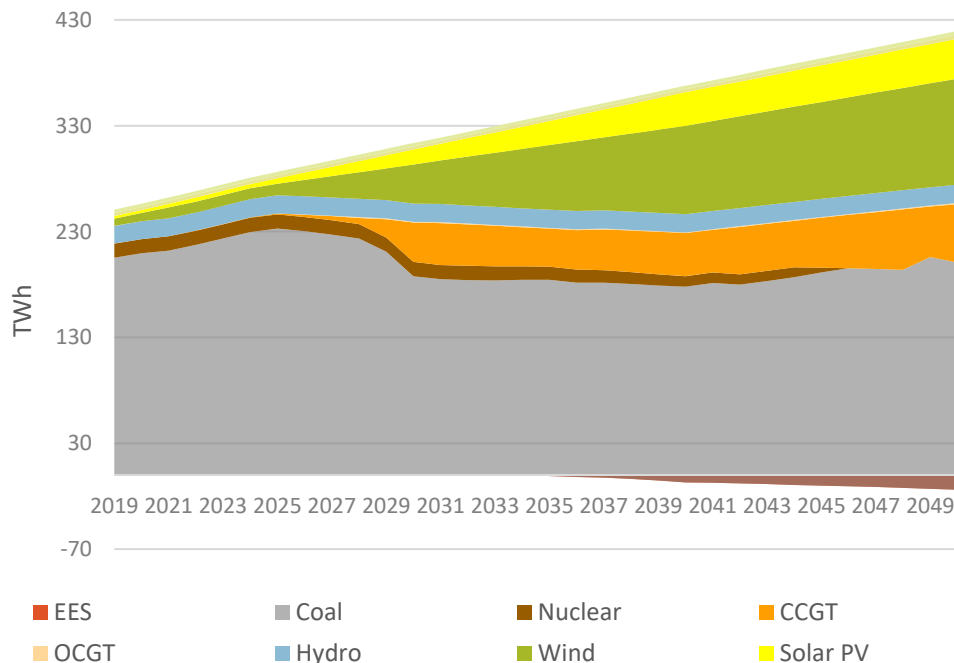

Figure 42. Evolution of the generation mix under the sensitivity analysis

However, the largest difference between this scenario and the base case is that spillages are observed from the mid of 2030s, as it is represented under the negative area in the figure above. This is due to the decoupling between areas: The total amount of renewable energy generated in the Eastern Cape and Northern Cape provinces cannot be properly evacuated. This does not happen in

the base case because it was assumed that there would not be congestions among areas.

As shown in the figure below, these spillages start to occur by mid of 2030s and keep rising until 2050, as renewable penetration increases and the capacity of the interconnectors remain the same.

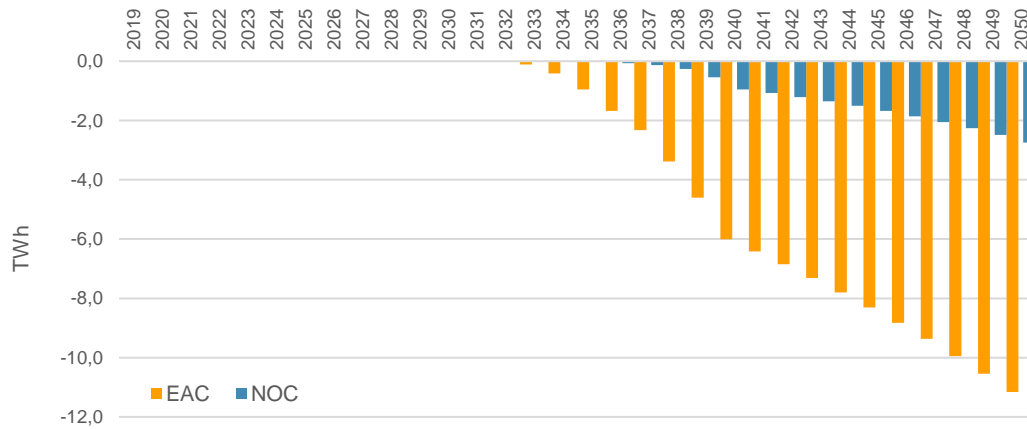

Figure 43. Evolution of spillages under the sensitivity analysis

- *Regarding energy prices*

When introducing a capacity limit in the interconnection between provinces, an interesting feature can be observed in the energy price path from 2032. As depicted in the figure below, zonal prices decouple into two major areas: Three provinces register a zonal price below the national average (Eastern Cape, Western Cape and Northern Cape), whereas the other six have a zonal price above the national reference.

This can be explained by the renewable penetration: The three provinces with lower prices are the three ones with the largest share of renewable sources. Therefore, these areas register “zero-prices” during a large number of hours during the year, resulting in a lower average price. However, gas is the technology that sets the price most of the hours in the rest of the provinces; which explains the higher average prices.

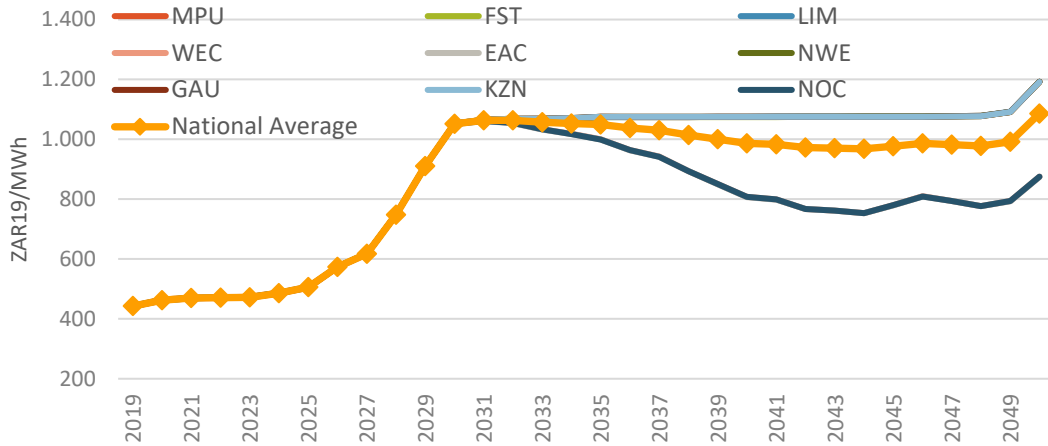

Figure 44. Price forecast under the sensitivity analysis

▪ *Regarding renewable profitability*

When studying the profitability of solar PV and on-shore wind under this scenario, it can be noted that renewable technologies are getting a lower income in the market and therefore become less profitable.

In the figure below, it is shown how the income may not be even enough to cover their costs. This means that the proper investment on reinforcements of the network is a risk for renewables profitability. If these transmission plans are not implemented and therefore there is a higher cannibalization, the renewables sources may not be competitive in the market and a support mechanism will be needed. It should be noted that the highest renewable generation would take place in the areas with the lowest market prices.

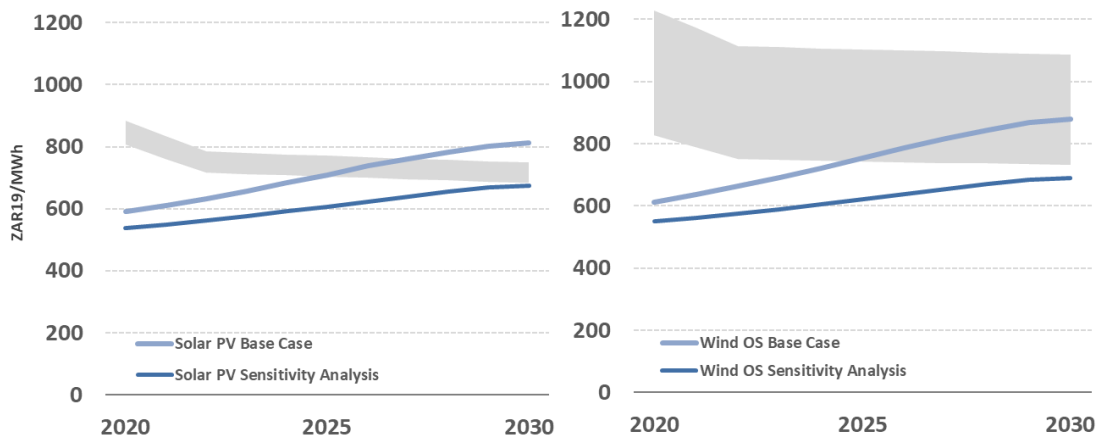

Figure 45. Renewable technologies profitability under the sensitivity analysis (ZAR<sup>19</sup>/MWh)



## Chapter 5. Conclusions

This chapter outlines some of the main conclusions that can be drawn from this study.

- The Republic of South Africa faces a relevant energy transition, mainly driven by the large growth of renewable sources and their corresponding integration in the system.
- The renewable potential in the country is high, although not uniformly distributed. A very relevant differentiation can be observed in the forecast of the provincial capacity and generation mix evolution.
- This allocation of renewable sources will likely require the reinforcement of transmission corridors from the Cape to the centre of the country, where the largest consumption areas are located and which are expected to experience a load growth.
- Gas is envisaged as a transition technology: CCGTs and OCGTs are expected to have a relevant share in the transition period from a coal-dominated to a green power system.
- On-shore wind and solar PV are expected to be profitable in the long-term, although they may need an extra support in the short and medium term to cover their costs. However, it could be expected that these technologies could be profitable before than projected if their cost curve has a sharper decrease; which is likely to happen.
- The profitability of these technologies is not very sensitive to the different levels of demand forecasted by the Department of Energy until 2050, as their income is led by the commodities price. This trend would not change until a higher renewable penetration is reached.
- However, attention should be paid to the cannibalization among technologies, especially in those provinces with the largest RES penetration. This could be identified as a potential risk on the zonal markets decoupling, meaning that the networks support plays an important role in the transition of the South African power system.

Finally, some guidelines on potential interesting developments for the future are provided below.

- New scenarios considering different projections of commodities could be performed, with the aim of studying the sensitivity on the evolution of the mix.
- Distributional differences provide some light on potential areas to install batteries. This possibility could be further analysed in future studies.
- A further analysis that would incorporate the flexibility of coal plants into the model, e.g., ramps constraints. This further study would allow to analyse if the existing thermal plants in the system are able to cope with the high renewable penetration in the system at all times.
- A further study focused on the interconnection modelling among provinces could be very interesting to enrich this study; which might provide a more accurate guidance on the energy transfers among neighbouring provinces. This is relevant because it is envisaged that congestions occur: The largest renewable increase will take place in areas far removed from load centres.

## References

- [CHAR17] *Preliminary Findings of the South Africa Power System Capacity Expansion and Operational Model Study*. NREL (National Renewable Energy Laboratory, U.S. Department of Energy). Chartan, E., Reber, T., Brinkman, G., 2017.
- [CPPA19] 21st Century Power Partnership. <http://www.21stcenturypower.org>.
- [CRES19] Centre for Renewable and Sustainable Energy Studies. <http://www.crses.sun.ac.za/research-publications-resources>.
- [CSIR17] *IRP Medium and Long Term Results Summary*, CSIR. 2016.
- [CSIR19] *CSIR, Energy Centre Documents. Wind and solar PV South Africa (Statistics)*
- [CSIS19] *Statistics of utility scale solar PV, wind and CSP in South Africa in 2018*, CSIR. 2019.
- [DOED19] *Load Factor for Provincial Data, Renewable Energy Data and Information Service, Department of Energy, Government of South Africa*. <http://redis.energy.gov.za/national/>.
- [DOEG10] *The South African Gas Sector, Department of Energy, Government Republic of South Africa*. 2010.
- [DOER10] *South African Energy Synopsis*. 2010.
- [DOER17] *Forecasts for Electricity Demand in South Africa (2017-2050) using the CSIR sectoral regression model*. 2017.
- [DOER19] *Department of Energy, Republic of South Africa*. [http://www.energy.gov.za/files/au\\_frame.html](http://www.energy.gov.za/files/au_frame.html).
- [DOMI08] Sánchez Domínguez, J.J., Centeno Hernández, E., Barquín Gil, J. *Generation Expansion - Decision Support Models in Electric Power Systems, Ph. D Thesis, Universidad Pontificia Comillas*. 2008.
- [EIAD17] *South Africa Overview, U.S. Energy Information Administration*. 2017.
- [ENGN15] *Engineering News, South Africa*. 2015.
- [ESIA18] *What is the IRP 2018?, ESI Africa (Africa's Power Journal)*. September 2018
- [ESKG18] *Generation License, Multi- Year Price Determination FY2019/20 - 2021/22, Eskom*. 2018.
- [ESKH19] *Eskom, Heritage*. <http://www.eskom.co.za/sites/heritage/Pages/default.aspx>
- [ESKM17] *Eskom Generation Plant Mix*. 2017.
- [ESKM19] *Eskom, South Africa*. <http://www.eskom.co.za/Pages/Landing.aspx>.

**[ESKP19]** Eskom, *Power Stations*.

[http://www.eskom.co.za/Whatweredoing/ElectricityGeneration/PowerStations/Pages/Power\\_Stations\\_And\\_Pumped\\_Storage\\_Schemes.aspx](http://www.eskom.co.za/Whatweredoing/ElectricityGeneration/PowerStations/Pages/Power_Stations_And_Pumped_Storage_Schemes.aspx).

**[ESKR]** *Multi-Year Price Determination for Revenue application*, Eskom. 2019.

**[ESKT17]** *Transmission Development Plan 2018-2027*, Eskom. 2017.

**[ESKW17]** *Eskom Fact Sheets, Hydro Electricity in South Africa*

**[GETI19]** *Energy Sector, Get. Invest, South Africa. Mobilising Renewable Energy Investments*. <https://www.get-invest.eu/market-information/south-africa/energy-sector/>.

**[GRSA13]** *Government of Republic of South Africa, National Development Plan 2030*. February, 2013.

**[GRSA15]** *Strategic Plan 2015-2020, Department of Energy, Government of Republic of South Africa*. 2015.

**[GRSA17]** *State of Renewable Energy in South Africa, Government of Republic of South Africa*. 2017.

**[GRSA18]** *Draft Integrated Resource Plan, Department of Energy, Government of Republic of South Africa*. August 2018.

**[IPPP19]** *IPP Projects*. 2019.

**[IREN15]** *IRENA, Analysis of Infrastructure for Renewable Power in Eastern and Southern Africa*. 2015.

**[NEFB18]** *South Africa Climatescope, Bloomberg NEF*, 2018

**[RENE15]** *REN21, SADC Renewable Energy and Energy Efficiency Status Report*. 2015

**[SAPP18]** *SAPP Annual Report*. 2018.

**[SAPP19]** *South African Power Pool*. <http://www.sapp.co.zw/>.

**[STAT19]** *Statistics South Africa, Government of the Republic of South Africa. Electricity generated and available for distribution, April 2019*. <http://www.statssa.gov.za>.

**[TGEC19]** *The Global Economy, The World Bank*. <https://www.theglobaleconomy.com/compare-countries/>.

**[WASA19]** *Wind Atlas for South Africa, Department of Energy, Republic of South Africa* <http://www.wasaproject.info/>.



## Annex A: Input parameters

### Existing technologies information: Main operating costs

Province	Plant Id	Unavail. Index (Forced + Planned)	O&M <sub>i</sub> ZAR/kW	Fixed ZAR/kW	Current age	Type	O&M <sub>v</sub> ZAR/MWh	η (%)	CO <sub>2</sub> kg/kWh
MPU	ARN	3,3%	650	650	50	Coal	80,00	35,6%	1,1
MPU	CAM	3,7%	650	650	53	Coal	80,00	32,0%	1,1
MPU	DUV	5,6%	650	650	50	Coal	80,00	37,6%	1,1
MPU	GRO	3,7%	650	650	54	Coal	80,00	32,9%	1,1
MPU	HEN	3,7%	650	650	50	Coal	80,00	34,2%	1,1
MPU	KEN	3,7%	650	650	50	Coal	80,00	35,3%	1,1
MPU	KOM	3,7%	650	650	60	Coal	80,00	30,0%	1,1
MPU	KRI	3,7%	650	650	50	Coal	80,00	35,0%	1,1
MPU	MAJ	3,7%	650	650	50	Coal	80,00	36,5%	1,1
MPU	MAT	3,7%	650	650	50	Coal	80,00	37,6%	1,1
MPU	TUT	3,7%	650	650	50	Coal	80,00	38,0%	1,1
MPU	KUS	3,7%	650	650	50	Coal	80,00	36,7%	1,1
MPU	SAS	15,0%	650	650	50	Coal	80,00	36,7%	1,1
MPU	SSG	11,0%	161	161	30	Gas	2,41	31,0%	0,6
MPU	SAP	10,0%	1.655	1.655	30	Biomass	70,00	25,0%	1,2
FST	LET	3,7%	650	650	50	Coal	80,00	38,0%	1,1
FST	SAI	3,7%	650	650	50	Coal	80,00	36,7%	1,1
FST	SIG	11,0%	161	161	30	Gas	2,41	31,0%	0,6
LIM	MAB	6,3%	650	650	50	Coal	80,00	35,6%	1,1
LIM	MED	6,3%	650	650	50	Coal	80,00	36,7%	1,1
WEC	KOE	18,3%	650	650	60	Nuclear	37,19	33,5%	0,0
WEC	ACA	4,6%	161	161	50	Gas	2,41	28,8%	0,6
WEC	ANK	4,6%	161	161	30	Gas	2,41	35,0%	0,6
WEC	GOU	4,6%	161	161	30	Gas	2,41	35,0%	0,6
EAC	POR	4,6%	161	161	50	Gas	2,41	28,8%	0,6
EAC	DED	4,6%	161	161	30	Gas	2,41	31,0%	0,6
GAU	KEL	3,7%	650	650	56	Coal	80,00	36,7%	1,1
KZN	AVO	4,6%	161	161	30	Gas	2,41	31,0%	0,6

### Existing technologies information: Detailed list of existing groups

Power Station	Group	Rated Capacity MW	Comissioning Date	Forecast Year of Retirement
Arnot	ARN1	370	1972	2021
Arnot	ARN2	390	1971	2026
Arnot	ARN3	396	1971	2026
Arnot	ARN4	396	1974	2027
Arnot	ARN5	400	1974	2029
Arnot	ARN6	400	1975	2029
Camden	CAM1	200	1972	2023
Camden	CAM2	200	1971	2022
Camden	CAM3	200	1971	2022
Camden	CAM4	196	1974	2021
Camden	CAM5	195	1974	2021
Camden	CAM6	195	1975	2020
Camden	CAM7	190	1968	2020
Camden	CAM8	185	1968	2021
Duvha	DUV1	600	1968	2030
Duvha	DUV2	600	1968	2030
Duvha	DUV3	600	1968	Removed for production planning purposes
Duvha	DUV4	600	1968	2032
Duvha	DUV5	600	1968	2033
Duvha	DUV6	600	1968	2034
GrootMei	GRO1	200	1980	2025
GrootMei	GRO2	200	1980	2026
GrootMei	GRO3	200	1981	2027
GrootMei	GRO4	190	1982	Removed for production planning purposes
GrootMei	GRO5	180	1983	Removed for production planning purposes
GrootMei	GRO6	160	1984	Removed for production planning purposes
Hendrina	HEN1	160	1972	Removed for production planning purposes
Hendrina	HEN2	200	1972	2025
Hendrina	HEN3	185	1972	Removed for production planning purposes
Hendrina	HEN4	200	1972	2021
Hendrina	HEN5	200	1972	2022
Hendrina	HEN6	200	1972	2023
Hendrina	HEN7	200	1973	2021
Hendrina	HEN8	195	1973	2026
Hendrina	HEN9	195	1970	2020
Hendrina	HEN10	168	1970	2020
Kendal	KEN1	686	1988	2038
Kendal	KEN2	686	1989	2039
Kendal	KEN3	686	1990	2040
Kendal	KEN4	686	1991	2041
Kendal	KEN5	686	1992	2042
Kendal	KEN6	686	1992	2042
Komati	KOM1	91	1988	Removed for production planning purposes
Komati	KOM2	91	1989	Removed for production planning purposes
Komati	KOM3	90	1990	2028
Komati	KOM4	100	1991	2026
Komati	KOM5	100	1992	2026
Komati	KOM6	114	1992	Removed for production planning purposes
Komati	KOM7	125	1961	2025
Komati	KOM8	125	1962	2023
Komati	KOM9	125	1963	2023

Power Station	Group	Rated Capacity MW	Comissioning Date	Forecast Year of Retirement
Kriel	KRI1	500	1976	2026
Kriel	KRI2	500	1977	2027
Kriel	KRI3	500	1966	2028
Kriel	KRI4	500	1978	2028
Kriel	KRI5	500	1979	2029
Kriel	KRI6	500	1979	2029
Majuba	MAJ1	657	1996	2046
Majuba	MAJ2	657	1997	2047
Majuba	MAJ3	657	1998	2048
Majuba	MAJ4	713	1999	2049
Majuba	MAJ5	713	2000	2050
Majuba	MAJ6	713	2001	2051
Matla	MAT1	600	1996	2029
Matla	MAT2	600	1997	2030
Matla	MAT3	600	1998	2030
Matla	MAT4	600	1999	2031
Matla	MAT5	600	2000	2032
Matla	MAT6	600	2001	2033
Tutuka	TUT1	609	1979	2029
Tutuka	TUT2	609	1980	2030
Tutuka	TUT3	609	1980	2030
Tutuka	TUT4	609	1981	2031
Tutuka	TUT5	609	1982	2032
Tutuka	TUT6	609	1983	2033
Kusile	KUS6	799	1985	2077
Sasol Synfuel Coal	SAS1	60	1986	Post 2050
Sasol Synfuel Coal	SAS2	60	1987	Post 2050
Sasol Synfuel Coal	SAS3	60	1988	Post 2050
Sasol Synfuel Coal	SAS4	60	1989	Post 2050
Sasol Synfuel Coal	SAS5	60	1990	Post 2050
Sasol Synfuel Coal	SAS6	60	2017	Post 2050
Sasol Synfuel Coal	SAS7	60	1982	Post 2050
Sasol Synfuel Coal	SAS8	60	1982	Post 2050
Sasol Synfuel Gas	SSG1	250	2012	Post 2050
Sappi	SAP1	144	2018	Post 2050
Lethabo	LET1	618	1985	2035
Lethabo	LET2	618	1986	2036
Lethabo	LET3	618	1987	2037
Lethabo	LET4	618	1988	2038
Lethabo	LET5	618	1989	2039
Lethabo	LET6	618	1990	2040
Sasol Infrachem Coal	SAI1	13,5	1954	2004
Sasol Infrachem Coal	SAI2	25	1997	2047
Sasol Infrachem Coal	SAI3	13,5	1954	2004
Sasol Infrachem Coal	SAI4	25	1964	2014
Sasol Infrachem Coal	SAI5	25	1967	2017
Sasol Infrachem Coal	SAI6	12,5	1969	2019
Sasol Infrachem Coal	SAI7	12,5	1982	2032
Sasol Infrachem Coal	SAI8	12,5	1982	2032
Sasol Infrachem Gas	SIG1	175	2018	Post 2050

Power Station	Group	Rated Capacity MW	Comissioning Date	Forecast Year of Retirement
Matimba	MAB1	665	1987	2037
Matimba	MAB2	665	1988	2038
Matimba	MAB3	665	1989	2039
Matimba	MAB4	665	1990	2040
Matimba	MAB5	665	1991	2041
Matimba	MAB6	665	1991	2041
Medupi	MED1	794	2015	2065
Medupi	MED2	794	2017	2067
Medupi	MED3	794	2017	2067
Koeberg	KOE1	970	1984	2045
Koeberg	KOE2	970	1985	2046
Acacia	ACA1	57	1976	2026
Acacia	ACA2	57	1976	2026
Acacia	ACA3	57	1976	2026
Ankerling	ANK1	149,2	2007	2037
Ankerling	ANK2	149,2	2007	2037
Ankerling	ANK3	149,2	2007	2037
Ankerling	ANK4	149,2	2007	2039
Ankerling	ANK5	148,3	2008	2039
Ankerling	ANK6	148,3	2008	2039
Ankerling	ANK7	148,3	2008	2039
Ankerling	ANK8	148,3	2009	2039
Ankerling	ANK9	148,3	2009	2039
Gourikwa	GOU1	149,2	2007	2038
Gourikwa	GOU2	149,2	2007	2038
Gourikwa	GOU3	149,2	2007	2039
Gourikwa	GOU4	149,2	2008	2039
Gourikwa	GOU5	149,2	2008	2039
Port Rex	POR1	57	1976	2026
Port Rex	POR2	57	1976	2026
Port Rex	POR3	57	1976	2026
Dedisa	DED1	171	2015	2045
Dedisa	DED2	171	2015	2045
Kelvin	KEL1	30	1957	2007
Kelvin	KEL2	30	1957	2007
Kelvin	KEL3	30	1957	2007
Kelvin	KEL4	30	1957	2007
Kelvin	KEL5	30	1957	2007
Kelvin	KEL6	30	1957	2007
Kelvin	KEL7	60	1963	2013
Kelvin	KEL8	60	1963	2013
Kelvin	KEL9	60	1963	2013
Kelvin	KEL10	60	1963	2013
Kelvin	KEL11	60	1963	2013
Kelvin	KEL12	60	1963	2013
Kelvin	KEL13	60	1963	2013
Avot	AVO1	171,25	2015	2045
Avot	AVO2	171,25	2015	2045
Avot	AVO3	171,25	2015	2045
Avot	AVO4	171,25	2015	2045

**Annex B: Evolution of the installed capacity in the period 2019-2050**

Base Case

Year	Annual Capacity Decommissioning (GW)	Annual Capacity Commissioning (GW)	Year	Annual Capacity Decommissioning (GW)	Annual Capacity Commissioning (GW)
2019	0,0	4,0	2036	-0,9	4,1
2020	-0,7	0,8	2037	-2,0	5,2
2021	-1,3	1,5	2038	-2,5	5,6
2022	-0,9	0,8	2039	-3,4	6,4
2023	-0,7	0,7	2040	-2,0	4,9
2024	0,0	0,7	2041	-2,0	3,4
2025	-0,5	1,6	2042	-1,4	3,4
2026	-2,2	3,4	2043	0,0	1,6
2027	-1,1	3,2	2044	0,0	1,6
2028	-1,1	3,1	2045	-1,0	2,5
2029	-3,0	6,0	2046	-1,6	3,2
2030	-3,6	6,7	2047	-0,7	2,3
2031	-1,2	4,4	2048	-0,7	2,4
2032	-2,0	4,9	2049	-4,3	5,2
2033	-1,8	4,8	2050	-1,0	2,7
2034	-0,6	3,8			
2035	-1,4	4,6			

**Annex C: Evolution of RES income under different scenarios**

