



# MÁSTER EN INGENIERÍA PARA LA MOVILIDAD Y SEGURIDAD

TRABAJO FIN DE MÁSTER

## Manufacture and Testing of a Formula Student Suspension

Autor: Antonio Hernández-Ros Briales

Director: Ignacio Granell Heredero

Madrid

Junio de 2023

Declaro, bajo mi responsabilidad, que el Proyecto presentado con el título

**Manufacture and Testing of a Formula Student Suspension**

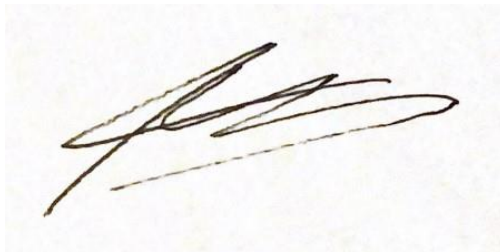
en la ETS de Ingeniería - ICAI de la Universidad Pontificia Comillas en el

curso académico 2022/23 es de mi autoría, original e inédito y

no ha sido presentado con anterioridad a otros efectos.

El Proyecto no es plagio de otro, ni total ni parcialmente y la información que ha sido

tomada de otros documentos está debidamente referenciada.



Fdo.: Antonio Hernández-Ros Briales

Fecha: 20/07/2023

Autorizada la entrega del proyecto

EL DIRECTOR DEL PROYECTO



Fdo.: Ignacio Granell Heredero

Fecha: 20/07/2023





# MÁSTER EN INGENIERÍA PARA LA MOVILIDAD Y SEGURIDAD

TRABAJO FIN DE GRADO

## Manufacture and Testing of a Formula Student Suspension

Autor: Antonio Hernández-Ros Briales

Director: Ignacio Granell Heredero

Madrid

Junio de 2023

# Acknowledgements

Upon reaching the culmination of my Engineering studies, I am filled with immense gratitude for the unwavering support and guidance I have received from those who have accompanied me throughout this journey.

To Ignacio Granell, the best person to lead this project. Your expertise, guidance, and patience have been invaluable. Working with a Formula 1 engineer has been an honour.

To the ISC Formula Student Racing Team, whose relentless passion, teamwork, and perseverance have inspired me to give my best.

To the Dynamics & Suspension department, you have taught me so much more than I could have ever contributed. Without a doubt, you are the best department in the entire project.

To my Technical Directors Enrique and Íñigo, your trust and expertise have been instrumental in motivating me to attend lectures and work diligently on the car.

To my family, thank you for your unwavering support and genuine interest in all my projects. Your encouragement and belief in me have been a constant source of motivation.

To my friends, for bringing joy and sharing wonderful moments that have enriched my life. Your presence and friendship have brought happiness and laughter to my journey.



# MANUFACTURE AND TESTING OF A FORMULA STUDENT SUSPENSION

**Author: Antonio Hernández-Ros Briales**

Supervisor: Ignacio Granell Heredero

## ABSTRACT

**Keywords:** Adhesive bonding, Carbon-fiber composite, Suspension components, Aluminium inserts, Manufacturing process, Bond strength, Surface preparation, Adhesive curing, Composite-aluminium bonding, Mechanical testing, Non-destructive testing, Optimization, Structural integrity, Automotive engineering, Performance enhancement

## 1. Introduction

In the dynamic world of motorsport engineering, the pursuit of optimal performance and safety has driven continuous innovation in vehicle design and components. As the automotive landscape evolves, lightweight materials and advanced manufacturing techniques have gained prominence, offering the potential to enhance vehicle dynamics and efficiency. Within this context, the integration of carbon-fiber suspension components has emerged as a critical focus area for improving the performance of race cars. This master's Thesis delves into the intricate realm of adhesive bonding as a pivotal process in fabricating reliable and high-performance carbon-fiber suspension components.



*Figure 1: IFS 04*

Carbon-fiber composites are known for their exceptional strength-to-weight ratio and durability, making them an ideal choice for enhancing the suspension system's efficiency. Adhesive bonding plays a vital role in joining different materials, such as carbon-fiber and aluminum, while maintaining structural integrity and reducing weight. This Thesis explores the development, testing, and optimization of an adhesive bonding process tailored to the unique demands of carbon-fiber suspension components. By achieving robust bonds, the Thesis contributes to advancing the performance and safety of motorsport vehicles. [1]

The primary objective of this study is to design, develop, and validate an adhesive bonding process for carbon-fiber suspension components. The research focuses on achieving high bond strength and durability while optimizing the manufacturing process. Specific objectives include:

- Investigating the state of the art in adhesive bonding techniques, composite-aluminum bonding, and material characteristics.
- Developing a comprehensive manufacturing process for preparing surfaces, applying adhesive, and assembling components.
- Evaluating the bond strength and durability of the adhesive-bonded components through destructive and non-destructive testing methods.
- Analyzing the results to assess the effectiveness of the adhesive bonding process and its implications for suspension performance.

The successful implementation of an optimized adhesive bonding process for carbon-fiber suspension components holds immense significance for motorsport engineering. Lightweight and strong suspension components directly impact vehicle handling, responsiveness, and overall performance on the track. Moreover, this research contributes to the broader field of composite material integration in the automotive industry.

The scope of this study encompasses the entire adhesive bonding process, from surface preparation to testing, and aims to address challenges related to bond strength, durability, and manufacturability. By presenting a comprehensive framework for adhesive bonding, this Thesis equips engineers and designers with valuable insights and methodologies to enhance suspension systems' quality and performance.

In the subsequent sections, this Thesis elaborates on the research's objectives, delves into the state of the art in adhesive bonding techniques, presents the suspension manufacturing and testing process, discusses the conclusions drawn from the research, and provides a list of references for further exploration.



*Figure 2: suspension arm exploded*



## 2. Objectives

The current phase of research is dedicated to the meticulous exploration, analysis, and refinement of the manufacturing process and testing protocols for carbon fiber tubes integrated with aluminum inserts, utilizing structural epoxy adhesive. The overarching goal is to attain an exhaustive comprehension of the fabrication intricacies and performance attributes of these composite tubes. To this end, a set of specific objectives has been outlined to steer this research endeavor:

### **Manufacturing Process Optimization:**

- ✓ Develop an intricately detailed manufacturing process for crafting carbon fiber tubes with seamlessly integrated aluminum inserts.
- ✓ Explore a spectrum of fabrication methodologies encompassing soldering, bonding, and lay-up techniques, culminating in the identification of the most pertinent approach.
- ✓ Immerse in the refinement of the resin infusion process to ensure the uniform and equitable dispersion of the epoxy adhesive within the composite framework.
- ✓ Delve into the intricacies of the curing process to realize the precise mechanical attributes and adhesive bonding prowess envisioned.

### **Material Selection and Characterization:**

- ✓ Undertake an all-encompassing characterization of carbon fiber materials, unveiling their mechanical attributes, including tensile strength, stiffness, and resilience against fatigue.
- ✓ Assess a diverse array of aluminum inserts and ultimately elect a fitting alloy that harmoniously complements the material characteristics of the composite.
- ✓ Conduct compatibility tests, critically examining the adhesive bonding dynamics between carbon fiber, epoxy adhesive, and aluminum inserts.

### **Adhesive Application and Bonding:**

- ✓ Discern the quintessential epoxy adhesive formulation that effectively ushers in a robust and enduring bond between the carbon fiber tube and aluminum insert.
- ✓ Engineer an optimal suite of surface preparation methodologies that confer heightened adhesive bonding tenacity.
- ✓ Precisely ascertain the adhesive curing parameters—spanning temperature, pressure, and curing duration—to instill reliability and consistency in the bonding process.

### **Structural Integrity and Mechanical Performance:**

- ✓ Undertake an incisive structural analysis to assess the load-bearing capacity and the intricate distribution of stress throughout the carbon fiber tube with integrated aluminum insert.
- ✓ Probe the resistance threshold of the composite under the most demanding loading scenarios.
- ✓ Engage in a series of exhaustive tests designed to identify the endurance limit of the composite and to scrutinize its enduring durability.
- ✓ Unearth the repercussions posed by environmental influences such as temperature and humidity on the adhesive bond and the overarching composite behavior.

### **Non-Destructive Evaluation:**

- ✓ Carve out a comprehensive testing protocol meticulously engineered to confidently unearth flaws and aberrations nestled within the composite structure.

### **Optimization and Validation:**

- ✓ Initiate a cyclical iterative process that revamps the manufacturing process and the adhesive application techniques, leveraging insights harvested from testing and meticulous characterization.
- ✓ Validate the epitome of the optimized manufacturing process and adhesive bonding technique through an assortment of repetitive mechanical and durability tests.
- ✓ Undertake a thorough juxtaposition of test outcomes with analytically forecasted projections, ultimately cementing the precision and veracity of the manufacturing and testing paradigms.

The resolute attainment of these multifaceted objectives shall reverberate through the annals of composite material science and manufacturing methodologies. These achievements shall significantly enrich the corpus of knowledge concerning the design and performance augmentation of composite structures laced with aluminum inserts, perpetuating their advancement.

### 3. State of art

#### **Adhesive bonding**

Adhesive bonding is pivotal for joining dissimilar materials like composites and aluminum. This section outlines advanced techniques for composite-aluminum bonding and delves into diverse adhesive types. [2]

- **Composite aluminum bonding**

Achieving a durable bond between composites and aluminum demands effective surface preparation, adhesive selection, and suitable bonding methods. Adhesion promoters and methods like wet layup, film adhesives, and paste adhesives enhance bond quality.

- **General adhesives and bonding methods**

Adhesives serve varied industries. Cyanoacrylate adhesives cure instantly, polyurethane adhesives offer flexibility, acrylic adhesives excel in optical applications, anaerobic adhesives cure without air, and UV-curable adhesives cure rapidly.

#### **Mechanical tests**

- **Destructive testing**

Peel and shear tests evaluate bond strength. Documentation records test details, equipment, parameters, and observations. [3]

- Peel testing

Peel tests measure bond strength through controlled separation. Documentation includes test specifics, equipment, and observations.

- Shear testing

Shear tests assess lateral forces' impact on the adhesive. Documentation records test details, equipment, parameters, and observations.

- Microscopy Examination

Microscopy examines separated composite and aluminum surfaces. Documentation includes test specifics, equipment, and observations.

- **Non-destructive testing**

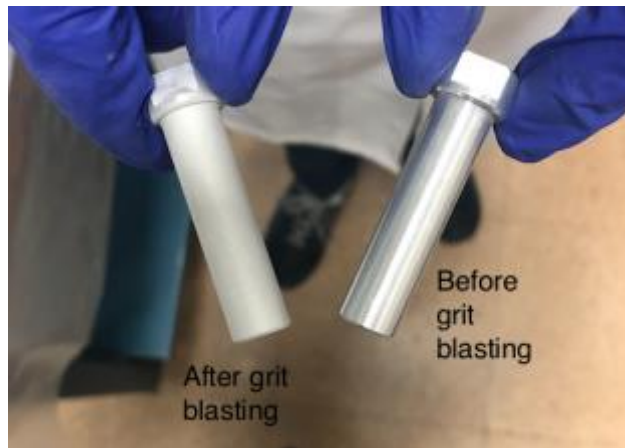
Non-destructive tests verify bonding quality without compromising components. Visual inspection, ultrasonic testing, shearography, and thermography ensure reliability.

#### 4. Suspension manufacture and testing

- **Suspension manufacture**

##### **Prepare Inserts and Tubes for Bonding:**

- Step 1: Activate Compressor
- Step 2: Grit-Blasting Equipment Preparation
- Step 3: Insert Grit-Blasting
- Step 4: Post-Grit Blasting Procedures



*Figure 3: inserts blasting*

##### **Prepare Carbon-Fiber Tubes:**

- Step 1: Tube Edge Sanding
- Step 2: Interior Sanding
- Step 3: Cleaning and Drying



*Figure 4: carbon fiber sanding*

### **Adhesive Bonding:**

- Step 1: Adhesive Cartridge Setup
- Step 2: Adhesive Application
- Step 3: Repeat for Other Side
- Step 4: Alignment Check



*Figure 5: adhesive bonding*

### **Cleanup:**

- Step 1: Adhesive Cartridge Maintenance
- Step 2: General Cleanup

- **Suspension testing**

### **Adhesive Bond Strength Testing:**

- Step 1: Specimen Preparation
- Step 2: Test Setup
- Step 3: Initialization and Calibration
- Step 4: Testing
- Step 5: Data Collection
- Step 6: Analysis and Result
- Step 7: Interpretation
- Step 8: Documentation



*Figure 6: suspension testing tube*

- **Results:**

**Test 1:**

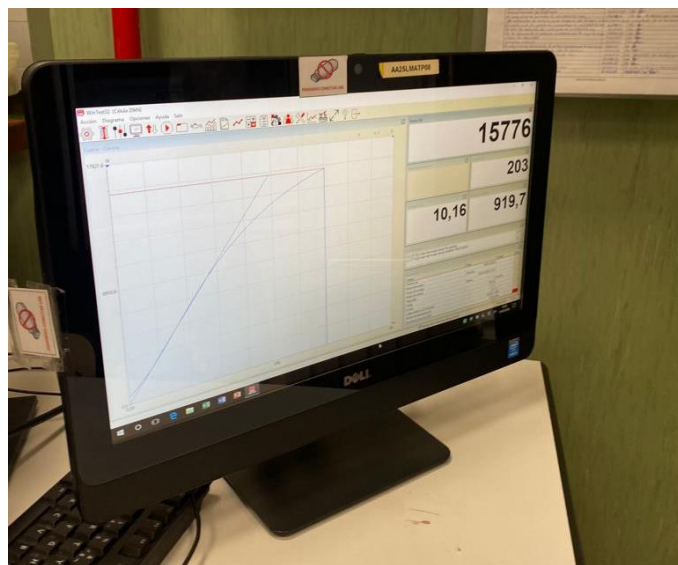
- Force: 2000N.
- Result: Failure due to improper curing.

**Test 2:**

- Force: 8000N.
- Result: Failure due to inadequate preparation.

**Test 3:**

- Force: 15700N.
- Success: Exceeded 10000N target.



*Figure 7: testing tube maximum force*

Proper curing and preparation are vital for optimal bond strength. Test 3 validates the process's reliability and strength.

## 5. Conclusions

The comprehensive design, fabrication, and testing of the adhesive bonding process for the IFS05 race car's suspension components have yielded substantial insights and achievements. The project's objectives were met with success, leading to key conclusions that highlight the significance of the endeavor:

- **Successful Bonding Process Validation:** Rigorous experimentation and testing validated the adhesive bonding process. Adhesive bond strength tests demonstrated the process's capability to withstand forces of up to 16000N, well beyond the targeted 10000N requirement. This success affirms the process's effectiveness in enhancing the bond strength between carbon-fiber tubes and aluminum inserts, ensuring suspension component integrity under varying loads.
- **Critical Surface Preparation:** Meticulous surface preparation emerged as a pivotal factor in achieving optimal adhesive bond strength. Effective grit-blasting and thorough sanding of both aluminum inserts and carbon-fiber tubes played a vital role in establishing a durable bond. Precise surface preparation ensures a clean, adhesive-ready substrate, mitigating the risk of bond failure due to contaminants or poor adhesion.
- **Adhesive Curing and Quality:** Adequate adhesive curing emerged as a crucial element in achieving desired bond strength. Early failures underscored the importance of proper curing, as inadequate curing led to weakened bonds. Optimizing the curing process and adhering to recommended times and conditions significantly increased bond strength, as demonstrated in the successful third test.
- **Iterative Design and Improvement:** The project's success exemplifies the value of iterative design and improvement. Initial test failures prompted a thorough analysis of bonding process parameters and identification of areas for enhancement. Subsequent adjustments, including optimized surface preparation and curing procedures, culminated in a successful adhesive bonding process that exceeded performance targets.
- **Collaborative Efforts:** The achievement of successful adhesive bonding owed much to collaborative teamwork. A multidisciplinary team contributed expertise in materials science, engineering, and fabrication. Collaborative synergy facilitated best practice implementation, efficient problem-solving, and productive knowledge exchange, contributing significantly to the overall project success.

In conclusion, this project establishes the development and validation of an adhesive bonding process for the IFS05 race car's suspension components. Emphasizing meticulous surface preparation, proper adhesive curing, and iterative design, the project achieved remarkable bond strength and reliability. These outcomes underscore the process's potential to enhance suspension system integrity and performance, showcasing advancements in materials science and engineering practices. The achievements not only elevate the Formula Student race car's performance but also contribute to the broader field of adhesive bonding applications in automotive engineering.

## **6. References**

- [1] W. D. & R. D. G. Callister, *Materials Science and Engineering: An Introduction* (10th ed.), 2018.
- [2] A. J. Kinloch, *Adhesion and Adhesives: Science and Technology*, 1997.
- [3] S. P. & G. J. N. Timoshenko, *Theory of Elasticity* (3rd ed.), 1970.



# FABRICACIÓN Y VALIDACIÓN DE LA SUSPENSIÓN DE UN FORMULA STUDENT

**Autor: Antonio Hernández-Ros Briales**

Director: Ignacio Granell Heredero

## RESUMEN DEL PROYECTO

**Palabras clave:** Unión adhesiva, Compuesto de fibra de carbono, Componentes de suspensión, Inserciones de aluminio, Proceso de fabricación, Resistencia de la unión, Preparación de superficies, Curado del adhesivo, Unión compuesto-aluminio, Pruebas mecánicas, Pruebas no destructivas, Optimización, Integridad estructural.

### 1. Introducción

En el mundo de la ingeniería de la competición, la búsqueda de un rendimiento óptimo y seguridad ha impulsado una innovación continua en el diseño de vehículos y componentes. A medida que el panorama automovilístico evoluciona, los materiales ligeros y las técnicas avanzadas de fabricación han cobrado protagonismo, ofreciendo el potencial para mejorar la dinámica y eficiencia de los vehículos. En este contexto, la integración de componentes de suspensión de fibra de carbono ha surgido como un área de enfoque crucial para mejorar el rendimiento de los autos de carreras. Esta tesis de maestría profundiza en el intrincado mundo del enlace adhesivo como un proceso fundamental en la fabricación de componentes de suspensión de fibra de carbono confiables y de alto rendimiento.



*Ilustración 1: IFS04*

Los compuestos de fibra de carbono son conocidos por su excepcional relación resistencia-precio y durabilidad, lo que los convierte en una elección ideal para mejorar la eficiencia del sistema de suspensión. La unión adhesiva desempeña un papel vital en la unión de diferentes materiales, como la fibra de carbono y el aluminio, al tiempo que mantiene la integridad estructural y reduce el peso. Esta tesis explora el desarrollo, prueba y optimización de un proceso de enlace adhesivo adaptado a las demandas únicas de los componentes de suspensión de fibra de carbono. Al lograr uniones sólidas, la tesis contribuye al avance del rendimiento y la seguridad de los vehículos de competición. [1]

El objetivo principal de este estudio es diseñar, desarrollar y validar un proceso de enlace adhesivo para componentes de suspensión de fibra de carbono. La investigación se centra en lograr una alta resistencia y durabilidad de la unión mientras se optimiza el proceso de fabricación. Los objetivos específicos incluyen:

- Investigar el estado del arte en técnicas de enlace adhesivo, unión de composite-aluminio y características de los materiales.
- Desarrollar un proceso de fabricación integral para preparar superficies, aplicar adhesivo y ensamblar componentes.
- Evaluar la resistencia y durabilidad de los componentes unidos por adhesivo mediante métodos de prueba destructiva y no destructiva.
- Analizar los resultados para evaluar la eficacia del proceso de enlace adhesivo y sus implicaciones para el rendimiento de la suspensión.

La implementación exitosa de un proceso de enlace adhesivo optimizado para componentes de suspensión de fibra de carbono tiene una gran importancia para la ingeniería del automovilismo. Los componentes de suspensión ligeros y resistentes impactan directamente en la maniobrabilidad del vehículo, su capacidad de respuesta y su rendimiento general en la pista. Además, esta investigación contribuye al campo más amplio de la integración de materiales compuestos en la industria automotriz.

El alcance de este estudio abarca todo el proceso de enlace adhesivo, desde la preparación de superficies hasta las pruebas, y tiene como objetivo abordar desafíos relacionados con la resistencia de la unión, la durabilidad y la fabricabilidad. Al presentar un marco integral para el enlace adhesivo, esta tesis dota a los ingenieros y diseñadores de conocimientos valiosos y metodologías para mejorar la calidad y el rendimiento de los sistemas de suspensión.

En las secciones siguientes, esta tesis detalla los objetivos de la investigación, explora el estado del arte en técnicas de enlace adhesivo, presenta el proceso de fabricación y pruebas de suspensión, discute las conclusiones extraídas de la investigación y proporciona una lista de referencias para una exploración más profunda.



*Ilustración 2: explosionado del brazo de la suspensión*

## 2. Objetivos

La fase actual de investigación está dedicada a la exploración meticulosa, análisis y perfeccionamiento del proceso de fabricación y los protocolos de prueba para tubos de fibra de carbono integrados con insertos de aluminio, utilizando adhesivo epoxi estructural. El objetivo principal es lograr una comprensión exhaustiva de las complejidades de fabricación y los atributos de rendimiento de estos tubos compuestos. Con este fin, se ha delineado un conjunto de objetivos específicos para orientar este esfuerzo de investigación:

### **Optimización del Proceso de Fabricación:**

- ✓ Desarrollar un proceso de fabricación detallado y minucioso para la creación de tubos de fibra de carbono con insertos de aluminio integrados de manera fluida.
- ✓ Explorar un espectro de metodologías de fabricación que abarquen técnicas de soldadura, unión y capas, culminando en la identificación del enfoque más pertinente.
- ✓ Profundizar en la mejora del proceso de infusión de resina para garantizar la dispersión uniforme y equitativa del adhesivo epoxi dentro de la estructura compuesta.
- ✓ Adentrarse en las complejidades del proceso de curado para comprender las características mecánicas precisas y la capacidad de unión adhesiva previstas.

### **Selección y Caracterización de Materiales:**

- ✓ Realizar una caracterización completa de los materiales de fibra de carbono, desvelando sus atributos mecánicos, incluida la resistencia a la tracción, rigidez y resistencia a la fatiga.
- ✓ Evaluar una variedad diversa de insertos de aluminio y, en última instancia, elegir una aleación adecuada que armonice con las características del material del compuesto.
- ✓ Realizar pruebas de compatibilidad, examinando críticamente la dinámica de unión adhesiva entre la fibra de carbono, el adhesivo epoxi y los insertos de aluminio.

### **Aplicación de Adhesivo y Unión:**

- ✓ Determinar la formulación esencial del adhesivo epoxi que efectivamente propicia una unión robusta y duradera entre el tubo de fibra de carbono y el inserto de aluminio.
- ✓ Diseñar una serie óptima de metodologías de preparación de superficies que otorguen una tenacidad de unión adhesiva elevada.

- ✓ Asegurar con precisión los parámetros de curado del adhesivo, abarcando temperatura, presión y duración del curado, para infundir confiabilidad y consistencia en el proceso de unión.

### **Integridad Estructural y Rendimiento Mecánico:**

- ✓ Realizar un análisis estructural incisivo para evaluar la capacidad de carga y la distribución intrincada de tensiones en todo el tubo de fibra de carbono con el inserto de aluminio integrado.
- ✓ Examinar el umbral de resistencia del compuesto bajo los escenarios de carga más exigentes.
- ✓ Llevar a cabo una serie de pruebas exhaustivas diseñadas para identificar el límite de resistencia del compuesto y analizar su durabilidad perdurable.
- ✓ Descubrir las repercusiones de las influencias ambientales como la temperatura y la humedad en la unión adhesiva y el comportamiento general del compuesto.

### **Evaluación No Destructiva:**

- ✓ Establecer un protocolo de pruebas completo meticulosamente diseñado para descubrir con confianza defectos y aberraciones ocultos dentro de la estructura compuesta.

### **Optimización y Validación:**

- ✓ Iniciar un proceso iterativo cíclico que revolucione el proceso de fabricación y las técnicas de aplicación de adhesivo, aprovechando las ideas obtenidas de las pruebas y la caracterización minuciosa.
- ✓ Validar el epítome del proceso de fabricación optimizado y la técnica de unión adhesiva a través de una variedad de pruebas mecánicas y de durabilidad repetitivas.
- ✓ Llevar a cabo una comparación exhaustiva de los resultados de las pruebas con las proyecciones analíticas previstas, solidificando en última instancia la precisión y veracidad de los paradigmas de fabricación y pruebas.

Este es el resultado de estos objetivos de la ciencia de los materiales compuestos y las metodologías de fabricación. Estos logros enriquecerán significativamente el corpus de conocimiento sobre el diseño y la mejora del rendimiento de estructuras compuestas con insertos de aluminio, perpetuando su avance para el ISC Racing Team.

### 3. Estado del arte

#### Unión adhesiva

La unión adhesiva es esencial para unir materiales diferentes, como compuestos y aluminio. Esta sección describe técnicas avanzadas para la unión de compuestos y aluminio, y profundiza en diversos tipos de adhesivos. [2]

- **Unión de compuestos y aluminio**

Lograr una unión duradera entre compuestos y aluminio exige una preparación efectiva de la superficie, selección de adhesivos y métodos de unión adecuados. Promotores de adhesión y métodos como la superposición húmeda, adhesivos en película y adhesivos en pasta mejoran la calidad de la unión.

- **Adhesivos generales y métodos de unión**

Los adhesivos se utilizan en diversas industrias. Los adhesivos cianoacrilatos curan al instante, los adhesivos de poliuretano ofrecen flexibilidad, los adhesivos acrílicos destacan en aplicaciones ópticas, los adhesivos anaeróbicos curan sin aire y los adhesivos curables con luz ultravioleta curan rápidamente.

#### Pruebas mecánicas

- **Pruebas destructivas**

Las pruebas de pelado y corte evalúan la resistencia de la unión. La documentación registra los detalles de la prueba, el equipo, los parámetros y las observaciones. [3]

- Pruebas de pelado

Las pruebas de pelado miden la resistencia de la unión mediante separación controlada. La documentación incluye detalles de la prueba, equipo y observaciones.

- Pruebas de corte

Las pruebas de corte evalúan el impacto de las fuerzas laterales en el adhesivo. La documentación registra los detalles de la prueba, el equipo, los parámetros y las observaciones.

- Examen con Microscopía

La microscopía examina las superficies de compuestos y aluminio separadas. La documentación incluye detalles de la prueba, equipo y observaciones.

- **Pruebas no destructivas**

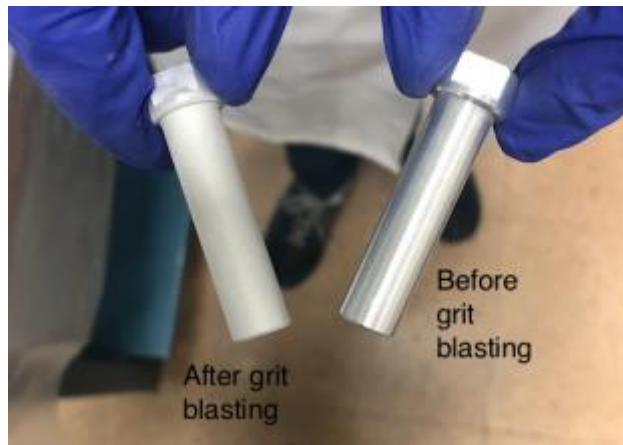
Las pruebas no destructivas verifican la calidad de la unión sin comprometer los componentes. La inspección visual, pruebas ultrasónicas, serigrafía y termografía garantizan la confiabilidad.

#### 4. Fabricación y ensayos de la suspensión

- **Fabricación de la suspensión**

##### **Preparación de inserciones y tubos para unión:**

- Paso 1: Activar el compresor
- Paso 2: Preparación del equipo de granallado
- Paso 3: Granallado de las inserciones
- Paso 4: Procedimientos posteriores al granallado



*Ilustración 3: granallado de los insertos*

##### **Preparación de tubos de fibra de carbono:**

- Paso 1: Lijado de los bordes del tubo
- Paso 2: Lijado del interior
- Paso 3: Limpieza y secado



*Ilustración 4: lijado de los tubos de fibra*

### **Unión adhesiva:**

- Paso 1: Configuración de la pistola de cartuchos de adhesivo
- Paso 2: Aplicación del adhesivo
- Paso 3: Repetir para el otro lado
- Paso 4: Verificación de la alineación



*Ilustración 5: pegado de los insertos*

### **Limpieza:**

- Paso 1: Mantenimiento del cartucho de adhesivo
- Paso 2: Limpieza general

- **Ensayos de la suspensión**

### **Pruebas de resistencia de la unión adhesiva:**

- Paso 1: Preparación del espécimen
- Paso 2: Configuración de la prueba
- Paso 3: Inicialización y calibración
- Paso 4: Realización de la prueba
- Paso 5: Recopilación de datos
- Paso 6: Análisis y resultado
- Paso 7: Interpretación
- Paso 8: Documentación



*Ilustración 6: probetas de ensayo*

- **Resultados:**

**Prueba 1:**

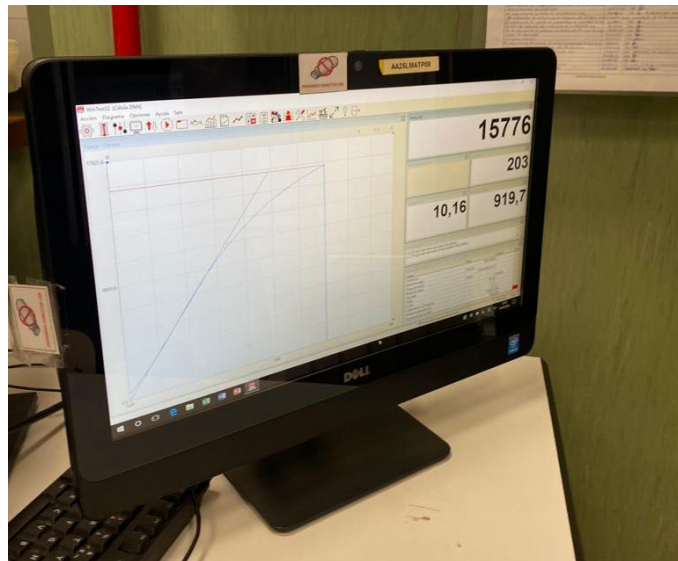
- Fuerza: 2000N.
- Resultado: Fallo debido al curado inadecuado.

**Prueba 2:**

- Fuerza: 8000N.
- Resultado: Fallo debido a preparación insuficiente.

**Prueba 3:**

- Fuerza: 15700N.
- Éxito: Superó el objetivo de 10000N.



*Ilustración 7: fuerza máxima del adhesivo*

El curado y la preparación adecuados son esenciales para una resistencia óptima de la unión. La prueba 3 valida la confiabilidad y la resistencia del proceso.



## 5. Conclusiones

El diseño, fabricación y pruebas integrales del proceso de unión adhesiva para los componentes de suspensión del automóvil de carreras IFS05 han arrojado importantes conocimientos y logros. Los objetivos del proyecto se han cumplido con éxito, lo que lleva a conclusiones clave que resaltan la importancia de este esfuerzo:

- **Validación Exitosa del Proceso de Unión:** Experimentación rigurosa y pruebas validaron el proceso de unión adhesiva. Las pruebas de resistencia de la unión adhesiva demostraron que el proceso puede soportar fuerzas de hasta 16000N, mucho más allá del requisito objetivo de 10000N. Este éxito confirma la efectividad del proceso en mejorar la resistencia de la unión entre los tubos de fibra de carbono y las inserciones de aluminio, asegurando la integridad de los componentes de suspensión bajo diversas cargas.
- **Preparación de Superficies Crucial:** La meticulosa preparación de superficies emergió como un factor crucial para lograr una resistencia óptima de la unión adhesiva. El granallado efectivo y el lijado minucioso tanto de las inserciones de aluminio como de los tubos de fibra de carbono desempeñaron un papel vital en el establecimiento de una unión duradera. La preparación precisa de las superficies asegura un sustrato limpio y listo para la adhesión, mitigando el riesgo de falla de la unión debido a contaminantes o mala adherencia.
- **Curado y Calidad del Adhesivo:** El curado adecuado del adhesivo emergió como un elemento crucial para lograr la resistencia deseada de la unión adhesiva. Los fallos iniciales subrayaron la importancia del curado correcto, ya que un curado inadecuado debilitó las uniones. La optimización del proceso de curado y el cumplimiento de los tiempos y condiciones recomendados aumentaron significativamente la resistencia de la unión, como se demostró en la exitosa tercera prueba.
- **Diseño Iterativo y Mejora:** El éxito del proyecto ejemplifica el valor del diseño iterativo y la mejora continua. Los fallos iniciales en las pruebas llevaron a un análisis exhaustivo de los parámetros del proceso de unión y la identificación de áreas de mejora. Ajustes posteriores, incluida la preparación de superficies optimizada y los procedimientos de curado, culminaron en un proceso de unión adhesiva exitoso que superó los objetivos de rendimiento.
- **Esfuerzos de Colaboración:** El logro de la unión adhesiva exitosa se debe en gran parte al trabajo en equipo colaborativo. Un equipo multidisciplinario contribuyó con experiencia en ciencia de materiales, ingeniería y fabricación. La sinergia colaborativa facilitó la implementación de las mejores prácticas, la resolución eficiente de problemas y el intercambio productivo de conocimientos, lo que contribuyó significativamente al éxito general del proyecto.

En conclusión, este proyecto establece el desarrollo y la validación de un proceso de unión adhesiva para los componentes de suspensión del automóvil de carreras IFS05. Al enfatizar la preparación meticulosa de superficies, el curado adecuado del adhesivo y el diseño iterativo, el proyecto logró una resistencia y confiabilidad de la unión adhesiva notable. Estos resultados resaltan el potencial del proceso para mejorar la integridad y el rendimiento del sistema de suspensión, demostrando avances en la ciencia de materiales

y las prácticas de ingeniería. Los logros no solo elevan el rendimiento del automóvil de carreras Formula Student, sino que también contribuyen al campo más amplio de las aplicaciones de unión adhesiva en la ingeniería de automoción.

## **6. Referencias**

- [1] W. D. & R. D. G. Callister, *Materials Science and Engineering: An Introduction* (10th ed.), 2018.
- [2] A. J. Kinloch, *Adhesion and Adhesives: Science and Technology*, 1997.
- [3] S. P. & G. J. N. Timoshenko, *Theory of Elasticity* (3rd ed.), 1970.

# Contents

<b>Chapter 1. Introduction.....</b>	<b>5</b>
1.1 Formula Student .....	5
1.2 Motivation .....	9
1.3 The IFS04 and IFS05 .....	12
1.4 Objectives.....	14
1.5 Working methodology.....	17
1.6 Resources .....	18
<b>Chapter 2. State of art.....</b>	<b>20</b>
2.1 Adhesive bonding.....	20
2.1.1 Composite-Aluminium Bonding.....	20
2.1.2 General Adhesives and Bonding Methods.....	21
2.2 Mechanical tests .....	22
2.2.1 Destructive testing.....	22
2.2.2 Non-destructive testing.....	26
<b>Chapter 3. Suspension manufacture and testing.....</b>	<b>30</b>
3.1 Suspension manufacture.....	30
3.1.1 Surface Treatment for Inserts.....	30
3.1.2 Surface Preparation of Carbon-Fiber Tubes .....	32
3.1.3 Bonding Adhesive to Inserts and Carbon-Fiber Tubes .....	33
3.1.4 Cleanup .....	35
3.2 Suspension testing .....	36
3.2.1 Adhesive Bond Strength Testing Procedure .....	36
3.2.2 Results .....	39
<b>Chapter 4. Conclusion and future work .....</b>	<b>42</b>
4.1 Conclusions .....	42
4.2 Future work .....	44

<i>Chapter 5. Bibliography .....</i>	<i>47</i>
<i>ANNEX I – Alignment of Project with SDGs.....</i>	<i>50</i>
<i>ANNEX II – Final results .....</i>	<i>52</i>

## *List of Figures*

Figure 1: IFS 04.....	7
Figure 2: suspension arm exploded .....	8
Figure 3: inserts blasting .....	12
Figure 4: carbon fiber sanding.....	12
Figure 5: adhesive bonding .....	13
Figure 6: suspension testing tube .....	14
Figure 7: testing tube maximum force.....	14
Figure 8: Formula Student Italy 2022 .....	6
Figure 9: IFS04 during the autocross test.....	8
Figure 10: Me with some of the Dynamics & Suspension team members.....	11
Figure 11: IFS04 during the autocross test.....	12
Figure 12: Detail of the front suspension of the IFS04 .....	13
Figure 13: suspension arm exploded .....	14
Figure 14: peel testing .....	23
Figure 15: shear testing .....	24
Figure 16: microscopy .....	25
Figure 17: ultrasonic inspection .....	27
Figure 18: shearography .....	28
Figure 19: Thermography.....	29
Figure 20: surface treatment for inserts.....	31
Figure 21: surface preparation carbon tubes.....	33
Figure 22: bonding process .....	34
Figure 23: bonding results .....	35
Figure 24: special insert for testing.....	36
Figure 25: suspension test bar .....	38
Figure 26: suspension test bar after failure.....	39
Figure 27: maximum force adhesive .....	41
Figure 28: SDGs of the master's thesis.....	51

---

Figure 29: Suspension render .....	52
Figure 30: Suspension top view.....	53
Figure 31: Rear suspension front view .....	54
Figure 32: Front suspension front view .....	54
Figure 33: Suspension soldering.....	55
Figure 34: rear suspension soldering .....	56
Figure 35: Suspension final assembly .....	57

## *List of Tables*

Table 1: Formula Student Scoring points .....	9
---	---

## **Chapter 1. INTRODUCTION**

### ***1.1 FORMULA STUDENT***

Formula Student, also known as Formula SAE, is a renowned international university competition that originated in the United States in the 1980s. Over the years, it has grown exponentially to become one of the largest and most prestigious competitions of its kind worldwide. Each year, thousands of students from universities around the globe come together to participate in the multiple events organized as part of Formula Student. [4]

The heart of Formula Student lies in the construction and development of a single-seater, formula-style racing car by student teams. This multidisciplinary project combines various aspects of engineering, business, and motorsport. Participants are responsible for managing every facet of the project, including business planning, marketing, team management, procurement and sponsorships, component design, manufacturing and assembly, data analysis, logistics, and more. The holistic approach ensures that students gain valuable hands-on experience in all aspects of a real-world engineering project.

The competitions within Formula Student serve as a platform for students to apply their engineering knowledge and skills in a competitive environment. It challenges them to push the boundaries of innovation, design, and performance while adhering to strict technical regulations. The events consist of dynamic challenges, such as acceleration, skid pad, autocross, and endurance races, as well as static events like design presentation, cost analysis, and business plan presentation. Each competition evaluates the performance of the teams, their ability to innovate, and their overall understanding of engineering principles.

Participating in Formula Student offers students numerous benefits beyond technical expertise. It fosters the development of essential skills such as teamwork, project

management, problem-solving, and effective communication. The competition also provides a unique networking opportunity, allowing students to interact with industry professionals, potential employers, and other like-minded individuals from the automotive and motorsport industries. [5]

Furthermore, Formula Student serves as a catalyst for innovation in automotive engineering. It encourages students to explore new technologies, lightweight materials, energy-efficient designs, and advanced manufacturing techniques. Many groundbreaking ideas and concepts in the automotive industry have originated from Formula Student projects, demonstrating its significant impact on the field.



*Figure 8: Formula Student Italy 2022*



It consists in the following events, including statics and dynamic tests:

**Engineering design:** During the engineering design phase, teams are required to present their car's design to the judges. The presentation focuses on justifying the chosen design over other alternatives, emphasizing the meticulous analysis and development that went into each decision. This includes considerations of aerodynamics, weight distribution, suspension geometry, and overall performance. Judges assess the teams' ability to articulate their design choices and demonstrate a comprehensive understanding of engineering principles.

**Cost & Manufacturing:** Teams must provide a detailed report outlining the costs associated with the project and the manufacturing processes for each component. This report is thoroughly evaluated by judges, who scrutinize the accuracy of cost estimations and the teams' comprehension of manufacturing techniques. Demonstrating cost-effective solutions and efficient manufacturing strategies contributes to the overall evaluation of the team's practicality and resource management skills.

**Business plan:** The business plan event simulates a pitch to potential investors. Judges evaluate the quality of the presentation, assessing the team's ability to communicate their project's vision, market potential, and financial viability. Originality, feasibility, and an understanding of market dynamics are key factors in this evaluation. A well-crafted business plan demonstrates the team's entrepreneurial mindset and strategic thinking.

**Acceleration:** The acceleration event tests the car's ability to achieve rapid acceleration in a straight 75-meter track. Factors such as powertrain performance, traction, and weight distribution play a crucial role in this event. Judges evaluate the teams based on the car's acceleration times, which reflect their engineering prowess in optimizing power-to-weight ratios and maximizing overall performance.

**Skidpad:** Teams must navigate a figure-eight-shaped circular track known as the skidpad. This event emphasizes the car's performance in steady-state cornering. This test assesses the

car's lateral grip, handling, and stability, evaluating the team's ability to design an effective suspension system, select appropriate tires, and optimize vehicle dynamics for improved cornering.

**Autocross:** The autocross event challenges teams to achieve the fastest lap time on a cone-marked circuit. It assesses the car's overall handling, responsiveness, and agility. The autocross evaluates the teams based on their driving skill, car control, and the ability to set up the vehicle for optimal performance. The times achieved in this event determine the starting order for the Endurance race.

**Endurance:** The endurance event is the pinnacle of the competition and showcases the car's reliability and efficiency. Teams must complete a grueling 22-kilometer race, where endurance and fuel efficiency are critical factors. It assesses the teams based on their ability to finish the race and the car's overall performance under demanding conditions.



*Figure 9: IFS04 during the autocross test*

These events in Formula Student encompass a wide range of engineering disciplines, including mechanical design, aerodynamics, vehicle dynamics, cost analysis, and business planning. They provide a comprehensive evaluation of the teams' engineering capabilities, innovation, practicality, and ability to execute a successful project, being the winner of the competition the team that scores the most points overall in all disciplines.

Event Points Distribution	
Engineering Design	150 - 200 points
Cost & Manufacturing	100 - 150 points
Business Plan	75 - 100 points
Acceleration	75 - 100 points
Skidpad	50 - 75 points
Autocross	100 - 125 points
Endurance	300 - 400 points

*Table 1: Formula Student Scoring points*

## **1.2** *MOTIVATION*

Ever since I can remember, I have been captivated by the world of motorsports, particularly high-performance racing. My lifelong dedication to following Formula 1 led me to pursue an engineering career with the ultimate goal of designing and manufacturing cars.

During my university years, I had the privilege of participating in the Formula Student project, a competition where students from around the globe design and construct their own formula-style racing cars for inter-university challenges. Over the past three years, I have embraced the Formula Student experience, taking on the responsibility of leading the Dynamics and Suspension department. Witnessing the team's growth and relentless pursuit of knowledge throughout the project has been incredibly rewarding.

As I am close to the completion of my engineering studies, I am thrilled to seize the opportunity to focus my master's thesis on the realm that truly ignites my passion, the world of racing, specifically with the ISC Formula Student Racing Team. This team has become

an integral part of my journey, and the countless hours invested in its success have brought me immense joy.

My thesis serves as a conduit to merge my ardour for motorsports with my engineering expertise, empowering me to contribute to the advancement and optimization of race car performance. I am grateful for the chance to further expand my comprehension of the intricacies within racing engineering and to make a meaningful impact in the field.

I am eagerly prepared to embark on this new chapter, leveraging the knowledge and skills acquired throughout my academic pursuits and practical experiences within the Formula Student project. It is my aspiration that this research will not only propel my personal growth but also catalyse positive transformations within the racing industry.

I express deep gratitude for the unwavering support and opportunities provided by both the university and the ISC Formula Student Racing Team. They have been pivotal in shaping my career aspirations and nurturing my passion for motorsports. Anticipating the challenges and rewards that lie ahead, I eagerly embrace the journey of delving deeper into the realm of racing engineering, striving to leave an indelible mark on this exhilarating and ever-evolving field.

The 2022/2023 season presented significant challenges for the suspension systems of our Formula Student car. The existing design exhibited various issues stemming from the project's early stages, demanding a fresh approach to enhance competitiveness.

Driven by the desire to overcome these hurdles, I embarked on my master's thesis project to document the process of designing a new suspension system that could effectively address the car's problems. Leading the department added to my responsibility, compelling me to complete the project within a year to participate in Formula Student competitions and showcase the extensive behind-the-scenes work.

Moreover, the suspension of a race car holds relevance beyond the Formula Student realm and finds practical application in the broader automotive industry. The knowledge and skills gained from researching and designing a Formula Student suspension have the potential to be transferable to projects and positions in the field of high-performance vehicles and engineering.

Through meticulous documentation and comprehensive analysis of the challenges faced during the suspension design process, my aim is to contribute not only to the success of our Formula Student team but also to the advancement of suspension design practices in the automotive industry at large. By addressing the shortcomings of our current system and exploring innovative solutions, I hope to make a meaningful impact on the future of suspension technology.



*Figure 10: Me with some of the Dynamics & Suspension team members*

### **1.3 THE IFS04 AND IFS05**

The IFS04, the fourth concept car of the ISC Formula Student Racing Team, served as an upgrade to the IFS03 for the 2021/2022 season. It participated in Formula Student Italy and Formula Student Spain, becoming the first prototype to pass technical inspections and successfully complete dynamic tests.



*Figure 11: IFS04 during the autocross test*

During track testing, it became apparent that the car had several dynamic issues, primarily related to the suspension system. Manoeuvrability was a significant concern, as the car struggled to navigate tight turns and lacked agility when required. Additionally, the geometry of the tires was inconsistent with wheel travel, resulting in suboptimal tire contact patches.

Excessive pitch was another challenge, leading to impacts on the front wing during braking manoeuvres. Recognizing the need for improvement, the team decided to focus on enhancing the suspension system for the IFS05, the prototype for the 2022/2023 season.

The IFS05 represents a substantial improvement over the IFS04, with a strong emphasis on car performance and functionality. The goal of this new project is to address the mechanical and electrical issues encountered during previous competitions.

To ensure a successful season, the team meticulously planned and defined objectives for each department, aiming to overcome challenges, optimize performance, and achieve their desired goals.



*Figure 12: Detail of the front suspension of the IFS04*

## **1.4 OBJECTIVES**

The primary objective of this phase of the research is to investigate, analyse, and optimize the manufacturing process and testing procedures for carbon fiber tubes with integrated aluminium inserts, utilizing structural epoxy adhesive. This phase aims to achieve a comprehensive understanding of the fabrication and performance characteristics of these composite tubes. The following specific objectives will guide this research:



*Figure 13: suspension arm exploded*

### **Manufacturing Process Optimization:**

- ✓ Develop a detailed manufacturing process for fabricating carbon fiber tubes with aluminium inserts.
- ✓ Investigate various fabrication techniques, including soldering, bonding, and lay-up methods, to determine the most suitable approach.
- ✓ Optimize the resin infusion process to ensure uniform distribution of the epoxy adhesive within the composite structure.



- ✓ Study the curing process to achieve the desired mechanical properties and adhesive bonding strength.

**Material Selection and Characterization:**

- ✓ Conduct a comprehensive characterization of carbon fiber materials to determine their mechanical properties, including tensile strength, stiffness, and fatigue resistance.
- ✓ Evaluate different types of aluminium inserts and select an appropriate alloy that complements the composite material properties.
- ✓ Perform compatibility tests to assess the bonding characteristics between the carbon fiber, epoxy adhesive, and aluminium insert.

**Adhesive Application and Bonding:**

- ✓ Investigate the most suitable epoxy adhesive formulation for achieving a strong and durable bond between the carbon fiber tube and aluminium insert.
- ✓ Develop optimized surface preparation methods to enhance adhesive bonding strength.
- ✓ Establish adhesive curing parameters, including temperature, pressure, and curing time, to achieve consistent and reliable bonds.

**Structural Integrity and Mechanical Performance:**

- ✓ Conduct structural analysis to assess the load-carrying capacity and stress distribution of the carbon fiber tube with integrated aluminium insert.
- ✓ Investigate the resistance of the carbon fiber tube with aluminium insert under maximum loading conditions.
- ✓ Perform tests to determine the composite's endurance limit and evaluate its long-term durability.

- ✓ Analyse the effects of environmental factors, such as temperature and humidity, on the adhesive bond and composite behaviour.

**Non-Destructive Evaluation:**

- ✓ Develop a comprehensive testing protocol to ensure reliable detection of flaws and defects within the composite structure.

**Optimization and Validation:**

- ✓ Iterate the manufacturing process and adhesive application techniques based on insights gained from testing and characterization.
- ✓ Validate the optimized manufacturing process and adhesive bonding through repeated mechanical and durability tests.
- ✓ Compare the test results with analytical predictions to verify the accuracy of the fabrication and testing methods.

The successful accomplishment of these objectives will contribute to the advancement of knowledge in the field of composite materials and their manufacturing processes. It will also provide valuable insights for enhancing the design and performance of carbon fiber-reinforced composite structures with integrated aluminium inserts.

## ***1.5 WORKING METHODOLOGY***

The working methodology in this master's thesis project aligns with the needs and timelines of the Formula Student team, which follows well-defined stages of design, manufacturing, and on-track validation to ensure the timely preparation of the car for competitions.

1. **Conceptual Design:** During this stage, the suspension design objectives and requirements for the Formula Student car are conceptualized and defined. Different configurations are explored, and preliminary evaluations of each conceptual design are conducted. Building upon the previous car, the most significant changes to be implemented in the new season are determined.
2. **Planning:** In this phase, a detailed work plan is established, including deadlines, required resources, and specific activities. The work sequence is determined, and responsibilities are assigned to team members. Possible risks are identified, and strategies for risk mitigation are developed.
3. **Design Phase:** This stage involves the detailed design of the suspension. Computer-aided design (CAD) tools are utilized to create 3D virtual models of the suspension components and their assembly. Dimensions, materials, and manufacturing methods for each component are defined. Additionally, finite element analysis (FEA) is conducted to assess the structural performance and strength of the components.
4. **Validation and Optimization Phase:** During this stage, the proposed suspension design is validated and optimized. Virtual tests and simulations are performed to evaluate the performance of the suspension under different loading and handling conditions. The results obtained from these tests are used to make adjustments and improvements to the initial design.

5. **Manufacturing and Assembly Phase:** Once the suspension design is validated and optimized, the manufacturing of the suspension components begins. Appropriate materials are selected, and manufacturing techniques such as machining or adhesive methods are employed to produce the components according to specifications. The suspension is then assembled on the vehicle, ensuring proper installation and adjustment of all components.

It is essential to note that these stages may vary depending on the specific focus and objectives of the Formula Student suspension thesis. Adapting the methodology to the project's requirements and having the support of the project supervisor are crucial for ensuring the quality and success of the work.

## **1.6 RESOURCES**

The resources to be utilized for the completion of the master's Thesis Project are as follows:

- **Excel:** A spreadsheet program developed by Microsoft, primarily employed in tasks related to numerical data analysis and management. It serves as a valuable tool for efficiently organizing, manipulating, analysing, and visualizing data. In engineering, such as in this case, Excel is utilized to streamline calculations, as seen in force computations for suspension elements.
- **SolidWorks:** Widely used CAD software in the industry, facilitating the design of intricate parts and assemblies. SolidWorks will be employed to design suspension components, their assemblies, and the associated drawings.
- **Ansys:** A multi-physics CAE simulation software for finite element analysis of systems. Critical suspension components will be validated using Ansys to ensure their structural integrity and optimize their properties.

- **Materials and Suppliers:** Carbon fiber tubes, epoxy adhesive, aluminium parts, and all necessary resources for manufacturing supplied by vendors are indispensable for project development.
- **Materials Laboratory:** Equipped with specialized instruments and equipment for conducting tests and analyses of various material properties and behaviours. The lab will be utilized for surface preparation for adhesive bonding, adhesive application, and curing, as well as conducting tensile tests on the composite bars.
- **Testing Machine:** A testing machine employed to apply controlled forces and measure mechanical responses of materials. In the context of suspension manufacturing and testing, this machine will conduct tensile tests on the bonded carbon fiber tubes and other suspension components. The machine will gradually apply increasing force to the component, measuring deformation and material strength. These tests will verify bonding quality and joint strength, ensuring suspension structural integrity.
- **Sponsors and Subcontractors:** Within the realm of component manufacturing, support from sponsors provides financial and logistical assistance. Additionally, subcontractors manage the production of complex components, including machining and welding.

Collectively, these resources will contribute to the successful execution of the Master's Thesis Project, allowing for comprehensive investigation, design, manufacturing, and testing of carbon fiber tubes with aluminium inserts bonded using structural epoxy adhesive. The integration of these resources will ensure the validity, reliability, and accuracy of the project's outcomes.

## **Chapter 2. STATE OF ART**

### **2.1 ADHESIVE BONDING**

Adhesive bonding plays a crucial role in joining dissimilar materials, such as composites and aluminium, in various engineering applications. This section provides an overview of the current state of the art in adhesive bonding techniques for composite-aluminium joints, as well as an insight into general adhesive types and bonding methods. [6]

#### **2.1.1 COMPOSITE-ALUMINIUM BONDING**

The bonding of composite materials to aluminium substrates poses unique challenges due to their differing properties and behaviour under loads. Achieving a durable and robust bond between these dissimilar materials requires careful selection of adhesives and appropriate surface treatments. [5]

- **Surface Preparation:** The success of adhesive bonding hinges on effective surface preparation. For aluminium, this involves removing oxide layers and ensuring a clean, roughened surface. Composite surfaces may require treatments such as abrasion, chemical etching, or plasma treatment to enhance adhesion.
- **Adhesive Selection:** Choosing the right adhesive is pivotal. Epoxy-based structural adhesives are commonly used due to their excellent adhesion properties and compatibility with both composites and aluminium. Toughened epoxy adhesives provide improved durability and impact resistance.
- **Adhesion Promoters:** In some cases, using adhesion promoters can enhance the bond strength by creating a chemical link between the adhesive and the substrate. Silane coupling agents are commonly employed to improve adhesion between aluminium and composites.

- **Bonding Methods:** Composite-aluminium joints can be bonded using various methods, including: [6]
  - **Wet Layup:** Applying adhesive onto the substrate and placing the composite material onto it, followed by curing. This method allows precise adhesive application and is suitable for complex shapes.
  - **Film Adhesives:** Pre-cured adhesive films are applied between the composite and aluminium surfaces. This method is suitable for large-scale production but may require controlled heat and pressure.
  - **Paste Adhesives:** Adhesive paste is applied to one or both substrates, followed by assembly. This method provides ease of application and is suited for irregular surfaces.

### **2.1.2 GENERAL ADHESIVES AND BONDING METHODS**

Beyond composite-aluminium bonding, adhesives find broad applications in various industries. Different types of adhesives offer unique properties for specific use cases: [6]

- **Cyanoacrylate Adhesives:** Instant adhesives that cure quickly. They are suitable for bonding small parts and are commonly used in consumer electronics.
- **Polyurethane Adhesives:** Flexible and impact-resistant, these adhesives are used in applications where substrates may undergo movement or stress.
- **Acrylic Adhesives:** Providing excellent clarity and resistance to UV, these adhesives are used in optical applications and structural bonding.
- **Anaerobic Adhesives:** Curing in the absence of air, these adhesives are often used for thread locking and sealing applications.

- **UV-Curable Adhesives:** Rapidly curing when exposed to ultraviolet light, these adhesives are used in applications where quick curing is essential.

Adhesive bonding techniques have evolved to meet the demands of joining dissimilar materials like composites and aluminium. Understanding the complexities of composite-aluminium bonding and the variety of adhesive types and methods available is essential for successful engineering applications. Advances in adhesive technology continue to expand the possibilities for strong, reliable, and durable bonds in various industries.

## **2.2**     *MECHANICAL TESTS*

### **2.2.1**   *DESTRUCTIVE TESTING*

In the pursuit of ensuring the integrity of the adhesive bonding process, destructive testing methods are employed to comprehensively evaluate the correctness and quality of composite-aluminium joints. The following section outlines the procedures and documentation involved in utilizing these destructive testing techniques. [7]

#### **2.2.1.1**   *Peel Testing*

To assess the bond strength and adhesion quality between the composite and aluminium layers through controlled separation.

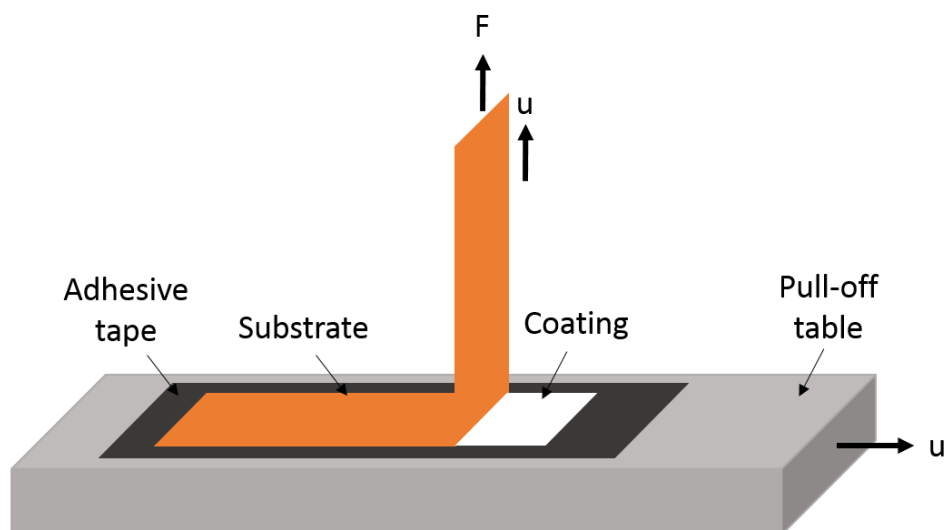
1. Preparation: Prepare bonded specimens with standardized dimensions, ensuring representative bonding conditions.
2. Testing Apparatus: Utilize a universal testing machine equipped with appropriate grips and fixtures for securing the composite-aluminium specimen.
3. Test Execution: Secure the specimen in the grips, ensuring uniform contact across the bonded interface. Gradually apply tensile force until separation occurs.



4. Data Collection: Record the maximum force required for separation. Note any anomalies, such as abrupt failures or irregular force profiles.

Documentation:

- Test Date and Time: Record the exact date and time of the test execution.
- Specimen Information: Document details of the specimen, including dimensions, materials used, and bonding area.
- Testing Equipment: Specify the make and model of the universal testing machine and grips used.
- Test Parameters: Record the applied force rate, and any relevant testing standards followed.
- Observations: Document any observations made during the test, such as audible cues, irregularities in force profiles, or visual changes at the bonded interface.



*Figure 14: peel testing*

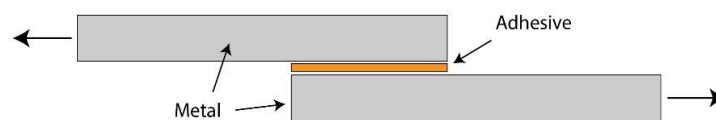
### **2.2.1.2 Shear Testing**

To evaluate the adhesive's resistance to lateral forces by inducing controlled sliding stresses along the composite-aluminium bond line.

1. **Sample Preparation:** Fabricate specimens with suitable dimensions, ensuring consistent adhesive coverage.
2. **Test Configuration:** Secure the specimen in the shear testing fixture, aligning the shear plane parallel to the bonded interface.
3. **Loading Application:** Gradually apply lateral force until the bonded layers begin to slide against each other.
4. **Data Collection:** Record the maximum force sustained during sliding. Note any anomalies in force-displacement curves.

Documentation:

- **Test Date and Time:** Document the exact date and time of the shear test.
- **Specimen Details:** Specify specimen dimensions, materials, and bonding area.
- **Testing Apparatus:** Provide information about the shear testing fixture used.
- **Test Parameters:** Include the applied force rate and adherence to relevant testing standards.
- **Observations:** Detail any observations made during the test, such as the initiation of sliding, force variations, or abrupt failures.



Lap Shear Configuration

*Figure 15: shear testing*

### 2.2.1.3 Microscopy Examination

To visually assess the bonded interface for irregularities, voids, or incomplete bonding after destructive testing.

1. Sample Preparation: After performing peel or shear tests, carefully separate the composite and aluminium layers.
2. Microscopic Analysis: Use optical or scanning electron microscopy to examine the separated surfaces of both materials.

Documentation:

- Microscopy Date and Time: Record the date and time of microscopy analysis.
- Microscopy Equipment: Specify the microscopy equipment and settings used.
- Observations: Document any findings, such as voids, irregularities, or signs of incomplete bonding observed in the microscopic images.

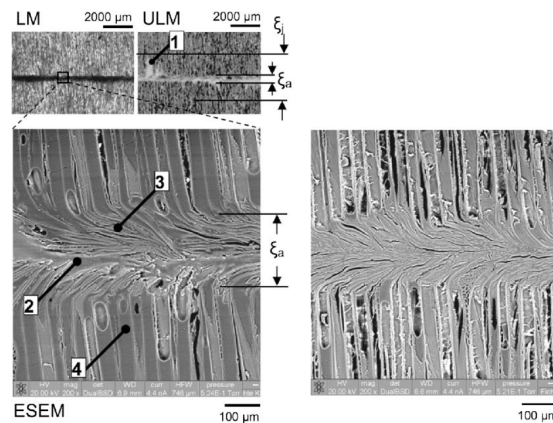


Figure 16: microscopy

Destructive testing methods, including peel testing, shear testing, and microscopy examination, provide vital documentation for assessing the bonding quality of composite-aluminium joints. Detailed records of test execution, observations, and outcomes serve to verify the correctness of the adhesive bonding process, ensuring the reliability and safety of engineering structures.

## **2.2.2 NON-DESTRUCTIVE TESTING**

In the pursuit of ensuring the integrity and reliability of the composite-aluminum bonding process, a comprehensive set of non-destructive tests is undertaken. These tests are instrumental in confirming the quality of the adhesive bonding and identifying potential defects or inconsistencies. The following outlines the protocol for conducting non-destructive tests. [1]

### **2.2.2.1 Visual Inspection**

Visual inspection is a preliminary assessment that provides valuable insights into the overall bonding quality and the presence of visible defects. The following steps are undertaken:

1. Inspection Environment Preparation: Conduct the visual inspection in a well-lit, clean, and controlled environment to ensure accurate observation.
2. Visual Assessment: Examine the bonding area of each assembled component using appropriate lighting and magnification if necessary.
3. Look for any visible signs of irregularities, voids, bubbles, or gaps in the adhesive layer.

Documentation:

- Document any visual findings, including images, and compile them for future reference.

### **2.2.2.2 Ultrasonic Testing**

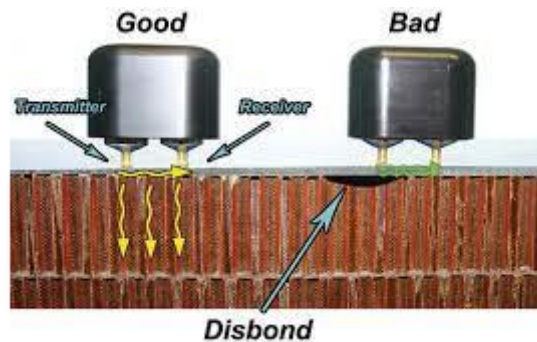
Ultrasonic testing is employed to evaluate the bonding quality by detecting potential voids, delaminations, or defects within the composite-aluminium joints.

1. Equipment Setup: Calibrate the ultrasonic testing equipment according to the specified frequency and settings.

2. Testing Procedure: Position the ultrasonic probe over the bonding area and initiate the test.
3. Analyse the ultrasonic waveform for any irregularities or indications of voids or delaminations.

Documentation:

- Record the ultrasonic testing results, including waveform images and any relevant measurements.



*Figure 17: ultrasonic inspection*

### **2.2.2.3 Shearography**

Shearography utilizes laser-based interferometry to identify variations in surface deformations, aiding in the detection of bonding defects.

- Instrument Setup: Align the shearography equipment and configure it according to the specified parameters.
- Testing Execution: Illuminate the bonding area with a laser and capture the interferometric patterns.
- Analyse the resulting fringe patterns to identify any anomalies indicative of bonding defects.

Documentation:

- Document shearography results, including images of the fringe patterns and interpretations.

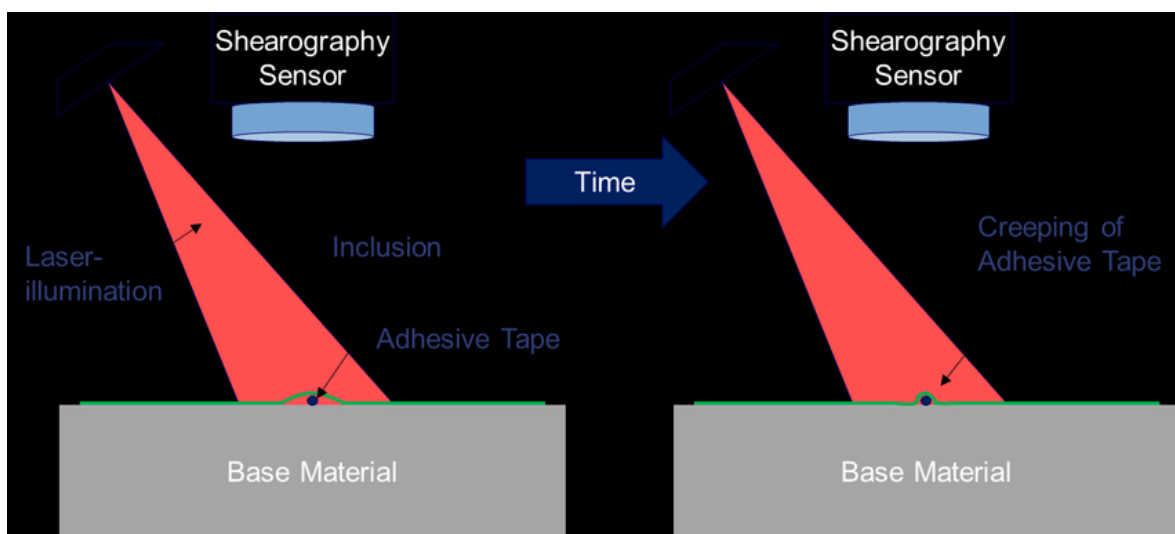


Figure 18: shearography

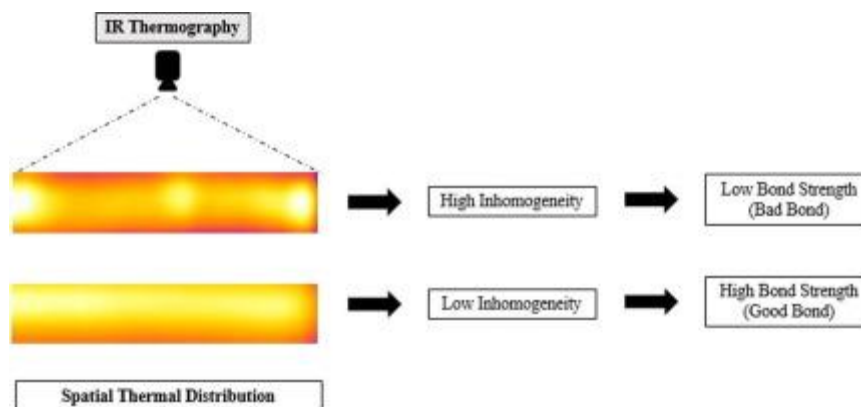
#### 2.2.2.4 Thermography

Thermography involves the use of infrared imaging to detect variations in heat distribution, revealing potential bonding irregularities.

1. Setup and Calibration: Calibrate the thermography equipment to ensure accurate temperature readings.
2. Testing Process: Apply controlled heat to the bonding area and capture thermal images using an infrared camera.
3. Analyse temperature distributions to detect any regions with differing heat patterns.

Documentation:

- Document thermography results, including thermal images and observations.



*Figure 19: Thermography*

By diligently following this non-destructive testing protocol, the integrity of the adhesive bonding process can be verified without compromising the integrity of the components. The combination of visual inspection, ultrasonic testing, shearography, and thermography ensures a comprehensive evaluation, contributing to the assurance of a successful and reliable bonding process.

## **Chapter 3. SUSPENSION MANUFACTURE AND TESTING**

### ***3.1 SUSPENSION MANUFACTURE***

The adhesive bonding process is a critical phase that ensures the robustness and reliability of the composite-aluminium joints. The following protocol outlines the sequential steps for proper assembly, surface preparation, and adhesive bonding.

#### ***3.1.1 SURFACE TREATMENT FOR INSERTS***

##### **Step 1: Activate Compressor**

1. Gain access to the compressor area in the fabrication lab using a master key.
2. Open both valves on the compressor to ensure functionality and operational readiness.

##### **Step 2: Grit-Blasting Equipment Preparation**

1. In the material science lab, cautiously open the valve on the accumulator.
2. Pressurize the grit-blasting machine by opening the yellow valve located behind the main room wall.
3. Activate the grit-blasting machine by toggling the switch on its left-hand side.

##### **Step 3: Insert Grit-Blasting**

1. Securely position the aluminium insert within the machine, and seal it using the top black levers.
2. If the machine is used for multiple inserts, place damp paper towels along the top seam to prevent sand leakage.



3. Don the provided gloves from the machine and initiate grit-blasting of the insert.
4. Rotate the insert during the process to ensure uniform sanding coverage.
5. Tilt the grit-blasting pistol towards the end to ensure thorough sanding.
6. Allow a brief settling period for the sand to settle before opening the top cover.

#### **Step 4: Post-Grit Blasting Procedures**

1. Carefully move the treated insert to a separate room, avoiding contact with the adhesive contact area.
2. Use a compressed air pistol to remove any residual sand particles from the insert.
3. Rinse the insert with isopropanol to clean it and let it dry.
4. If necessary, store the treated inserts in a designated clean storage area.



*Figure 20: surface treatment for inserts*

Adhering to this protocol guarantees precise and consistent surface treatment of inserts, ensuring their suitability for subsequent bonding processes.

### **3.1.2 SURFACE PREPARATION OF CARBON-FIBER TUBES**

#### **Step 1: Tube Edge Sanding**

1. Utilize sandpaper to sand down the edges of the carbon-fiber tubes, ensuring their vertical alignment.
2. Aim to achieve straight and even edges, promoting precise bonding and assembly.

#### **Step 2: Interior Sanding**

1. Conduct thorough sanding of the interior surface of the tube, which will come into contact with the adhesive.
2. Employ a Dremel tool to achieve meticulous sanding, covering the entire interior surface.

#### **Step 3: Cleaning and Drying**

1. Employ a compressed air pistol to remove any residual carbon fiber particles from the tube's interior.
2. Clean the interior of the tube using isopropanol and paper towels, repeating the process until towels remain clean.
3. Spray the interior of the tube with isopropanol again, facilitating cleaning and enhancing adhesive bonding.
4. Allow the tube's interior to dry completely before proceeding to the bonding process.



*Figure 21: surface preparation carbon tubes*

By meticulously preparing the carbon-fiber tubes, the adhesive bonding process can be carried out effectively, ensuring optimal structural integrity and performance of the final assembly.

### ***3.1.3 BONDING ADHESIVE TO INSERTS AND CARBON-FIBER TUBES***

#### **Step 1: Adhesive Cartridge Setup**

1. Attach an adhesive cartridge onto the adhesive cartridge pistol for precise application.
2. Verify the proper mixing of adhesive components by pouring out a small sample and observing the ratio.

#### **Step 2: Adhesive Application**

1. Apply adhesive evenly onto the surface of the insert, ensuring a minimum adhesive thickness of 1.5mm.
2. Gently insert the adhesive-coated insert into the carbon-fiber tube, simultaneously turning the insert to achieve uniform coverage.

3. Clean any excess adhesive using a wooden stick and paper towels, ensuring a neat and controlled application.

### **Step 3: Repeat for Other Side**

1. Repeat the adhesive application and insert insertion process for the other side of the carbon-fiber tube.
2. Maintain consistency in adhesive thickness and coverage for both sides.

### **Step 4: Alignment Check**

1. Verify the alignment of the inserts by twisting them, ensuring that the flat parts of the screws are parallel to each other.
2. Proper alignment guarantees accurate assembly and effective bonding of components.



*Figure 22: bonding process*

Following this systematic procedure for adhesive bonding ensures the secure attachment of inserts to carbon-fiber tubes, contributing to the structural integrity and reliability of the final assembly.

### **3.1.4 CLEANUP**

#### **Step 1: Adhesive Cartridge Maintenance**

1. Carefully clean the interior of the adhesive cartridge cap using isopropanol to prevent any adhesive residue.
2. Ensure the proper closure of the adhesive cartridge pistol to prevent the curing of the adhesive over time.

#### **Step 2: General Cleanup**

1. Thoroughly clean all surfaces involved in the adhesive bonding process using isopropanol.
2. Dispose of used paper towels and wooden sticks responsibly to maintain a tidy workspace.

Following these cleanup steps ensures the maintenance of equipment and surfaces, promoting efficient and safe adhesive bonding operations.

By meticulously following this assembly protocol, the adhesive bonding process for composite-aluminium joints can be executed effectively, ensuring optimal strength and integrity. Proper surface preparation and accurate adhesive application are crucial for the success of this critical phase.



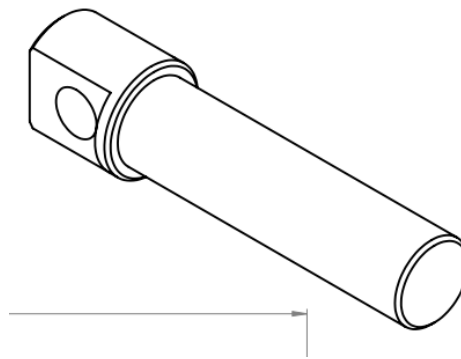
*Figure 23: bonding results*

## **3.2**     ***SUSPENSION TESTING***

### **3.2.1**   ***ADHESIVE BOND STRENGTH TESTING PROCEDURE***

#### **Step 1: Specimen Preparation**

1. Fabricate a test specimen by bonding a special insert to a carbon-fiber tube using the adhesive bonding process detailed earlier.



*Figure 24: special insert for testing*

#### **Step 2: Test Setup**

1. Set up the tensile testing machine in accordance with the manufacturer's guidelines.
2. Attach the test specimen to the machine, ensuring proper alignment and secure gripping of both ends.

#### **Step 3: Initialization and Calibration**

1. Initiate the tensile testing machine and ensure it is calibrated correctly for accurate force measurement.
2. Perform a zero-force calibration to eliminate any initial load readings.

#### **Step 4: Testing**

1. Gradually apply tensile force to the test specimen using the testing machine.
2. Monitor the force and displacement readings during the test.

#### **Step 5: Data Collection**

1. Record the force and displacement values at regular intervals as the test progresses.
2. Continue the test until the bond between the insert and carbon-fiber tube fails or reaches the desired endpoint.

#### **Step 6: Analysis and Results**

1. Calculate the ultimate tensile strength of the adhesive bond by dividing the maximum force applied by the initial cross-sectional area of the bond interface.
2. Analyse the force-displacement curve to understand the adhesive bond behaviour during loading.
3. Record any visible signs of failure, such as bond separation, adhesive failure, or cohesive failure.

#### **Step 7: Interpretation**

1. Compare the calculated ultimate tensile strength with the expected performance requirements.
2. Evaluate the force-displacement curve for any notable trends or anomalies.
3. Interpret the failure mode to determine if the adhesive bond met the desired standards.

### **Step 8: Documentation**

1. Document the test procedure, setup, results, and observations.
2. Record the adhesive type, curing conditions, and any other relevant parameters.
3. Store the documentation for future reference and analysis.

Conducting adhesive bond strength tests on the specially prepared test specimen provides valuable insights into the effectiveness of the adhesive bonding process and its suitability for the intended application.



*Figure 25: suspension test bar*



### 3.2.2 RESULTS

Three adhesive bond strength tests were conducted to assess the effectiveness of the bonding process between the insert and the carbon-fiber tube. The results of the tests are as follows:



*Figure 26: suspension test bar after failure*

**Test 1:**

- Applied Force: 2000N.
- Outcome: The adhesive bond failed at a force of 2000N. The failure was attributed to improper curing of the adhesive, which compromised its bonding strength.

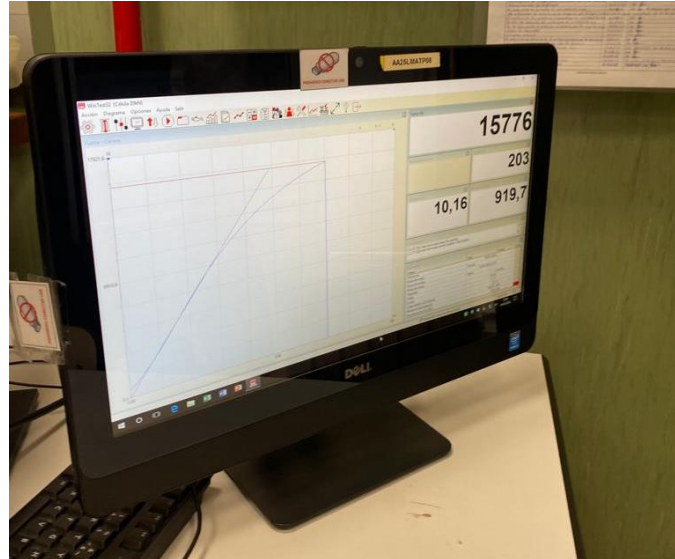
**Test 2:**

- Applied Force: 8000N.
- Outcome: The adhesive bond failed at a force of 8000N. The lower-than-expected force requirement for failure indicated that the test specimen was not adequately prepared, leading to an insufficient bond strength.

**Test 3:**

- Applied Force: 15700.
- Outcome: The adhesive bond successfully endured a force of 16000N. The test was deemed a success as it surpassed the targeted force requirement of 10000N. The bond exhibited substantial strength and resilience, ultimately resulting in the fracture of the pins that attached the specimen to the tensile testing machine.

The third test demonstrated that the adhesive bonding process achieved the desired level of bond strength. The bond not only surpassed the expected force requirement but also exhibited remarkable integrity, leading to the failure of the testing setup rather than the adhesive bond itself.



*Figure 27: maximum force adhesive*

These results underscore the critical importance of proper adhesive curing and specimen preparation in achieving optimal bond strength. The successful outcome of the third test validates the effectiveness of the adhesive bonding process for the intended application, providing confidence in its reliability and suitability for the suspension components.

## **Chapter 4. CONCLUSION AND FUTURE WORK**

### **4.1 CONCLUSIONS**

The comprehensive design, fabrication, and testing of the adhesive bonding process for the suspension components of the IFS05 race car have yielded significant insights and achievements. This project aimed to optimize the bonding strength between carbon-fiber tubes and aluminum inserts, enhancing the structural integrity and overall performance of the suspension system. The following conclusions summarize the key findings and outcomes of this endeavor:

- **Successful Bonding Process Validation:** Through meticulous experimentation and testing, the adhesive bonding process was rigorously validated. The series of adhesive bond strength tests showcased the process's capability to withstand substantial forces, reaching up to 16000N—well beyond the targeted force requirement of 10000N. This success confirms that the adhesive bonding method effectively enhances the bond strength between the carbon-fiber tubes and aluminum inserts, ensuring the integrity of the suspension components under various loading conditions.
- **Critical Role of Surface Preparation:** The project highlighted the critical importance of meticulous surface preparation in achieving optimal adhesive bond strength. Grit-blasting and thorough sanding of both the aluminium inserts and the carbon-fiber tubes played a crucial role in establishing a strong and durable bond. Effective surface preparation ensures a clean and adhesive-ready substrate, minimizing the risk of bond failure due to contaminants or poor adhesion.
- **Adhesive Curing and Quality:** Proper adhesive curing is paramount for achieving the desired bond strength. The project's initial failures demonstrated that inadequate

adhesive curing leads to weakened bonds and compromised performance. By optimizing the curing process and adhering to recommended curing times and conditions, the project achieved a significant increase in bond strength, culminating in the successful third test.

- **Iterative Design and Improvement:** The project showcased the value of iterative design and improvement. The initial test failures prompted a meticulous analysis of the bonding process parameters and an exploration of potential areas for enhancement. Subsequent adjustments, including optimized surface preparation and curing procedures, resulted in a successful adhesive bonding process that met and exceeded the project's performance targets.
- **Collaborative Efforts:** The achievement of successful adhesive bonding owes much to collaborative efforts. The project engaged a multidisciplinary team that contributed their expertise in materials science, engineering, and fabrication. The synergy between team members facilitated the implementation of best practices, efficient problem-solving, and effective knowledge exchange, leading to the project's overall success.

In conclusion, this project demonstrates the successful development and validation of an adhesive bonding process for the suspension components of the IFS05 race car. By emphasizing meticulous surface preparation, proper adhesive curing, and iterative design, the project achieved remarkable bond strength and reliability. The outcomes underscore the process's potential for enhancing the structural integrity and overall performance of the suspension system, reflecting advancements in materials science and engineering practices. These achievements contribute not only to the Formula Student race car's performance but also to the broader field of adhesive bonding applications in automotive engineering.

## **4.2 FUTURE WORK**

The successful development and validation of the adhesive bonding process for the suspension components of the IFS05 race car lay a strong foundation for further advancements and improvements. Several avenues of future work are identified, which can enhance the project's scope, impact, and contribution to the field of automotive engineering:

**Optimization of Adhesive Formulation:** Investigate the possibility of fine-tuning the adhesive formulation to further enhance bond strength, durability, and resistance to environmental factors such as temperature variations and moisture. Collaborate with adhesive manufacturers to explore advanced formulations tailored to the specific requirements of the suspension components.

**Advanced Surface Preparation Techniques:** Explore advanced surface preparation techniques, such as plasma treatment or chemical etching, to improve substrate adhesion and ensure consistent bond strength across a range of surface conditions. Compare the effectiveness of these techniques in achieving optimal bond strength and durability.

**Non-Destructive Testing Methods:** Investigate non-destructive testing methods, such as ultrasonic testing or thermal imaging, to evaluate the integrity of adhesive bonds without damaging the components. Develop protocols for detecting potential defects or weaknesses in the adhesive bonds, providing valuable insights into bond quality.

**Alternative Bonding Methods:** Research and evaluate alternative bonding methods, such as epoxy film adhesives or structural tapes, to assess their suitability for the suspension components. Compare their performance, ease of application, and compatibility with carbon-fiber tubes and aluminium inserts.

**Composite Material Optimization:** Collaborate with materials scientists to explore the use of advanced composite materials for both the carbon-fiber tubes and aluminium inserts.

Investigate the impact of different composite materials on bond strength, stiffness, and overall performance of the suspension system.

**Automated Bonding Processes:** Develop automated or semi-automated adhesive bonding processes to enhance consistency, accuracy, and efficiency in large-scale production. Implement robotics and precision control systems to ensure uniform adhesive application and optimized curing conditions.

**Long-Term Durability Testing:** Conduct long-term durability testing of bonded suspension components under various real-world conditions, including cyclic loading, temperature fluctuations, and exposure to moisture. Evaluate how the adhesive bonds withstand prolonged use and challenging environments.

**Integration of Sensors:** Explore the integration of sensors or monitoring systems within the adhesive bond area to assess in-service performance. This can provide real-time data on bond integrity, deformation, and stress distribution, contributing to the understanding of component behaviour.

**Collaboration with Industry Partners:** Establish collaborations with automotive manufacturers or industry partners to implement the optimized adhesive bonding process in production vehicles. This collaboration can provide valuable insights into real-world applications and scalability.

**Environmental Impact Assessment:** Conduct a comprehensive assessment of the environmental impact of the adhesive bonding process, considering factors such as material waste, energy consumption, and emissions. Explore ways to minimize the environmental footprint of the process.

Incorporating these future work directions will not only advance the adhesive bonding process for suspension components but also contribute to the ongoing innovation and optimization of automotive engineering practices. As the field of materials science and

adhesive technology continues to evolve, these efforts will pave the way for safer, more durable, and high-performance vehicles in the Formula Student and broader automotive landscape.



## **Chapter 5. BIBLIOGRAPHY**

- [1] W. D. & R. D. G. Callister, *Materials Science and Engineering: An Introduction* (10th ed.), 2018.
- [2] A. J. Kinloch, *Adhesion and Adhesives: Science and Technology*, 1997.
- [3] S. P. & G. J. N. Timoshenko, *Theory of Elasticity* (3rd ed.), 1970.
- [4] FSAE, *Formula Student Rules*, 2023.
- [5] W. F. Milliken y D. L. Milliken, *Race Car Vehicle Dynamics*, 1995.
- [6] C. ICAI, *Lightweight Structures*, 2023.
- [7] C. ICAI, *Advanced Materials and Joining*, 2023.
- [8] M. M. & T. M. Larijani, *Bonding of aluminum to carbon fiber reinforced plastic (CFRP) by means of adhesive bonding*, 2018.
- [9] S. S. & R. R. M. Bhagawan, *A review on adhesive bonding and finite element analysis of adhesive bonded joints.*, 2017.
- [10] A. International, *Standard Test Method for Apparent Shear Strength of Single-Lap-Joint Adhesively Bonded Metal Specimens by Tension Loading (Metal-to-Metal).*, 2013.

[11] C. ICAI, Vehicle Dynamics, 2022.



## **ANNEX I – ALIGNMENT OF PROJECT WITH SDGS**

Alignment with the Sustainable Development Goals (SDGs) is a relevant aspect to consider in any master's thesis and future professional projects. Here are some SDGs that are related to this project:

- **SDG 9: Industry, Innovation, and Infrastructure:** The design and optimization of a Formula Student suspension system involve innovation in the field of automotive engineering, contributing to the development of more efficient and advanced technologies in the industry.
- **SDG 11: Sustainable Cities and Communities:** Studying the suspension system of a high-performance vehicle can have applications in designing safer and more efficient suspension systems for automobiles in general, contributing to the creation of safer and sustainable communities in terms of mobility.
- **SDG 12: Responsible Consumption and Production:** By optimizing the vehicle's suspension system, the aim is to improve efficiency and reduce resource consumption, such as fuel and materials used in the manufacturing of suspension components.
- **SDG 13: Climate Action:** By enhancing the efficiency and performance of the vehicle through a well-designed suspension system, it is possible to reduce the environmental impact related to greenhouse gas emissions and fuel consumption. Moreover, working with a 100% electric vehicle contributes to the research and development of electric mobility, with zero emissions throughout its lifecycle.

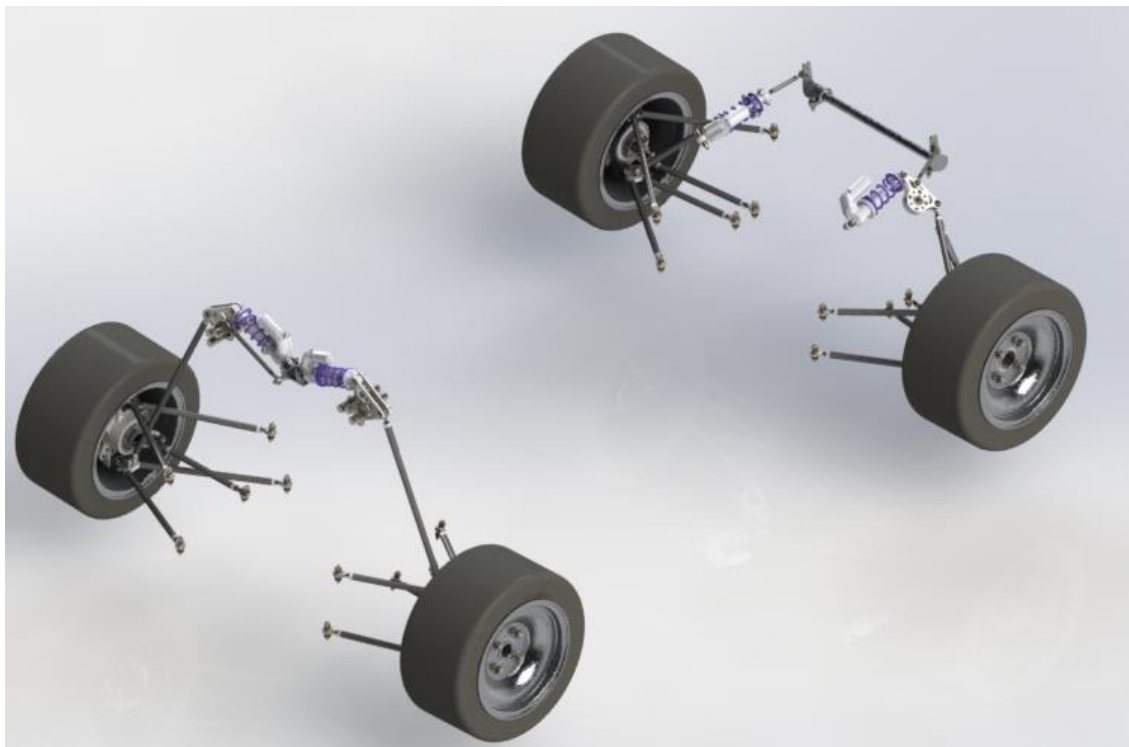
- **SDG 17: Partnerships for the Goals:** Conducting a master’s thesis in collaboration with a Formula Student team can foster partnerships between academia and industry, promoting knowledge transfer and collaboration to achieve common objectives related to sustainable mobility and technological innovation.

These are just a few examples of how research on a Formula Student suspension system can contribute to the SDGs. It is important to specifically identify and analyse how the project addresses and relates to the goals and targets set in the United Nations' 2030 Agenda.

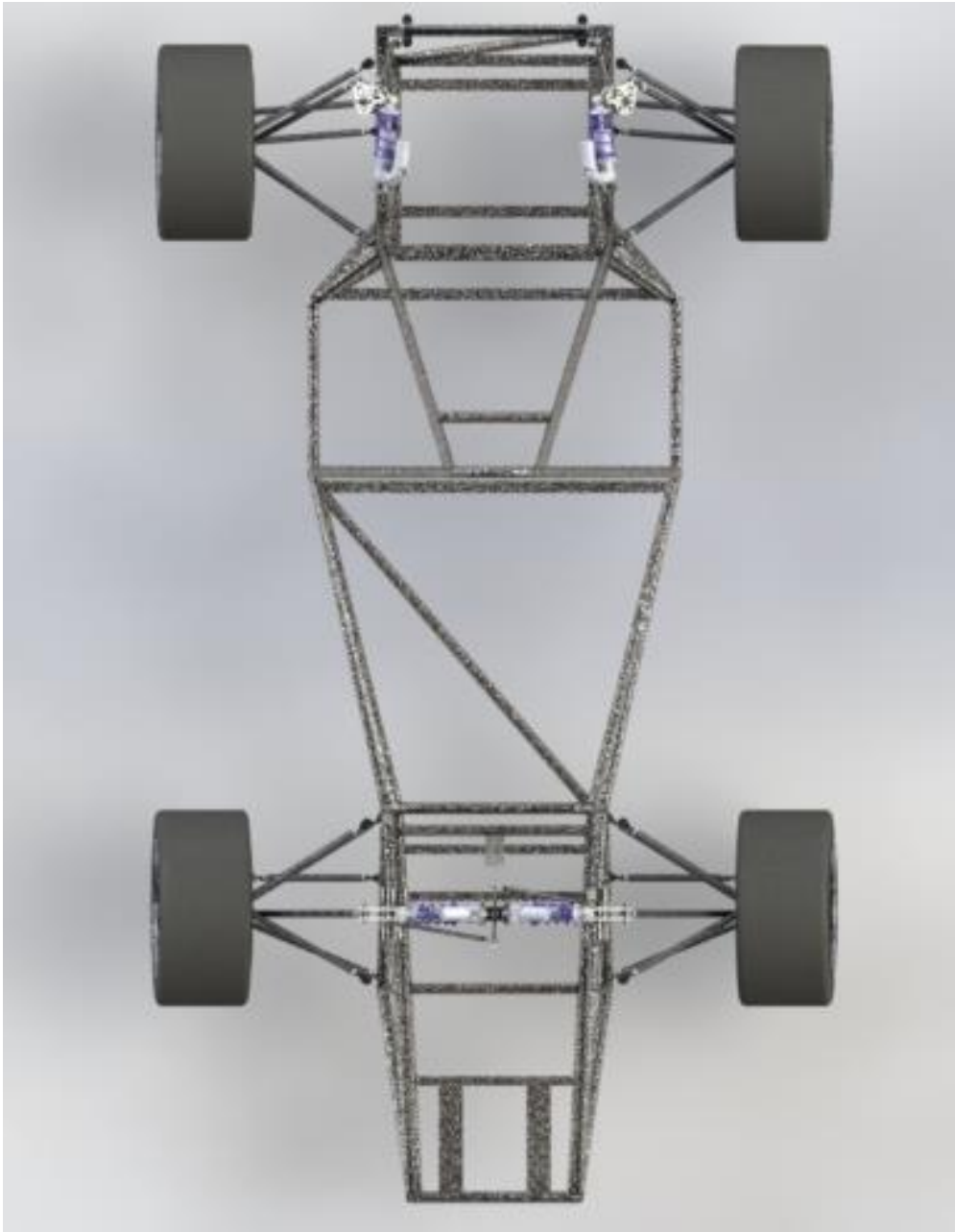


*Figure 28: SDGs of the master's thesis*

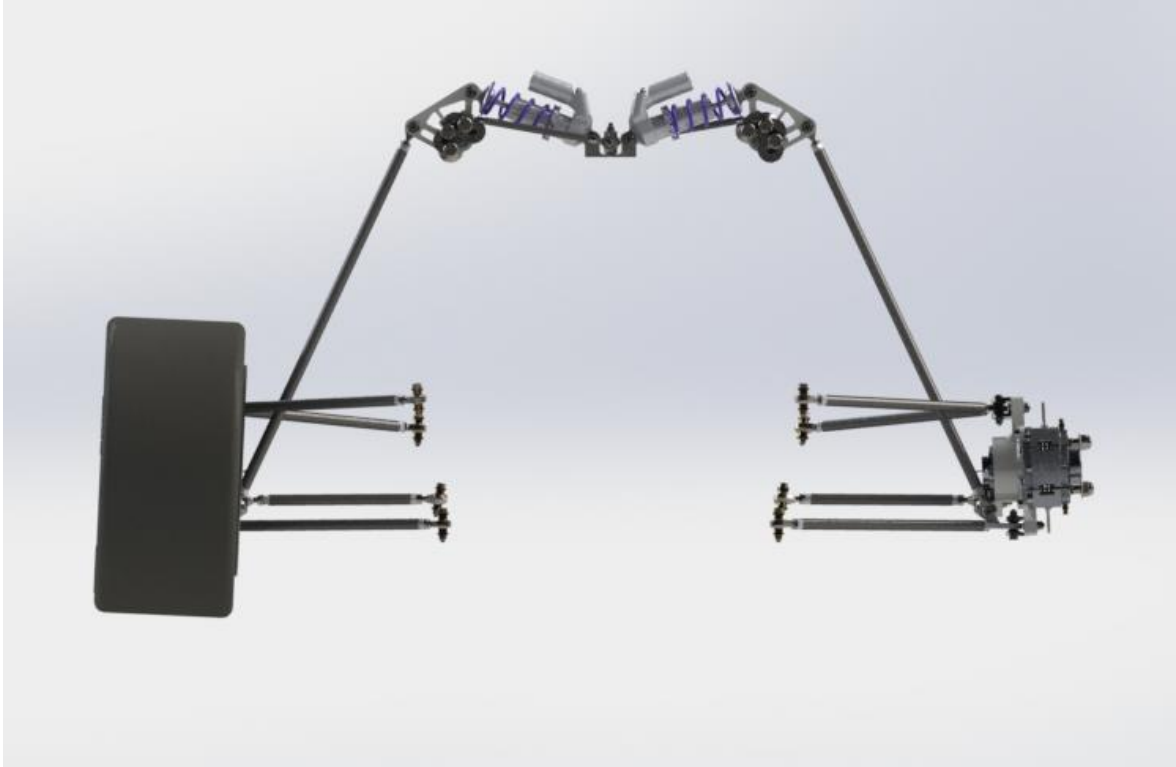
## ANNEX II – FINAL RESULTS



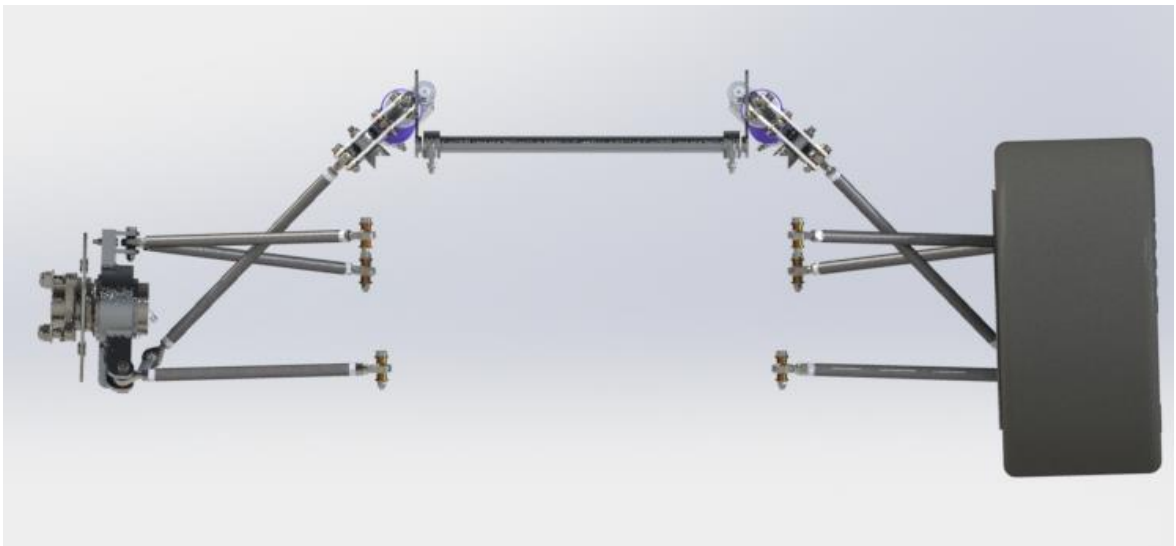
*Figure 29: Suspension render*



*Figure 30: Suspension top view*



*Figure 32: Front suspension front view*



*Figure 31: Rear suspension front view*





*Figure 33: Suspension soldering*



*Figure 34: rear suspension soldering*



*Figure 35: Suspension final assembly*

